

BUYLOG SECTION 10B

Control power and encapsulated transformers

600V class small power



Table of contents

Overview

10B-4 General and technical information

Open core and coil transformers

10B-5 Type IP overview

10B-6 Machine tool applications

10B-7 Control

10B-9 Options and fusing guide

10B-10 Wiring diagrams

10B-11 Outlines and dimensions

10B-12 CE-rated

10B-13 Ordering table

10B-14 Technical data

10B-15 Accessories

10B-16 Wiring diagrams

10B-17 Weights and dimensions

Encapsulated type QB

10B-18 General purpose single-phase NEMA 3R

10B-20 Buck-Boost autotransformers

10B-21 Buck-Boost transformers

10B-23 Dimensions and wiring diagrams

Encapsulated type QMS

10B-24 General purpose single-phase NEMA 3R

10B-25 Dimensions and wiring diagrams

General and technical information

Small power transformers
600 volts and below

Construction – Type IP, QB and QMS

Small power transformers - Type IP

Type IP small power transformers are broken down into two categories - Machine Tool and Control Power. All are manufactured using copper windings and are UL and cUL Listed. Machine Tool transformers are used when higher inrush currents are required to drive more peak power demanding loads.

Small power transformers - Types QB and QMS

QB and QMS small power transformers come standard in NEMA 3R nonventilated weatherproof enclosures. Type QB and QMS units feature encapsulated copper core and coils with integrated junction boxes for easy wiring.

Termination

Improved termination spacing and wiring compartment room gives greater flexibility in selecting various UL listed connectors for either copper or aluminum cable.

Applicable standards

Types QB and QMS are UL and cUL Listed XPTQ.E323774 and XPTQ7.E323774.

Type IP transformers are UL and cUL listed XPTQ.E323774 and XPTQ7.E323774.

ABB's dry type transformers are manufactured in an ISO 9001 certified plant.



Core and coil transformer terminal with fuse block



Core and coil transformer terminal block



Type QB, .050 kVA-3 kVA, Single-phase



Type QMS, 5 kVA-25 kVA, Single-phase



Open core and coil transformers

Machine tool and control power

Product description

Core and coil transformers for machine tools are used to provide voltage to control devices in applications where regulation and minimum space are important. Welded cores provide the highest quality electrical performance and quiet operation.

Standards: Type IP transformers conform to NEMA ST20

Listings: UL listed under UL-5085, File E2739 and E323774

Insulation classes: 150VA and below: 105°C insulation class, 55°C Rise
200VA and above: 185°C (NEMA) 180°C (UL) insulation class, 115°C Rise

Voltage regulation: All designs 2.0 kVA and below are compensated for voltage drop. Compensation ranges from 10% in the smallest rating to 3% for the largest. All machine tool designs meet or exceed NMTBA regulation requirements.

Series-multiple secondary connections: Transformers with 120/240 V secondaries (series-multiple) may be connected for 120 V, 240 V or 240/120 V three-wire. Jumpers are provided.

Overcurrent protection: Type IP transformers are low impedance transformers that require overcurrent protection for most applications. They provide for optional integral primary and/or secondary fusing.

Mounting dimensions: Type IP transformers are lightweight, small, and designed for minimum mounting dimensions. Many units will fit competitors mounting footprints.

Advantages

- Finger-safe terminals offer added protection and safety
- Pressure plate terminals ensure secure connections
- Wide variety of fusing options. See page 10B-9.



Core and coil transformer terminal with fuse block



Core and coil transformer terminal block

Key features—terminal block

- Rugged, high-impact plastic terminal block
- Full head #8 brass screws assure quick, easy terminations with maximum connection integrity
- Copper windings
- Flexible design allows input or output voltage to match any application
- CUL, UL approvals
- CE approved on page 10B-12
- Available fuse-blocks offer simple, low-cost fusing

Open core and coil transformers

Machine tool applications

Single-phase, fully-encapsulated design

60 Hz Terminal block

Input voltage	Output voltage	kVA	Wiring diagram no. ¹	Approx. net weight (lbs.)	Frame size	Ordering code
220x440, 230x460, 240x480 Volts	110, 115, 120 Volts	0.05	1	2.4	6100	9T58K0042
		0.08	1	2.8	6125	9T58K0043
		0.10	1	3.6	8100	9T58K0044
		0.15	1	5.1	8150	9T58K0045
		0.20	1	5.8	8175	9T58K0046
		0.25	1	6.5	8200	9T58K0047
		0.30	1	7.6	8250	9T58K0048
		0.38	1	7.6	8250	9T58K0049
		0.50	1	10.7	10225	9T58K0050
		0.75	1	12	12225	9T58K0051
		1	1	16.1	12300	9T58K0052
		2	1	26.7	14225	9T58K0053
		2	1	32.7	14300	9T58K0054
3	1	47.4	14475	9T58K0055		

50/60 Hz Terminal block

Input voltage	Output voltage	kVA	Wiring diagram no. ¹	Approx. net weight (lbs.)	Frame size	Ordering code
230/460/575 Volts	115/95 Volts	0.05	2	3.1	6150	9T58K0062
		0.08	2	3.6	8100	9T58K0063
		0.10	2	5.1	8150	9T58K0064
		0.15	2	6.5	8200	9T58K0065
		0.20	2	6.5	8200	9T58K0066
		0.25	2	7.6	8250	9T58K0067
		0.30	2	10.7	10225	9T58K0068
		0.38	2	10.7	10225	9T58K0069
		0.50	2	10.7	10225	9T58K0070
		0.75	2	16.1	12300	9T58K0071
		1	2	26.7	14225	9T58K0072
		1.5	2	32.7	14300	9T58K0073
		2	2	47.4	14475	9T58K0074
208/277/380 Volts	115/95 Volts	0.05	3	3.1	6150	9T58K0082
		0.08	3	3.6	8100	9T58K0083
		0.10	3	5.1	8150	9T58K0084
		0.15	3	6.5	8200	9T58K0085
		0.20	3	6.5	8200	9T58K0086
		0.25	3	7.6	8250	9T58K0087
		0.30	3	10.7	10225	9T58K0088
		0.38	3	10.7	10225	9T58K0089
		0.50	3	10.7	10225	9T58K0090
		0.75	3	16.1	12300	9T58K0091
		1	3	26.7	14225	9T58K0092
		1.5	3	32.7	14300	9T58K0093
		2	3	47.4	14475	9T58K0094

¹ See page 10B-10 for wiring diagrams.

50/60 Hz Terminal block connection

Input voltage	Output voltage	kVA	Wiring diagram no.	Approx. net weight (lbs.)	Frame size	Ordering code
230/400/460/575 Volts	115/95/125 Volts	0.25	9	12	10225	9T58K3715
		0.35	9	12	10225	9T58K3716
		0.5	9	16	12225	9T58K3717
		0.75	9	19	12300	9T58K3718
		1	9	28	14225	9T58K3719
		1.5	9	34	14300	9T58K3720
		2	9	34	14475	9T58K3721

Factory- or field-installed options

Secondary fusing—Factory- or field-installed secondary fuse clips are available. They are restricted to units with terminal strips and a single secondary voltage or secondary with one tap.

Dual primary and secondary fusing—Factory- or field-installed dual primary and secondary fuse clips are available on all units.

Open core and coil transformers

Control power

Single-phase, fully-encapsulated design

60 Hz Terminal block

Input voltage	Output voltage	kVA	Wiring diagram no. ¹	Approx. net weight (lbs.)	Frame size	Ordering code		
240x480 Volts	120/240 Volts	0.05	4	2.4	6100	9T58K2802		
		0.08	4	2.8	6125	9T58K2803		
		0.10	4	3.6	8100	9T58K2804		
		0.15	4	5.1	8150	9T58K2805		
		0.20	4	5.8	8175	9T58K2806		
		0.25	4	6.5	8200	9T58K2807		
		0.30	4	6.5	8200	9T58K2808		
		0.38	4	7.6	8250	9T58K2809		
		0.50	4	10.7	10225	9T58K2810		
		0.75	4	12	12225	9T58K2811		
		1	4	16.1	12300	9T58K2812		
		1.5	4	26.7	14225	9T58K2813		
		2	4	32.7	14300	9T58K2814		
		3	4	47.4	14475	9T58K2815		
		600 Volts	120/240 Volts	0.08	5	2.8	6125	9T58K2823
0.10	5			3.6	8100	9T58K2824		
0.20	5			5.8	8175	9T58K2826		
0.25	5			6.5	8200	9T58K2827		
0.30	5			6.5	8200	9T58K2828		
0.50	5			10.7	10225	9T58K2830		
0.75	5			12	12225	9T58K2831		
1	5			16.1	12300	9T58K2832		
1.5	5			26.7	14225	9T58K2833		
2	5			32.7	14300	9T58K2834		
3	5			47.4	14475	9T58K2835		
120x240 Volts	120/240 Volts			0.10	6	3.6	8100	9T58K2907
				0.20	6	5.8	8175	9T58K2909
				0.30	6	6.5	8200	9T58K2911
				0.50	6	10.7	10225	9T58K2913
		0.75	6	12	12225	9T58K2914		
		1	6	16.1	12300	9T58K2915		
		2	6	32.7	14300	9T58K2917		
		3	6	47.4	14475	9T58K2918		

60 Hz Terminal block

Input voltage	Output voltage	kVA	Wiring diagram no. ¹	Approx. net weight (lbs.)	Frame size	Ordering code
120 x 240 Volts	12/24 Volts	0.05	7	2.4	6100	9T58K2873
		0.075	7	2.8	6125	9T58K2874
		0.10	7	3.6	8100	9T58K2875
		0.15	7	5.1	8150	9T58K2876
		0.20	7	5.8	8175	9T58K2877
		0.25	7	6.5	8200	9T58K2878
		0.30	7	6.5	8200	9T58K2879
240 x 480 Volts	12/24 Volts	0.25	-	6.5	8200	9T58K3024
		0.05	-	2.4	6100	9T58K3164
		0.10	-	3.6	8100	9T58K4132
208 x 240 Volts	12/24 Volts	0.05	-	2.4	6100	9T58K4050
		0.10	-	3.6	8100	9T58K4051
		0.15	-	5.1	8150	9T58K4052
		0.25	-	6.5	8200	9T58K4053

50/60 Hz Terminal block

Input voltage	Output voltage	kVA	Wiring diagram no. ¹	Approx. net weight (lbs.)	Frame size	Ordering code
240 x 480 Volts	120/240 Volts	0.50	4	10.7	10225	9T58K2930
		0.75	4	16.1	12300	9T58K2931
		1	4	26.7	14225	9T58K2932
		1.5	4	32.7	14300	9T58K2933
		2	4	47.4	14475	9T58K2934
		3	4	47.4	14475	9T58K2935
		380/400/416 Volts	115/230 Volts	0.25	8	6.5
0.50	8			10.7	10225	9T58K2978
0.75	8			16.1	12300	9T58K2979
1	8			26.7	14225	9T58K2980
1.5	8			32.7	14300	9T58K2981
2	8			47.4	14475	9T58K2982
3	8			47.4	14475	9T58K2983

¹ See page 10B-10 for wiring diagrams.

² Secondary fusing not available.

Open core and coil transformers

Control power

Single-phase, fully-encapsulated design

60 Hz Leads Out Connection²

Input Voltage	Output Voltage	kVA	Wiring Diagram No. ¹	Approx. Net Weight (Lbs.)	Frame Size	Ordering code
120x240 Volts	12/24 Volts	0.05	7	2.4	6100	9T58K1873
		0.075	7	2.8	6125	9T58K1874
		0.10	7	3.6	8100	9T58K1875
		0.15	7	5.1	8150	9T58K1876
		0.20	7	5.8	8175	9T58K1877
		0.25	7	6.5	8200	9T58K1878
		0.30	7	6.5	8200	9T58K1879
		0.50	7	10.7	10225	9T58K1881
		0.75	7	12	12225	9T58K1882
		1	7	26.7	14225	9T58K1883

60 Hz Leads Out Connection²

Input Voltage	Output Voltage	kVA	Wiring Diagram No. ¹	Approx. Net Weight (Lbs.)	Frame Size	Ordering code
240 x 480 Volts	120/240 Volts	0.05	4	2.4	6100	9T58K1802
		0.075	4	2.8	6125	9T58K1803
		0.10	4	3.6	8100	9T58K1804
		0.15	4	5.1	8150	9T58K1805
		0.20	4	5.8	8175	9T58K1806
		0.25	4	6.5	8200	9T58K1807
		0.30	4	6.5	8200	9T58K1808
		0.375	4	7.6	8250	9T58K1809
		0.50	4	10.7	10225	9T58K1810
		0.75	4	12	12225	9T58K1811
		1	4	16.1	12300	9T58K1812
		1.5	4	26.7	14225	9T58K1813
		2	4	32.7	14300	9T58K1814
600 Volts	120/240 Volts	0.10	5	3.6	8100	9T58K1824
		0.20	5	5.8	8175	9T58K1826
		0.30	5	6.5	8200	9T58K1828
		0.50	5	10.7	10225	9T58K1830
		1	5	26.7	14225	9T58K1832
		2	5	32.7	14300	9T58K1834
		3	5	47.4	14475	9T58K1835

50/60 Hz Leads Out Connection²

Input Voltage	Output Voltage	kVA	Wiring Diagram No. ¹	Approx. Net Weight (Lbs.)	Frame Size	Ordering code
240 x 480 Volts	120/240 Volts	0.30	4	7.6	8250	9T58K1928
		0.50	4	10.7	10225	9T58K1930
		3	4	47.4	14475	9T58K1935
380/400/416 Volts	115/230 Volts	0.50	8	10.7	10225	9T58K1978
		0.75	8	16.1	12300	9T58K1979
		1	8	26.7	14225	9T58K1980
		1.5	8	32.7	14300	9T58K1981

¹ See page 10B-10 for wiring diagrams.



² Secondary fusing not available.

Open core and coil transformers

Options and fusing guide

Transformer fusing options

Accessory description	Ordering code
(1) Quarter-inch fuseholder	9T58K0000G24 
(1) Midget fuseholder	9T58K0000G42 
(1) H/K fuseholder	9T58K0000G10 
(2) CC fuseholder	9T58K0000G43 
(2) H/K fuseholder	9T58K0000G05 

Accessory description	Ordering code
(2) CC + (1) Quarter-inch fuseholder	9T58K0000G48 
(2) CC + (1) Midget fuseholder	9T58K0000G38 
(2) CC + (1) H/K fuseholder	9T58K0000G18 
(2) Fuse clips	9T58K0000G09 
Jumper links	9T58K0000G01

Fuse guide

Midget class CC rejection fuse

Primary voltage	Transformer continuous power rating (VA)									
	50	75	100	150	200	250	300	375	500	
	Fuse rating (amperes)									
100	1.50	2.00	3.00	4.00	3.00	4.00	5.00	6.00	8.00	
110	1.25	2.00	2.50	4.00	5.00	3.00	4.00	5.00	7.00	
120	1.25	1.60	2.50	3.00	5.00	3.00	4.00	5.00	6.00	
200	0.75	1.00	1.50	2.00	3.00	3.00	4.00	5.00	4.00	
208	0.60	1.00	1.25	2.00	2.50	3.00	4.00	5.00	4.00	
220	0.60	1.00	1.25	2.00	2.50	3.00	4.00	5.00	3.00	
230	0.60	0.80	1.25	1.60	2.50	3.00	3.00	4.00	3.00	
240	0.60	0.80	1.25	1.60	2.50	3.00	3.00	4.00	3.00	
277	0.50	0.80	1.00	1.60	2.00	2.50	3.00	4.00	5.00	
380	0.30	0.50	0.75	1.00	1.50	1.60	2.00	2.50	3.00	
400	0.30	0.50	0.75	1.00	1.50	1.60	2.00	2.50	3.00	
416	0.30	0.50	0.60	1.00	1.25	1.60	2.00	2.50	3.00	
440	0.30	0.50	0.60	1.00	1.25	1.60	2.00	2.50	3.00	
460	0.30	0.40	0.60	0.80	1.25	1.60	1.60	2.00	3.00	
480	0.30	0.40	0.60	0.80	1.25	1.50	1.60	2.00	3.00	
550	0.25	0.40	0.50	0.80	1.00	1.25	1.60	2.00	2.50	
575	0.25	0.30	0.50	0.75	1.00	1.25	1.50	1.60	2.50	
600	0.25	0.30	0.50	0.75	1.00	1.25	1.50	1.60	2.50	

For motor control circuits fusing, refer to NEC 430-72.

Secondary fuse selection

Glass fuse

Secondary voltage	Transformer continuous power rating (VA)													
	50	75	100	150	200	250	300	375	500	750	1000	1500	2000	3000
	Fuse rating (amperes)													
12	6.00	10.00	12.00	15.00	20.00	25.00	30.00	-	-	-	-	-	-	-
24	3.00	5.00	6.00	10.00	12.00	12.00	15.00	-	25.00	-	-	-	-	-
36	2.00	3.00	4.00	6.00	8.00	10.00	12.00	-	15.00	-	-	-	-	-
48	1.50	2.50	3.00	5.00	6.00	8.00	10.00	12.00	12.00	-	-	-	-	-
95	0.80	1.25	1.60	2.50	3.00	4.00	5.00	6.00	8.00	12.00	15.00	20.00	25.00	-
110	0.75	1.00	1.50	2.00	3.00	3.00	4.00	5.00	7.00	10.00	12.00	20.00	25.00	30.00
115	0.60	1.00	1.25	2.00	2.50	3.00	4.00	5.00	7.00	10.00	12.00	20.00	20.00	30.00
120	0.60	1.00	1.25	2.00	2.50	3.00	4.00	5.00	6.00	10.00	12.00	15.00	20.00	30.00
208	0.40	0.60	0.80	1.00	1.60	2.00	2.00	3.00	4.00	6.00	8.00	12.00	15.00	20.00
220	0.30	0.50	0.75	1.00	1.50	1.60	2.00	2.50	3.00	5.00	7.00	10.00	12.00	20.00
230	0.30	0.50	0.60	1.00	1.25	1.60	2.00	2.50	3.00	5.00	7.00	10.00	12.00	20.00
240	0.30	0.50	0.60	1.00	1.25	1.60	2.00	2.50	3.00	5.00	6.00	10.00	12.00	15.00

Open core and coil transformers

Machine tool applications

Control power

Wiring diagrams

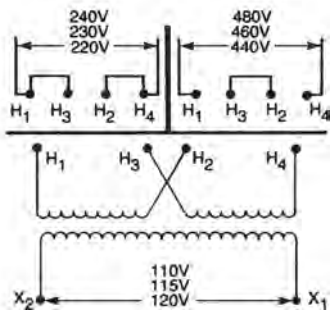

Diagram 1

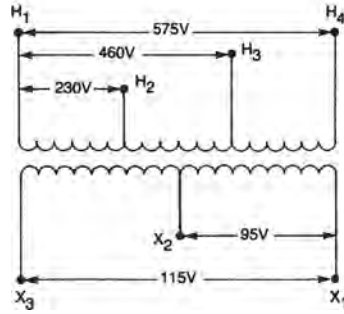

Diagram 2

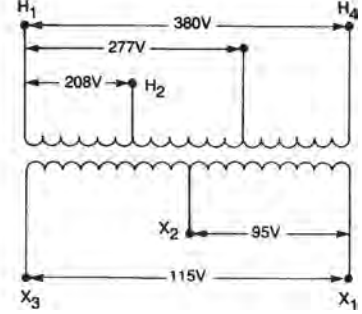

Diagram 3

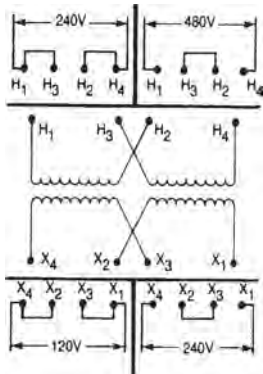

Diagram 4

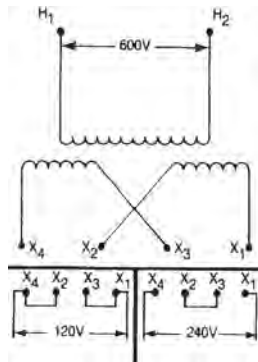

Diagram 5

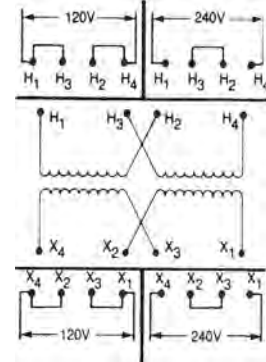

Diagram 6

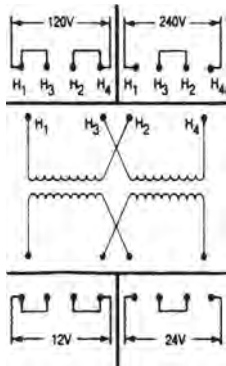

Diagram 7

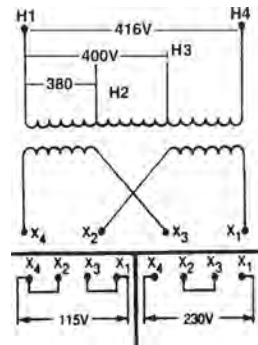

Diagram 8

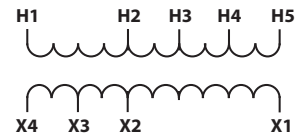

Diagram 9

Open core and coil transformers

Outlines and dimensions
6, 8, 10, 12 And 14 frames

Terminal block and leads out connection style

Frame size	Style	Outline drawing	Net weight (lbs.)	A depth (in.)	B width (in.)	C height (in.)	E mounting depth (in.)	F mounting width (in.)	Mounting slot in (in.)
6100	AA	303B947	2.6	4	3.06	2.68	2.16	2.5	0.219x0.750
	AB			3.25					
6125	AA	303B947	3	4.25	3.06	2.68	2.41	2.5	0.219x0.750
	AB			3.5					
6150	AA	303B947	3.4	4.5	3.06	2.68	2.66	2.5	0.219x0.750
	AB			3.75					
8100	AA	303B947	3.9	4.12	3.81	3.28	2.16	3.12	0.219x0.750
	AB			3.42					
8150	AA	303B947	5.5	4.62	3.81	3.28	2.66	3.12	0.219x0.750
	AB			3.92					
8175	AA	303B947	6.3	4.88	3.81	3.28	2.91	3.12	0.219x0.750
	AB			4.18					
8200	AA	303B947	7	5.12	3.81	3.28	3.16	3.12	0.219x0.750
	AB			4.42					
8250	AA	303B947	8.3	5.62	3.81	3.28	3.66	3.12	0.219x0.750
	AB			4.92					
10225	AA/AB	303B947	11.6	5.62	4.56	3.9	3.38	3.75	0.297x0.580
12225	AA/AB	303B947	13	5.88	5.31	4.56	3.38	4	0.297x0.580
12300	AA/AB	303B947	17.5	6.62	5.31	4.56	4.13	4	0.297x0.580
14225	AA/AB	303B947	29	6.5	6.81	5.81	3.38	5.5	0.297x0.580
14300	AA/AB	303B947	35.5	7.25	6.81	5.78	4.13	5.5	0.297x0.580
14475	AA/AB	303B947	51.5	9	6.81	5.81	5.88	5.5	0.297x0.580

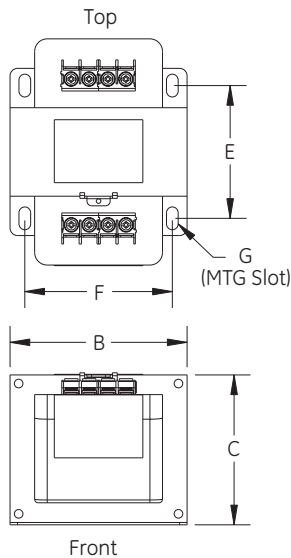

Style AA (Terminal Blocks)

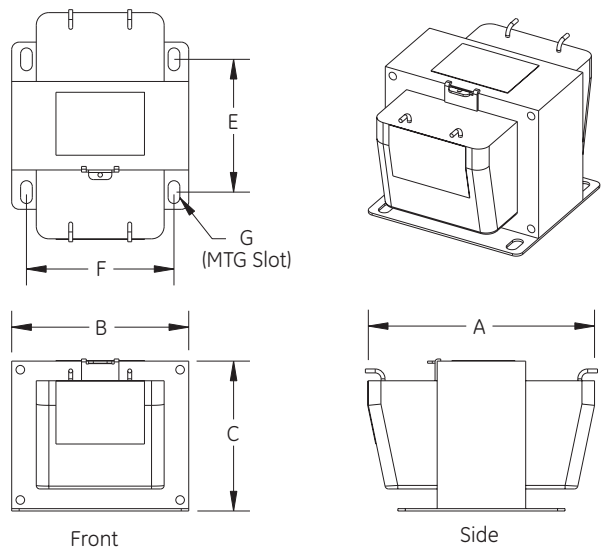

Style AB (Leads Out)

Open core and coil transformers

CE-rated

Application

This product is designed to be incorporated into equipment manufactured for sale in the European Community. This product is in conformity with the European Standard: EN 60 742, 1995 per the provisions of the Low Voltage (LV) Directive 73/23/EEC in 1973 as amended by 93/68/EEC in 1995.

The Type "IP" CE offering utilizes all copper windings, which are encapsulated in a hardened epoxy, making the winding impervious to the elements. These designs are rated at 55° C rise with a 40° C ambient. Standard on these designs are terminal block covers. These provide added protection from current carrying terminals. These designs incorporate customer friendly connection on rugged high-impact molded terminal blocks.

Factory- or field-installed options

Available as an option are two fuse blocks that have fuse covers that provide the touch safety like the terminal blocks. These can be ordered factory-installed or as kits.

Besides being CE rated, these designs are both UL and C-UL listed.

50/60 Hz

Input voltage	Output voltage	kVA	Approx. net weight (lbs.)	Frame size	Ordering code
230/400 Volts	12/24 Volts	0.025	3	6100	9T58E0020
		0.05	4	6150	9T58E0021
		0.075	4	8100	9T58E0023
		0.1	5	8150	9T58E0024
		0.15	7	8200	9T58E0025
		0.2	12	10225	9T58E0026
		0.25	12	10225	9T58E0027
		0.3	12	10225	9T58E0028
		0.375	16	12225	9T58E0029
	24/48 Volts	0.05	4	6150	9T58E0061
		0.075	4	8100	9T58E0063
		0.1	5	8150	9T58E0064
		0.15	7	8200	9T58E0065
		0.2	12	10225	9T58E0066
		0.5	19	12300	9T58E0071
		0.75	28	14225	9T58E0073
	220/380, 230/400, 240/415 Volts	110/220, 115/230, 120/240 Volts	0.025	3	6100
0.05			4	6150	9T58E0151
0.075			4	8100	9T58E0153
0.1			5	8150	9T58E0154
0.15			7	8200	9T58E0155
0.2			12	10225	9T58E0156
0.25			12	10225	9T58E0157
0.3			12	10225	9T58E0158
0.375			16	12225	9T58E0159
0.5			19	12300	9T58E0161
0.75			28	14225	9T58E0163
1			34	14300	9T58E0164
1.5			45	14475	9T58E0165
200/400/480 Volts			120 Volts	0.25	12
400/480 Volts	120/200 Volts	1.5	45	14475	9T58E0507
380/400/415/480/528 Volts	24/48 Volts	0.3	12	10225	9T58E2000
		0.5	6	8175	9T58E2001
200/208/220/230/240 Volts	24/48 Volts	0.3	12	10225	9T58E2002

Open core and coil transformers

Ordering table



T4100PSF1

50/60 Hz, RoHS and REACH compliant

Primary voltage(s)	Secondary voltage(s)	VA	Wiring diagram	Approx. net weight (lb)	Ordering code	ABB product ID
575	24	45	D	2.6	T6045SF	1TQY200060X0004
	115	75	C	3.5	T6075PS1	1TQY200060X0009
		100	C	4.2	T6100PS1	1TQY200060X0013
		150	C	5.9	T6150PS1	1TQY200060X0016
		200	C	7.5	T6200PS1	1TQY200060X0019
		250	C	9.5	T6250PS1	1TQY200060X0021
350	C	9.3	T6350PS1	1TQY200060X0027		
460/230/208, 480/240, 440/220/200	115/24	45	A	3.5	T4045SF1	1TQY200060X0078
		50	A	3.5	T4050PSF1	1TQY200060X0077
		75	A	4.2	T4075PSF1	1TQY200060X0071
		100	A	6.7	T4100PSF1	1TQY200060X0067
		300	A	14.1	TC4300F1	1TQY200060X0069
575/460/230	115-95	3000	G	77.1	T63K1	1TQY200060X0023
460/230/208, 480/240, 440/220/200	115	750	B	28.9	X4750PS1	1TQY200060X0064
		1000	B	37	X41K1	1TQY200060X0041
		2000	B	51.6	X42K1	1TQY200060X0048
		3000	B	77.1	X43K1	1TQY200060X0055
		5000	B	114.6	X45K1	1TQY200060X0060
	115/24	50	A	3.5	X4050PSF1	1TQY200060X0035
		75	A	4.2	X4075PSF1	1TQY200060X0038
		150	A	7.9	X4150PSF1	1TQY200060X0045
		200	A	9.5	X4200PSF1	1TQY200060X0049
		250	A	11.3	X4250PSF1	1TQY200060X0052
		300	A	14.1	X4300PSF1	1TQY200060X0056
		350	A	14.1	X4350PSF1	1TQY200060X0058
		500	A	23.1	X4500PSF1	1TQY200060X0061

Open core and coil transformers

Technical data

Technical data

Ordering code	ABB product ID	Temp rise °C	Insulation system	Primary fuse holder	Secondary fuse clip	Primary fuse & quantity	Secondary fuse & quantity	Covers	UL	CSA	CUL	CE mark (IEC)
T6045SF	1TQY200060X0004	55	105	-	Yes	-	1	-	Yes	Yes	-	-
T6075PS1	1TQY200060X0009	55	105	Yes	Yes	2	1	-	Yes	Yes	-	-
T6100PS1	1TQY200060X0013	55	105	Yes	Yes	2	1	-	Yes	Yes	-	-
T6150PS1	1TQY200060X0016	55	105	Yes	Yes	2	1	-	Yes	Yes	-	-
T6200PS1	1TQY200060X0019	55	105	Yes	Yes	2	1	-	Yes	Yes	-	-
T6250PS1	1TQY200060X0021	55	105	Yes	Yes	2	1	-	Yes	Yes	-	-
T6350PS1	1TQY200060X0027	55	105	Yes	Yes	2	1	-	Yes	Yes	-	-
T4045SF1	1TQY200060X0078	55	105	-	Yes	-	1	-	Yes	Yes	-	-
T4050PSF1	1TQY200060X0077	55	105	Yes	Yes	2	1	-	Yes	Yes	-	-
T4075PSF1	1TQY200060X0071	55	105	Yes	Yes	2	1	-	Yes	Yes	-	-
T4100PSF1	1TQY200060X0067	55	105	Yes	Yes	2	1	-	Yes	Yes	-	-
T63K1	1TQY200060X0023	120	180	-	-	-	-	-	Yes	Yes	-	-
TC4300F1	1TQY200060X0069	80	130	-	-	-	-	Yes	Yes	-	Yes	Yes
X41K1	1TQY200060X0041	80	130	-	Yes	-	1	-	Yes	Yes	-	-
X42K1	1TQY200060X0048	120	180	-	Yes	-	1	-	Yes	Yes	-	-
X43K1	1TQY200060X0055	120	180	-	-	-	-	-	Yes	Yes	-	-
X45K1	1TQY200060X0060	120	180	-	-	-	-	-	Yes	Yes	-	-
X4750PS1	1TQY200060X0064	80	130	Yes	Yes	2	1	-	Yes	-	Yes	-
X4050PSF1	1TQY200060X0035	80	130	Yes	Yes	2	1	-	Yes	-	Yes	-
X4075PSF1	1TQY200060X0038	55	105	Yes	Yes	2	1	-	Yes	-	Yes	-
X4150PSF1	1TQY200060X0045	80	130	Yes	Yes	2	1	-	Yes	-	Yes	-
X4200PSF1	1TQY200060X0049	80	130	Yes	Yes	2	1	-	Yes	-	Yes	-
X4250PSF1	1TQY200060X0052	80	130	Yes	Yes	2	1	-	Yes	-	Yes	-
X4300PSF1	1TQY200060X0056	80	130	Yes	Yes	2	1	-	Yes	-	Yes	-
X4350PSF1	1TQY200060X0058	80	130	Yes	Yes	2	1	-	Yes	-	Yes	-
X4500PSF1	1TQY200060X0061	80	130	Yes	Yes	2	1	-	Yes	-	Yes	-

Open core and coil transformers

Accessories

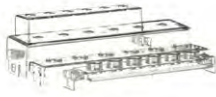

TPTC-2002

Description	UL	Approx. product net weight (lbs.)	Ordering code	ABB product ID
Primary Fuse Kit, Class CC, 2pole	Yes	0.2	FKTP-1001	1TQY000000P0010
IP20, 4-position, clear, terminal covers, master pack of 10	Yes	0.5	TPTC-2001	1TQY000000P0011
IP20, 6-position, clear, terminal covers, master pack of 10	Yes	0.5	TPTC-2002	1TQY000000P0012
IP20 Primary Class CC Fuse Cover, 2pole, master pack of 10	Yes	0.5	TPTC-2006	1TQY000000P0013

Open core and coil transformers

Wiring diagrams

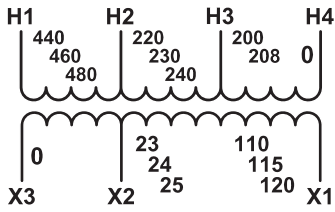

Diagram A

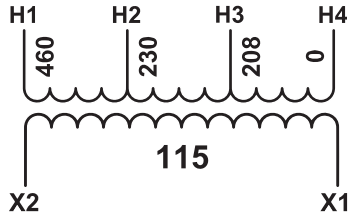

Diagram B

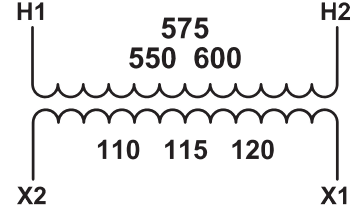

Diagram C

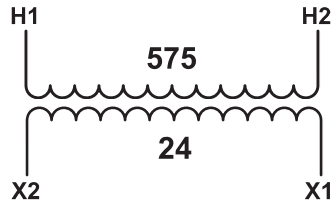

Diagram D

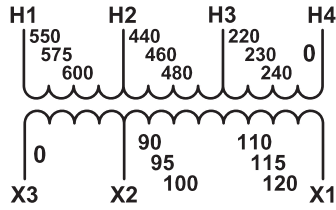
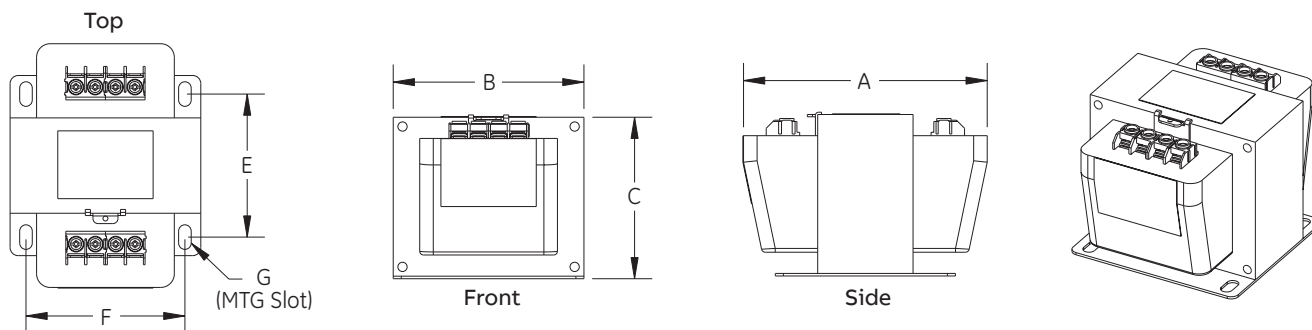

Diagram G

Open core and coil transformers

Weights and dimensions

ABB prod. ID	Ordering code	A depth (in)	B width (in)	C height (in)	Approx. product net weight (lb.)	Approx. package net length (in)	Approx. package net width (in)	Approx. package net height (in)	Approx. package net weight (lb)
1TQY200060X0078	T4045SF1	3.9	3	3.3	3.5	7.3	5.8	4.8	4.3
1TQY200060X0077	T4050PSF1	3.9	3	4.1	3.5	7.3	5.8	4.8	4.3
1TQY200060X0071	T4075PSF1	3.5	3.4	4.4	4.2	7.3	5.8	4.8	5
1TQY200060X0067	T4100PSF1	3.9	3.8	4.7	6.7	7.3	5.8	4.8	7.5
1TQY200060X0004	T6045SF	3.4	3	3.3	2.6	7.3	5.8	4.8	3.4
1TQY200060X0009	T6075PS1	3.9	3	4.1	3.5	7.3	5.8	4.8	4.3
1TQY200060X0013	T6100PS1	3.5	3.4	4.4	4.2	7.3	5.8	4.8	5
1TQY200060X0016	T6150PS1	4.3	3.8	4.7	5.9	7.3	5.8	4.8	6.7
1TQY200060X0019	T6200PS1	3.9	4.5	5.3	7.5	6.8	6.5	10.3	8.3
1TQY200060X0021	T6250PS1	4.2	4.5	5.3	9.5	6.8	6.5	10.3	10.3
1TQY200060X0027	T6350PS1	5.1	4.5	5.3	9.3	10.3	6.5	6.8	10.1
1TQY200060X0023	T63K1	8.7	9	7.7	77.1	15	14.5	14.5	77.9
1TQY200060X0069	TC4300F1	6.2	5.3	5	14.1	10.3	6.5	6.8	14.9
1TQY200060X0035	X4050PSF1	3.9	3	4.1	3.5	7.3	5.8	4.8	4.3
1TQY200060X0038	X4075PSF1	3.5	3.4	4.4	4.2	7.3	5.8	4.8	5
1TQY200060X0045	X4150PSF1	4.3	3.8	4.7	7.9	7.3	5.8	4.8	8.2
1TQY200060X0041	X41K1	7.5	6.4	5.5	37	10.8	10.5	10.5	37.8
1TQY200060X0049	X4200PSF1	4.2	4.5	5.3	9.5	6.8	6.5	10.3	10.3
1TQY200060X0052	X4250PSF1	4.6	4.5	5.3	11.3	6.8	6.5	10.3	12.1
1TQY200060X0048	X42K1	8.2	6.8	6.3	51.6	10.8	10.5	10.5	52.4
1TQY200060X0056	X4300PSF1	6.2	5.3	6	14.1	10.3	6.5	6.8	14.9
1TQY200060X0058	X4350PSF1	6.2	5.3	6	14.1	10.3	6.5	6.8	14.9
1TQY200060X0055	X43K1	8.5	9	7.5	77.1	15	14.5	14.5	77.9
1TQY200060X0061	X4500PSF1	7.2	5.3	6	23.1	10.3	6.5	6.8	23.9
1TQY200060X0060	X45K1	10.4	9	10	114.6	15	14.5	14.5	115.4
1TQY200060X0064	X4750PS1	7	5.3	6	28.9	10.3	6.5	6.8	29.7



General purpose encapsulated

Single-phase NEMA 3R

Type QB up to 3 kVA

QB small power transformers come standard in NEMA 3R nonventilated weatherproof enclosures. These units feature encapsulated copper core and coils with integrated junction boxes for easy wiring. Improved termination spacing and wiring compartment room gives greater flexibility in selecting various UL listed connectors for either copper or aluminum cable.



Type QB, .050 kVA-3 kVA, Single-phase

.050 - 3 kVA indoor/outdoor Type QB UL Listed C-UL Listed

Input voltage	Output voltage	kVA	Frequency (Hz)	Taps	Wiring diagram no. ¹	Weight (lbs)	Frame size	Ordering code
240 x 480 Volts, 480 Volts	120/240 Volts	0.05	60	No Taps	1	6	6100	9T51B0002
		0.05	50/60	No Taps	1	6	6100	9T51B0502
		0.075	60	No Taps	1	6	6200	9T51B0003
		0.075	50/60	No Taps	1	6	6200	9T51B0503
		0.1	60	No Taps	1	6	6200	9T51B0004
		0.1	50/60	No Taps	1	6	6200	9T51B0504
		0.15	60	No Taps	1	10	8175	9T51B0005
		0.15	50/60	No Taps	1	10	8175	9T51B0505
		0.25	60	No Taps	1	10	8175	9T51B0007
		0.25	50/60	No Taps	1	10	8200	9T51B0507
		0.5	60	No Taps	1	16	10200	9T51B0008
		0.5	50/60	No Taps	1	20	10225	9T51B0508
		0.75	60	No Taps	1	25	12200	9T51B0009
		0.75	50/60	No Taps	1	25	12225	9T51B0509
		1	60	No Taps	1	25	12225	9T51B0010
		1	50/60	No Taps	1	30	12275	9T51B0510
		1.5	60	No Taps	1	40	14200	9T51B0011
		1.5	50/60	No Taps	1	40	14225	9T51B0511
		2	60	No Taps	1	45	14250	9T51B0012
		2	50/60	No Taps	1	50	14300	9T51B0512
240 x 480 Volts, 480 Volts	120/240 Volts	3	60	No Taps	1	55	14350	9T51B0013
		3	50/60	No Taps	1	60	14400	9T51B0513
		0.5	50/60	(-2: 5.0%)	2	20	10225	9T51B0548
		0.75	50/60	(-2: 5.0%)	2	25	12200	9T51B0549
		1	60	(-2: 5.0%)	2	25	12225	9T51B0050
		1	50/60	(-2: 5.0%)	2	30	12275	9T51B0550
		1.5	60	(-2: 5.0%)	2	40	14200	9T51B0051
		1.5	50/60	(-2: 5.0%)	2	40	14225	9T51B0551
		2	60	(-2: 5.0%)	2	45	14250	9T51B0052
		2	50/60	(-2: 5.0%)	2	50	14300	9T51B0552
240 x 480 Volts, 480 Volts	120/240 Volts	3	60	(-2: 5.0%)	2	55	14350	9T51B0053
		3	60	(+2, -2: 2.5%)	3	55	14350	9T51B0135
		3	50/60	(-2: 5.0%)	2	60	14400	9T51B0553
		0.05	60	No Taps	5	6	6100	9T51B0082
		0.075	60	No Taps	5	6	6200	9T51B0083
		0.1	60	No Taps	5	6	6200	9T51B0084
		0.1	50/60	No Taps	5	6	6200	9T51B0584
		0.15	60	No Taps	5	10	8175	9T51B0085
		0.25	60	No Taps	5	10	8175	9T51B0087
		0.25	50/60	No Taps	5	10	8200	9T51B0587
240 x 480 Volts, 480 Volts	120/240 Volts	0.5	60	No Taps	5	16	10200	9T51B0088
		0.5	50/60	(-2: 5.0%)	2	20	10225	9T51B0568
		0.75	60	No Taps	5	25	12200	9T51B0089
		0.75	50/60	(-2: 5.0%)	2	25	12200	9T51B0569
		1	60	(-2: 5.0%)	2	25	12225	9T51B0070
		1	60	No Taps	5	25	12225	9T51B0090
		1	50/60	(-2: 5.0%)	2	30	12275	9T51B0570
		1.5	60	(-2: 5.0%)	2	40	14200	9T51B0071
		1.5	60	No Taps	5	40	14200	9T51B0091
		1.5	50/60	(-2: 5.0%)	2	40	14225	9T51B0571
240 x 480 Volts, 480 Volts	120/240 Volts	2	60	(-2: 5.0%)	2	45	14250	9T51B0072
		2	60	No Taps	5	45	14250	9T51B0092
		2	50/60	(-2: 5.0%)	2	50	14300	9T51B0572
		2	50/60	No Taps	-	50	14300	9T51B0592
		3	60	(-2: 5.0%)	2	55	14350	9T51B0073
		3	60	No Taps	5	55	14350	9T51B0093
		3	50/60	(-2: 5.0%)	2	60	14400	9T51B0573
		3	50/60	No Taps	-	60	14400	9T51B0593

¹ See page 10B-23 for wiring diagrams.

General purpose encapsulated

Single-phase NEMA 3R

Type QB up to 3 kVA

.050 - 3 kVA indoor/outdoor Type QB UL Listed C-UL Listed

Input voltage	Output voltage	kVA	Frequency (Hz)	Taps	Wiring diagram no. ¹	Weight (lbs)	Frame size	Ordering code
120 x 240 Volts	120/240 Volts	0.05	60	No Taps	1	6	6100	9T51B0022
		0.1	60	No Taps	1	6	6200	9T51B0024
		0.25	60	No Taps	1	10	8175	9T51B0027
		0.5	60	No Taps	1	16	10200	9T51B0028
		0.75	60	No Taps	1	25	12200	9T51B0029
		1	60	No Taps	1	25	12225	9T51B0030
		1.5	60	No Taps	1	40	14200	9T51B0031
		2	60	No Taps	1	45	14250	9T51B0032
208 Volts	120/240 Volts	3	60	No Taps	1	60	14400	9T51B0033
		0.5	60	No Taps	4	16	10200	9T51B0158
		0.75	60	No Taps	4	25	12200	9T51B0159
		1	60	No Taps	4	25	12225	9T51B0160
		2	60	No Taps	4	45	14250	9T51B0156
		3	60	No Taps	4	55	14350	9T51B0157

.050 - 3 kVA indoor/outdoor Type QB UL Listed C-UL Listed

Input voltage	Output voltage	kVA	Frequency (Hz)	Taps	Wiring diagram no. ¹	Weight (lbs)	Frame size	Ordering code
277 Volts	120/240 Volts	0.25	60	(-2: 5.1%)	2	10	8175	9T51B0187
		0.5	60	(-2: 5.1%)	2	16	10200	9T51B0188
		0.75	60	(-2: 5.1%)	2	25	12200	9T51B0189
		1	60	(-2: 5.1%)	2	30	12275	9T51B0190
		1.5	60	(-2: 5.1%)	2	40	14200	9T51B0191
		2	60	(-2: 5.1%)	2	45	14250	9T51B0192
		3	60	(-2: 5.1%)	2	55	14350	9T51B0193
380/400/416 Volts	120/240 Volts	0.15	50/60	No Taps	2	10	8175	9T51B0165
		0.25	50/60	No Taps	2	10	8200	9T51B0167
		0.5	50/60	No Taps	2	20	10225	9T51B0168
		0.75	50/60	No Taps	2	25	12200	9T51B0169
		1	50/60	No Taps	2	30	12275	9T51B0170
		1.5	50/60	No Taps	2	40	14225	9T51B0171
		2	50/60	No Taps	2	50	14300	9T51B0172
		3	50/60	No Taps	2	60	14400	9T51B0173

¹ See page 10B-23 for wiring diagrams.

Buck-Boost

Autotransformers Encapsulated

Application

For general lighting and power service

Autotransformers are more economical than isolation transformers designed to carry the same load. Within their voltage limitations, they will perform the same function as transformers with the exception of isolating two circuits. You can use these autotransformers to obtain 120 Volts from a 240 Volt circuit, to derive a neutral on a 240 Volt, two-wire circuit, or to balance a 120/240 Volt, three-wire circuit. They also may be used in banks to create polyphase circuits. See footnotes below.

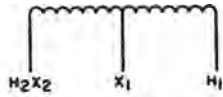

Wiring diagram: single-phase

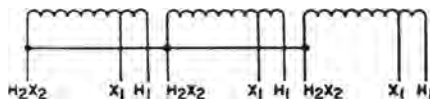

Wiring diagram: three-phase

For bucking or boosting voltage of single-phase indoor/outdoor Type QB 60 Hz UL Listed CSA Certified¹

Input voltage	Output voltage	kVA ²	Height (in)	Width (in)	Depth (in)	Approx. net weight (Lbs.)	Frame size	Ordering code
240/120 Volts	120 or 240/120 Volts (Three-Wire)	0.5	7.38	6.13	4.25	10	8175	9T51B0136
		0.75	8.38	6.88	4.88	16	10200	9T51B0137
		1	8.38	6.88	4.88	16	10200	9T51B0138
		1.5	9.63	7.88	5.5	25	12200	9T51B0139
		2	9.63	7.88	5.5	25	12225	9T51B0140
		3	11.13	9.38	6.75	40	14200	9T51B0141
		5	11.13	9.38	6.75	60	14400	9T51B0142

¹ Through 3 kVA

For bucking or boosting voltage of single-phase indoor/outdoor Type QMS 60 Hz UL Listed CSA Certified

Input voltage	Output voltage	kVA ²	Height (in)	Width (in)	Depth (in)	Approx. net weight (Lbs.)	Frame size	Ordering code
240/120 Volts	120 or 240/120 Volts (Three-Wire)	10	14.50	10.62	11.00	103	16350	9T21B4553G02
		15	17.06	10.62	11.00	147	16600	9T21B9201
		25	17.06	12.50	12.50	220	19500	9T21B9202

² kVA output at 120 Volts, two-wire, or allowable unbalance at 240/120 Volts, three-wire.

For boosting voltage of three-phase indoor/outdoor Type QB 60 Hz UL Listed

Input voltage	Output voltage	kVA ²	Height (in)	Width (in)	Depth (in)	Approx. net weight (Lbs.)	Frame size	Ordering code
208Y/120 Volts	230/133 Volts	6	7.38	6.13	4.25	10	8175	9T51B0143
		9	8.38	6.88	4.88	16	10200	9T51B0144
		15	8.38	6.88	4.88	20	10225	9T51B0145
		30	9.63	7.88	5.50	30	12275	9T51B0146
		45	11.13	9.38	6.75	40	14200	9T51B0147
		75	11.13	9.38	6.75	60	14400	9T51B0148
		6	7.38	6.13	4.25	10	8175	9T51B0150
		15	9.63	7.88	5.50	25	12200	9T51B0152
		30	11.13	9.38	6.75	40	14200	9T51B0153

³ Bank of three single-phase autotransformers to be connected wye. Dimensions and weights are for each unit in bank. Each single autotransformer is rated 1/3 of the bank kVA rating. Order three single-phase transformers for each three-phase bank.

Buck-Boost

Buck-Boost
Isolating transformers
Encapsulated

Product description

Buck boost transformers are small, single-phase, dry type distribution transformers designed and shipped as isolating transformers. They have a dual voltage primary and a dual voltage secondary. These transformers can be connected for a wide range of voltage combinations. The most common use is to buck (lower) or boost (raise) the supply voltage a small amount. Buck boost transformers comply with NEC Article 210-9, Exception 1, when field connected as an autotransformer.

ABB bucking and boosting transformers provide an economical and convenient means for bucking or boosting voltage, usually no more than $\pm 20\%$ on single- and three-phase circuits. They are compact, relatively light in weight, and can be easily installed for indoor or outdoor service.

Buck-boost transformers are employed primarily for boosting single- and three-phase circuits by connecting them as autotransformers. When connected as an autotransformer, only the low-voltage, high-current capacity secondary windings are required to carry the load. Because this load is only transformed over a small change in voltage, the buck-boost transformer can handle loads many times its nameplate kVA rating.

Beyond the typical bucking and boosting applications, the transformers with series-multiple 12/24, 24/48, or 16/32 Volt secondary windings are suitable for a wide variety of applications. Two or more units can be used in various combinations to obtain many other special voltages.

Advantages

- Efficient insulating materials permit compact size and light weight
- Dual voltage primary and dual voltage secondary for maximum versatility
- Large, front-accessible wiring compartment permits fast, easy wiring
- Convenient conduit knockouts located on side, bottom and back of wiring compartment
- Many ABB buck-boost transformers fit competitor mounting footprints
- Indoor or outdoor service

Key features

- Convenient and least expensive method of matching line voltage with equipment voltage
- More efficient than equivalent isolation transformers
- Ability to handle loads up to 20 times nameplate rating when connected as an autotransformer
- Ideal for changing line voltages by small amounts



Indoor/outdoor Type QB transformer;
single-phase

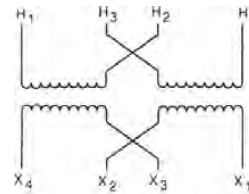

Wiring diagram for low voltage loads

- Primary voltages include 120V, 240V and 480V
- Secondary voltages include 12V, 16V, 24V, 32V, 48V
- UL and cUL Listed
- Qualified to the seismic requirements of IEEE-693-1997 and IBC-2018

Applications

- International voltage adaptation
- Commercial and industrial air conditioning
- Heating systems
- Induction motors
- Voltage line drop correction
- Landscape lighting
- Low-voltage lighting

Efficient operation of electrical equipment requires that line voltage be at or near the nameplate rating of the equipment. In order to match available line voltage (whether it be too high or low) with equipment voltage, buck-boost transformers provide the most convenient and least expensive method.

Do not use buck-boost transformers to solve a fluctuating voltage problem. They should be used to compensate for high- or low voltage conditions only when the available line voltage is reasonably constant.

Buck-Boost

Encapsulated

For bucking and boosting voltage

Single-phase indoor/outdoor Type QB 60 Hz UL Listed C-UL Listed

Input voltage	Output voltage	kVA	Height (in)	Width (in)	Depth (in)	Approx. net weight (Lbs.)	Frame size	Ordering code
120/240 Volts	12/24 Volts	0.05	6.38	5.12	3.25	6	6100	9T51B0102
		0.075	6.38	5.12	3.25	6	6200	9T51B0103
		0.1	6.38	5.12	3.25	6	6200	9T51B0104
		0.15	7.38	6.12	4.25	10	8175	9T51B0105
		0.25	7.38	6.12	4.25	10	8175	9T51B0107
		0.5	8.38	6.88	4.88	20	10225	9T51B0108
		0.75	9.62	7.88	5.50	25	12200	9T51B0109
		1	9.62	7.88	5.50	25	12225	9T51B0110
		1.5	11.12	9.38	6.72	40	14200	9T51B0111
		2	11.12	9.38	6.72	50	14300	9T51B0112
	3	-	9.38	6.72	55	14350	9T51B0113	
120/240 Volts	16/32 Volts	0.05	6.38	5.12	3.25	6	6100	9T51B0122
		0.075	6.38	5.12	3.25	6	6200	9T51B0123
		0.1	6.38	5.12	3.25	6	6200	9T51B0124
		0.15	7.38	6.12	4.25	10	8175	9T51B0125
		0.25	7.38	6.12	4.25	10	8175	9T51B0127
		0.5	8.38	6.88	4.88	20	10225	9T51B0128
		0.75	9.62	7.88	5.50	25	12200	9T51B0129
		1	9.62	7.88	5.50	30	12300	9T51B0130
		1.5	11.12	9.38	6.72	40	14200	9T51B0131
		2	11.12	9.38	6.72	50	14300	9T51B0132
	3	-	9.38	6.72	55	14350	9T51B0133	
240/480 Volts	24/48 Volts	0.05	6.38	5.12	3.25	6	6100	9T51B0202
		0.075	6.38	5.12	3.25	6	6200	9T51B0203
		0.1	6.38	5.12	3.25	6	6200	9T51B0204
		0.15	7.38	6.12	4.25	10	8175	9T51B0205
		0.25	7.38	6.12	4.25	10	8175	9T51B0207
		0.5	8.38	6.88	4.88	20	10225	9T51B0208
		0.75	9.62	7.88	5.50	25	12200	9T51B0209
		1	9.62	7.88	5.50	30	12275	9T51B0210
		1.5	11.12	9.38	6.72	40	14200	9T51B0211
		2	11.12	9.38	6.72	50	14300	9T51B0212
	3	11.12	9.38	6.72	55	14350	9T51B0213	

Single-phase indoor/outdoor Type QMS 60 Hz UL Listed C-UL Listed

Input voltage	Output voltage	kVA	Height (in)	Width (in)	Depth (in)	Approx. net weight (Lbs.)	Frame size	Ordering code
120/240 Volts	12/24 Volts	5	14.5	10.62	11	103	16350	9T21B1037G02
	16/32 Volts	5	14.5	10.62	11	115	16400	9T21B1040G02

Single-phase indoor/outdoor Type QMS 50 Hz UL Listed C-UL Listed

Input voltage	Output voltage	kVA	Height (in)	Width (in)	Depth (in)	Approx. net weight (Lbs.)	Frame size	Ordering code
120/240 Volts	16/32 Volts	5	14.5	10.62	11	127	16450	9T21B1064G02

NOTE: In addition to bucking or boosting low circuit voltages to related value, these transformers can be used as two winding transformers to supply the rated nameplate low voltages, 12 to 48 Volts, two-wire or 12/24 to 24/48 Volts, three-wire. Also available in 50/60 Hz ratings.

Dimensions and wiring diagrams

QB transformers

Frame size	Outline drawing no.	Height (in.)	Width (in.)	Depth (in.)
6100	303B920AAP001	6.38	5.12	3.25
6150	303B920AAP001	6.38	5.12	3.25
6200	303B920AAP001	6.38	5.12	3.25
8175	303B920AAP002	7.38	6.12	4.25
8200	303B920AAP002	7.38	6.12	4.25
10200	303B920AAP003	8.38	6.88	4.88
10225	303B920AAP003	8.38	6.88	4.88
12200	303B920AAP004	9.62	7.88	5.5
12225	303B920AAP004	9.62	7.88	5.5
12275	303B920AAP004	9.62	7.88	5.5
12300	303B920AAP004	9.62	7.88	5.5
14200	303B920AAP005	11.12	9.38	6.72
14225	303B920AAP005	11.12	9.38	6.72
14250	303B920AAP005	11.12	9.38	6.72
14300	303B920AAP005	11.12	9.38	6.72
14350	303B920AAP005	11.12	9.38	6.72
14400	303B920AAP005	11.12	9.38	6.72

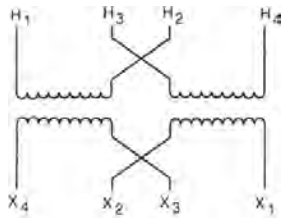

Diagram 1

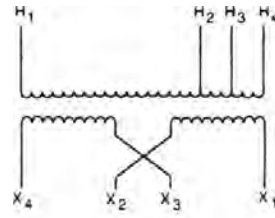

Diagram 2

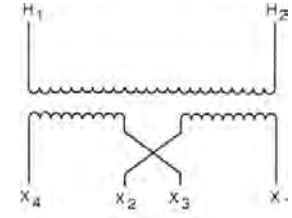

Diagram 5

General purpose encapsulated Single-phase NEMA 3R

Type QMS have an encapsulated core & coil fully encapsulated isolation transformer in a painted NEMA 3R non-ventilated enclosure with IP 20 wiring compartment



Type QMS, 5 kVA-25 kVA, Single-phase

5 - 25 kVA indoor/outdoor Type QMS 115°C Rise UL Listed C-UL Listed

Input voltage	Output voltage	kVA	Frequency (Hz)	Taps	Wiring diagram no. ¹	Weight (lbs)	Frame size	Ordering code
120 x 240 Volts	120/240 Volts	5	60	No Taps	1	103	16350	9T21B1001G02
		7.5	60	No Taps	1	147	16600	9T21B1002G02
		10	60	No Taps	1	198	19400	9T21B1003G02
		10	60	No Taps	1	198	19400	9T21B1054G02
		25	60	No Taps	1	233	19550	9T21B9102
208 Volts	120/240 Volts	5	60	No Taps	4	103	16350	9T21B1028G02
		7.5	60	No Taps	4	147	16600	9T21B1029G02
		10	60	No Taps	4	198	19400	9T21B1030G02
		15	60	No Taps	4	220	19500	9T21B9119
		25	60	No Taps	4	388	50500	9T21B9120

¹ See page 10B-25 for wiring diagrams.

² For Outdoor NEMA 3R Enclosure add suffix G62 to Catalog Number.

5 - 25 kVA indoor/outdoor Type QMS 115°C Rise UL Listed C-UL Listed

Input voltage	Output voltage	kVA	Frequency (Hz)	Taps	Wiring diagram no. ¹	Weight (lbs)	Frame size	Ordering code
277 Volts	120/240 Volts	5	60	(-2: 5.1%)	2	103	16350	9T21B1046G02
		7.5	60	(-2: 5.1%)	2	147	16600	9T21B1047G02
		10	60	(-2: 5.1%)	2	198	19400	9T21B1048G02
		10	60	(-2 2.5%)	2	198	19400	9T21B1266G02
		15	60	(-2: 5.1%)	2	220	19500	9T21B9143

¹ See page 10B-25 for wiring diagrams.

5 - 25 kVA indoor/outdoor Type QMS 115°C Rise UL Listed C-UL Listed

Input voltage	Output voltage	kVA	Frequency (Hz)	Taps	Wiring diagram no. ¹	Weight (lbs)	Frame size	Ordering code
240 x 480 Volts	120/240 Volts	5	60	No Taps	1	103	16350	9T21B1004G02
		5	50/60	No Taps	1	115	16400	9T21B1055G02
		7.5	60	No Taps	1	147	16600	9T21B1005G02
		7.5	50/60	No Taps	1	174	16600	9T21B1056G02
		10	60	No Taps	1	198	19400	9T21B1006G02
		10	50/60	No Taps	1	198	19400	9T21B1057G02
		15	60	No Taps	1	220	19500	9T21B9103
		15	50/60	No Taps	1	233	19550	9T21B9133
		25	60	No Taps	1	388	50500	9T21B9104
		25	50/60	No Taps	1	428	50600	9T21B9134
480 Volts	120/240 Volts	5	60	(-2: 5.0%)	2	103	16350	9T21B1007G02
		5	60	(+2, -2: 2.5%)	3	103	16350	9T21B1013G02
		7.5	60	(-2: 5.0%)	2	147	16600	9T21B1008G02
		7.5	60	(+2, -2: 2.5%)	3	147	16600	9T21B1014G02
		10	60	(-2: 4.9%)	2	198	19400	9T21B1009G02
		10	60	(+2, -2: 2.6%)	3	198	19400	9T21B1015G02
		15	60	(-2: 5.0%)	2	220	19500	9T21B9105
		15	60	(+2, -2: 2.5%)	3	220	19500	9T21B9109
		25	60	(-2: 5.0%)	2	388	50500	9T21B9106
25	60	(+2, -2: 2.5%)	3	388	50500	9T21B9110		
600 Volts	120/240 Volts	5	60	No Taps	5	103	16350	9T21B1016G02
		5	60	(-2: 5.0%)	2	103	16350	9T21B1019G02
		7.5	60	(-2: 5.0%)	2	147	16600	9T21B1020G02
		10	60	(-2: 4.9%)	2	198	19400	9T21B1021G02
		15	60	No Taps	5	220	19500	9T21B9111
		15	60	(-2: 4.8%)	2	220	19500	9T21B9113
25	60	(-2: 5.0%)	2	388	50500	9T21B9114		

¹ See page 10B-25 for wiring diagrams.

Dimensions and wiring diagrams

QMS transformers

Frame size	Outline drawing no.	Height (in.)	Width (in.)	Depth (in.)
16350	303B923AAP005	14.5	10.62	11
16400	303B923AAP005	14.5	10.62	11
16450	303B923AAP005	14.5	10.62 <td 11	
16600	303B923AAP007	17.06	10.62	11
19400	303B923AAP010	17.06	12.5	12.5
19450	303B923AAP010	17.06	12.5	12.5
19500	303B915AAP015	35	12.62	12.62
1619	303B922AAP001	14.50	10.75	11.12
1620	303B922AAP001	14.50	10.75	11.12
1921	303B922AAP003	17.12	12.62	12.75
1923	303B922AAP004	18.81	14.75	14.53
50500	303B915AAP025	44.75	16.75	16

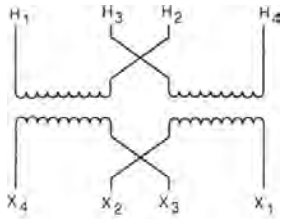

Diagram 1

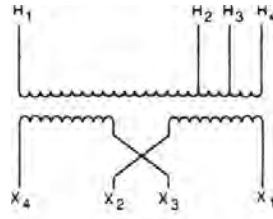

Diagram 2

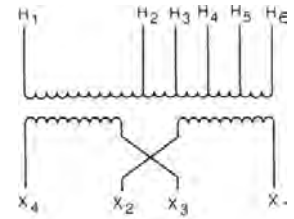

Diagram 3

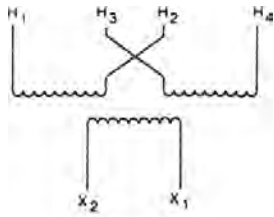

Diagram 4

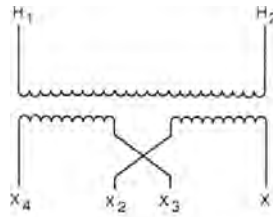

Diagram 5

