

# IEC Product Catalog North America





01

02

03

# Table of contents

<b>Modular Enclosures</b> .....	<b>8</b>
Single Door   MCS.....	10
Single Door, High Protection   MCS-HP.....	16
Single Door, Type 3R   MCS-3R .....	20
Double Door   MCD.....	24
Flange Mount Disconnect   MCF.....	28
Modular - Accessories.....	32
<b>Wall Mounted Enclosures</b> .....	<b>96</b>
Single Door   MAS.....	98
Double Door   MAD.....	104
Single Door   ASR.....	108
Wall Mounted - Accessories.....	112
<b>Terminal Boxes</b> .....	<b>132</b>
Mild Steel Terminal Box   STB.....	132
Stainless Steel Terminal Box   SSTB.....	134
Terminal Boxes - Accessories.....	136

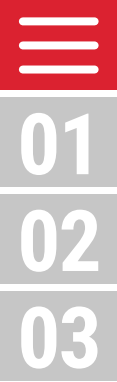



01

02

03

**01** FAST  
ASSEMBLY

**02** OPTIMUM  
PROTECTION

**03**



nVent HOFFMAN IEC-rated Enclosures and Accessories offer versatile solutions in mild steel and stainless steel and are available as modular, wall mounted, or terminal box options to suit your application needs. Interchangeable accessories and tool-free assembly simplify the specification and installation processes. Single global part numbers make ordering streamlined and easy.

# 03 APPEALING DESIGN



01

02

03



The IEC Modular Selection Tool provides a guided experience to quickly and easily create standard IEC modular product configurations. This powerful tool allows you to quickly generate precise, error-free BOMs, ensuring that each component is accounted for. The selection tool also includes intelligent features for accessories, such as detecting conflicting choices and automatically adding required sub-accessories.



**Create your error-free BOM using the online IEC Modular Selection Tool!**



**MODULAR ENCLOSURES**

	Single Door	Single Door, High Protection	Single Door, Type 3R	Double Door	Flange Mount Disconnect
Enclosure Ratings	IP 55	IP 66	IP 55	IP 55	IP 55
	TYPE 12	TYPE 4, 12	TYPE 3R	TYPE 12	TYPE 12
	IK 10	IK 10	IK 10	IK 10	IK 10
Enclosure Dimensions	H: 1400 - 2200	H: 2000	H: 2000 - 2200	H: 1400 - 2200	H: 1400 - 2200
	W: 400 - 1000	W: 800	W: 600 - 1000	W: 800 - 1600	W: 800 - 1600
	D: 400 - 800	D: 600	D: 600 - 800	D: 400 - 800	D: 400 - 800

All measurements in mm.

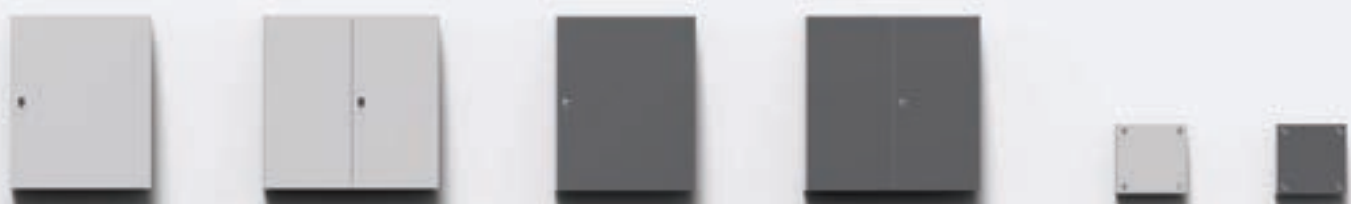

**WALL MOUNTED ENCLOSURES**

	Single Door	Double Door
Enclosure Ratings	IP 66	IP 55
	TYPE 4, 12	TYPE 12
	IK 10	IK 10
Enclosure Dimensions	H: 200 - 1200	H: 600 - 1200
	W: 200 - 800	W: 800 - 1200
	D: 155 - 400	D: 210 - 400

All measurements in mm.

**TERMINAL BOXES**

	Box - Plain Cover
Enclosure Ratings	IP 66
	Type 4, 12
	IK 08
Enclosure Dimensions	H: 150 - 400
	W: 150 - 800
	D: 80 - 120

All measurements in mm.



## Modular Enclosures

01

Modular Enclosures



**14 MINUTES  
SAVED**

for each two bayed enclosures  
using the below accessories

**10** x BAYING BRACKETS

**2** x SIDE PANELS

**2** x MOUNTING PLATES

**1** x FILLER PLATE

**+** x PROFILES



### FAST ASSEMBLY



Click-in  
baying brackets



Click-in  
mounting profiles



Click-in  
filler plate



Mounting plate  
fixation bracket



Click-in  
side panel



Side panel  
hanging



**OPTIMUM PROTECTION**

**APPEALING DESIGN**



**Two pins hinge**



**Locking system**

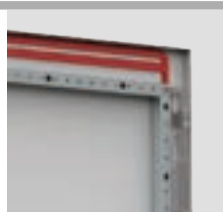

**Low water absorption gasket**

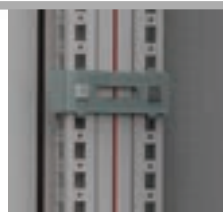

**IP 66 baying kit**



**Lock covers and lifting handles**



**Modular  
Mild Steel**  
Single door | MCS

**01**

IP 55 | TYPE 12 | IK 10

Modular Enclosures

**02**

**03**





**Material:**

Frame: 1.5 mm painted steel. Door: 2 mm painted steel. Rear, roof and side panels: 1.5 mm painted steel. Mounting plate: 3 mm galvanized steel. Bottom plates: 1 mm galvanized steel.

**Frame:**

Seam welded reversed open profiles with 25 mm hole pattern, according to DIN 43660. Including integrated external hole pattern.

**Door:**

Mounted with four hinges allowing left or right hand opening. Including door frame with 25 mm hole pattern.

**Rear panel:**

Fitted by M6 torx screws. Standard facilities for rear door mounting.

**Side panels:**

Supplied as an accessory.

**Roof panel:**

Removable.

**Lock:**

4-point espagnolette locking system. Does not interfere with the enclosure inner space. Standard double-bit lock with 3 mm insert. Standard inserts, cylinders, lift handles and T-handles are available as accessories.

**Bottom plates:**

Consists of three or four (D>600) pieces.

**Mounting plate:**

Double folded and slides into position. Adjustable in depth by steps of 25 mm, with the MPD02 accessory. Supplied, attached on the outside of the enclosure packaging.

**Earthing:**

All panels are earthed through their fittings and are equipped with a separate earthing stud.

**Finish:**

RAL 7035 structured powder coating.

**Protection:**

Complies with IP 55 | TYPE 12 | IK 10.

**Mounting requirements:**

Standard delivery ready for combined installation. For stand-alone installation add side panels.

**Delivery:**

Frame with fitted door, rear panel, roof panel, bottom plates, mounting plate (not included for PER5 version) and door frame. For 400 mm wide enclosures, a mounting plate, bottom plates and door frame are not included. For enclosures 2200 mm height, delivery includes two CMB profiles mounted in depth. Delivery also includes earthing bolts. Delivered on a pallet which is identical to the width of the enclosure to allow buying without removal.



# Dimensional table | MCS



01

Modular Enclosures

02

03

## IP 55 | TYPE 12 | IK 10

Cable enclosures: without mounting plate, bottom plates and door frame

Catalog no.	Enclosure dimensions		
	H	W	D
MCS18044R5	1800	400	400
MCS18045R5	1800	400	500
MCS18046R5	1800	400	600
MCS20044R5	2000	400	400
MCS20045R5	2000	400	500
MCS20046R5	2000	400	600
MCS20048R5	2000	400	800

All measurements in mm.

With mounting plate

Catalog no.	Enclosure dimensions			Mounting plate dimensions		Usable depth
	H	W	D	h	w	d
MCS14065R5	1400	600	500	1294	494	459
MCS14085R5	1400	800	500	1294	694	459
MCS16065R5	1600	600	500	1494	494	459
MCS16085R5	1600	800	500	1494	694	459
MCS18055R5	1800	500	500	1694	394	459
MCS18064R5	1800	600	400	1694	494	359
MCS18065R5	1800	600	500	1694	494	459
MCS18066R5	1800	600	600	1694	494	559
MCS18068R5	1800	600	800	1694	494	759
MCS18084R5	1800	800	400	1694	694	359
MCS18085R5	1800	800	500	1694	694	459
MCS18086R5	1800	800	600	1694	694	559
MCS18088R5	1800	800	800	1694	694	759
MCS18104R5	1800	1000	400	1694	894	359
MCS18105R5	1800	1000	500	1694	894	459
MCS18106R5	1800	1000	600	1694	894	559
MCS18108R5	1800	1000	800	1694	894	759
MCS20055R5	2000	500	500	1894	394	459
MCS20064R5	2000	600	400	1894	494	359
MCS20065R5	2000	600	500	1894	494	459
MCS20066R5	2000	600	600	1894	494	559
MCS20068R5	2000	600	800	1894	494	759
MCS20084R5	2000	800	400	1894	694	359
MCS20085R5	2000	800	500	1894	694	459
MCS20086R5	2000	800	600	1894	694	559
MCS20088R5	2000	800	800	1894	694	759
MCS20104R5	2000	1000	400	1894	894	359
MCS20105R5	2000	1000	500	1894	894	459
MCS20106R5	2000	1000	600	1894	894	559
MCS20108R5	2000	1000	800	1894	894	759
MCS22066R5	2200	600	600	2094	494	559
MCS22068R5	2200	600	800	2094	494	759
MCS22086R5	2200	800	600	2094	694	559
MCS22088R5	2200	800	800	2094	694	759
MCS22106R5	2200	1000	600	2094	894	559
MCS22108R5	2200	1000	800	2094	894	759
MCS22105R5	2200	1000	500	2094	894	459
MCS22065R5	2200	600	500	2094	494	459
MCS22085R5	2200	800	500	2094	694	459
MCS200810R5	2000	800	1000	1894	694	959
MCS220810R5	2200	800	1000	2094	694	959

All measurements in mm.

# Dimensional table | MCS

01

Modular Enclosures

02

03

Without mounting plate

Catalog no.	Enclosure dimensions			Mounting plate dimensions		Usable depth
	H	W	D	h	w	d
MCS14065PER5	1400	600	500	1294	494	459
MCS16065PER5	1600	600	500	1494	494	459
MCS16085PER5	1600	800	500	1494	694	459
MCS18055PER5	1800	500	500	1694	394	459
MCS18064PER5	1800	600	400	1694	494	359
MCS18065PER5	1800	600	500	1694	494	459
MCS18066PER5	1800	600	600	1694	494	559
MCS18084PER5	1800	800	400	1694	694	359
MCS18085PER5	1800	800	500	1694	694	459
MCS18086PER5	1800	800	600	1694	694	559
MCS18088PER5	1800	800	800	1694	694	759
MCS18104PER5	1800	1000	400	1694	894	359
MCS18105PER5	1800	1000	500	1694	894	459
MCS18106PER5	1800	1000	600	1694	894	559
MCS18108PER5	1800	1000	800	1694	894	759
MCS20064PER5	2000	600	400	1894	494	359
MCS20065PER5	2000	600	500	1894	494	459
MCS20066PER5	2000	600	600	1894	494	559
MCS20068PER5	2000	600	800	1894	494	759
MCS20084PER5	2000	800	400	1894	694	359
MCS20085PER5	2000	800	500	1894	694	459
MCS20086PER5	2000	800	600	1894	694	559
MCS20088PER5	2000	800	800	1894	694	759
MCS20104PER5	2000	1000	400	1894	894	359
MCS20105PER5	2000	1000	500	1894	894	459
MCS20106PER5	2000	1000	600	1894	894	559
MCS20108PER5	2000	1000	800	1894	894	759
MCS200810PER5	2000	800	1000	1894	694	959
MCS22066PER5	2200	600	600	2094	494	559
MCS22068PER5	2200	600	800	2094	494	759
MCS22086PER5	2200	800	600	2094	694	559
MCS22088PER5	2200	800	800	2094	694	759
MCS22106PER5	2200	1000	600	2094	894	559
MCS22108PER5	2200	1000	800	2094	894	759
MCS22105PER5	2200	1000	500	2094	894	459
MCS22065PER5	2200	600	500	2094	494	459
MCS22085PER5	2200	800	500	2094	694	459
MCS220810PER5	2200	800	1000	2094	694	959

All measurements in mm.

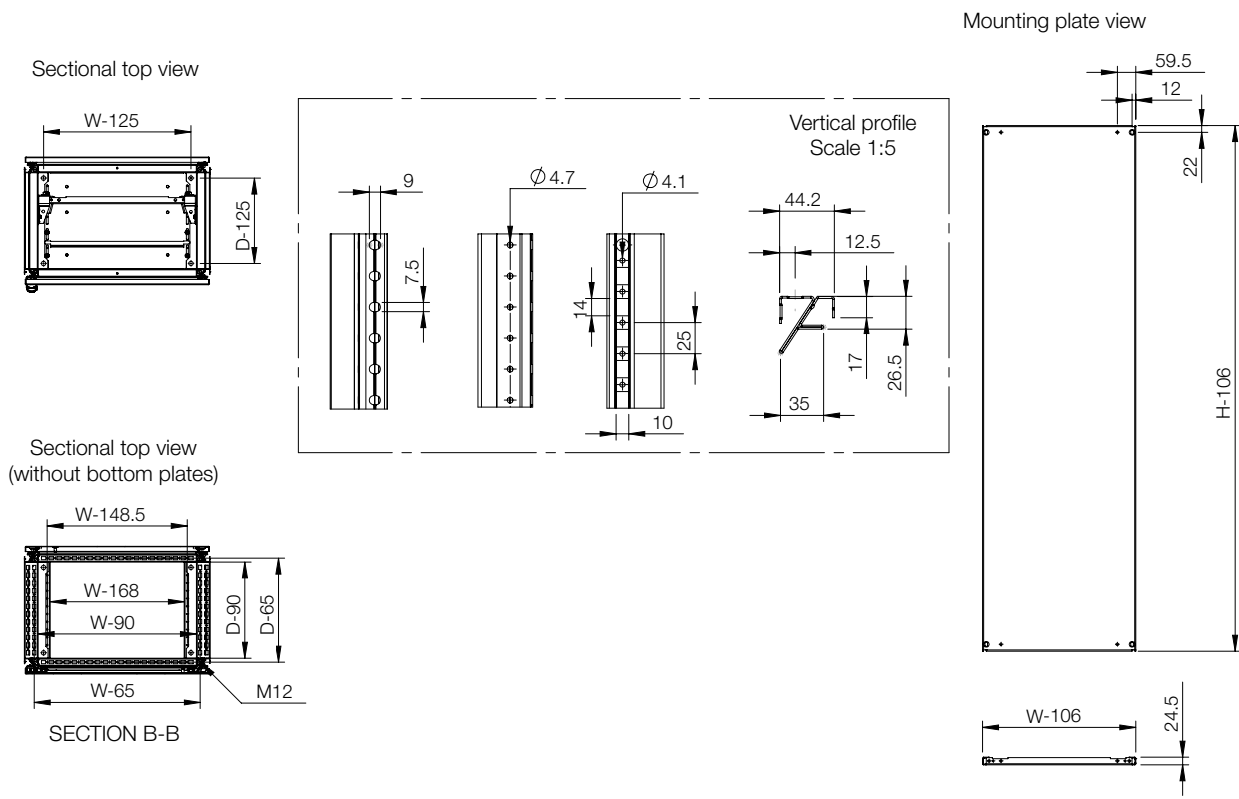
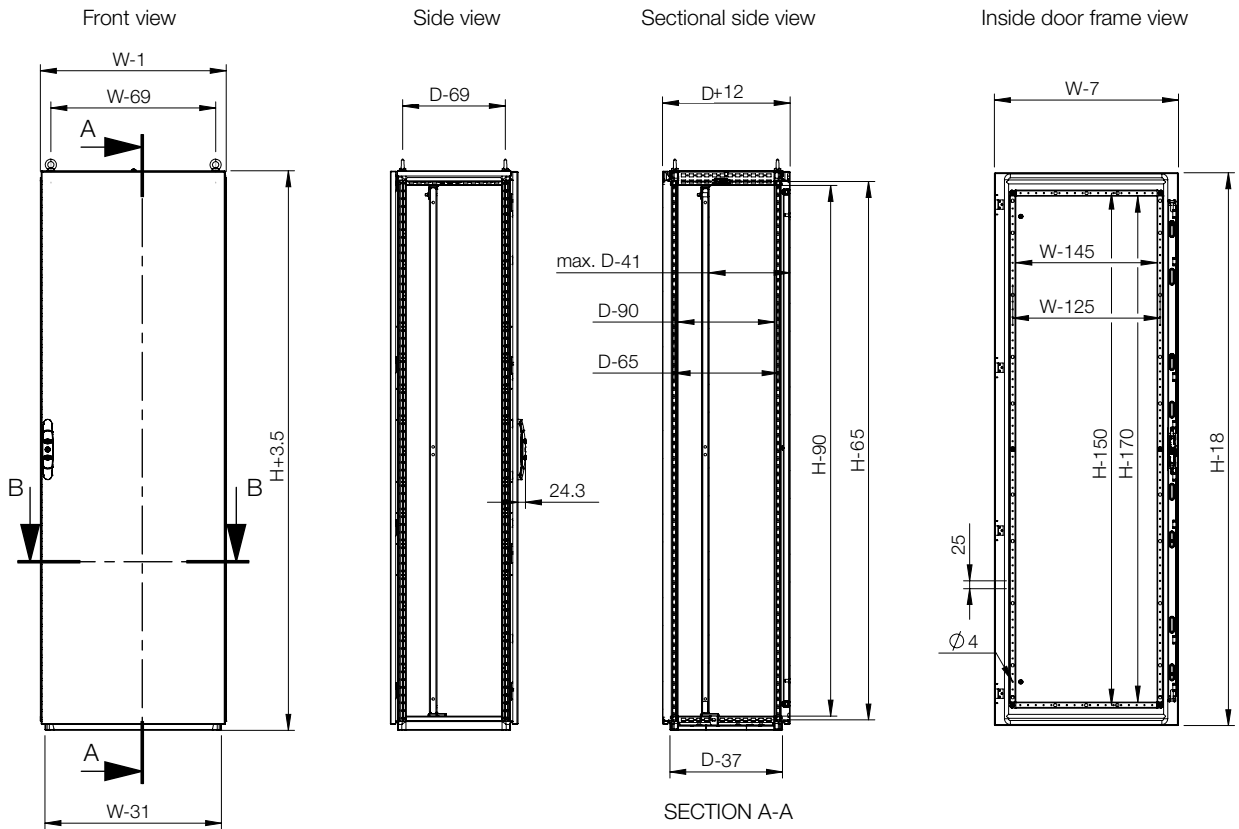



# Modular Mild Steel

01

Single door, high protection | MCS-HP

Modular Enclosures

IP 66 | TYPE 4, 12 | IK 10

02

03



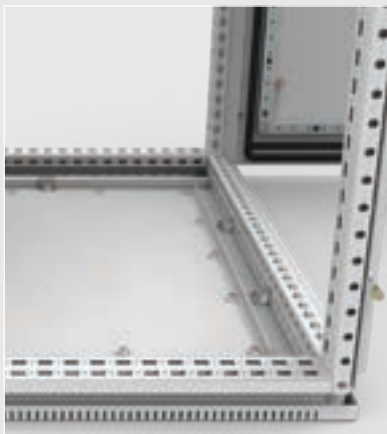

**Material:**

Frame: 1.5 mm painted steel. Door: 2 mm painted steel. Rear, roof and side panels: 1.5 mm painted steel. Mounting plate: 3 mm galvanized steel. Bottom plates: 1 mm galvanized steel.

**Frame:**

Seam welded reversed open profiles with 25 mm hole pattern according to DIN 43660. Including integrated external hole pattern.

**Door:**

Mounted with four hinges allowing left or right hand opening. Including door frame with 25 mm hole pattern.

**Rear panel:**

Fitted by M6 torx screws. Standard facilities for rear door mounting.

**Side panels:**

Supplied as an accessory.

**Roof panel:**

Removable.

**Lock:**

4-point espagnolette locking system. Does not interfere with the enclosure inner space. Standard double-bit lock with 3 mm insert. Standard inserts, cylinders, lift handles and T-handles are available as accessories.

**Bottom plates:**

One piece bottom plate, with injected polyurethane gasket to ensure maximum sealing.

**Mounting plate:**

Double folded and slides into position. Adjustable in depth by steps of 25 mm, with the MPD02 accessory. Supplied, attached on the outside of the enclosure packaging.

**Earthing:**

All panels are earthed through their fittings and are equipped with a separate earthing stud.

**Finish:**

RAL 7035 structured powder coating.

**Protection:**

Complies with IP 66 | TYPE 4, 12 | IK 10.

**Mounting requirements:**

Standard delivery ready for combined installation. For stand-alone installation add side panels.

**Delivery:**

Frame with fitted door, rear panel, roof panel, bottom plate, mounting plate and door frame. Delivery also includes earthing bolts. Delivered on a pallet which is identical to the width of the enclosure to allow baying without removal.



# Dimensional table | MCS-HP



01

Modular Enclosures

## IP 66 | TYPE 4, 12 | IK 10

Catalog no.	Enclosure dimensions			Mounting plate dimensions		Usable depth
	H	W	D	h	w	d
MCS20086HP	2000	800	600	1894	694	559
MCS20066HP	2000	600	600	1894	494	559
MCS18086HP	1800	800	600	1694	694	559

*\*Other dimensions available on request. Special side panel is required if depth is greater than 700 mm.*

All measurements in mm.

02

03

# Dimensional drawing | MCS-HP



01

Modular Enclosures

02

03

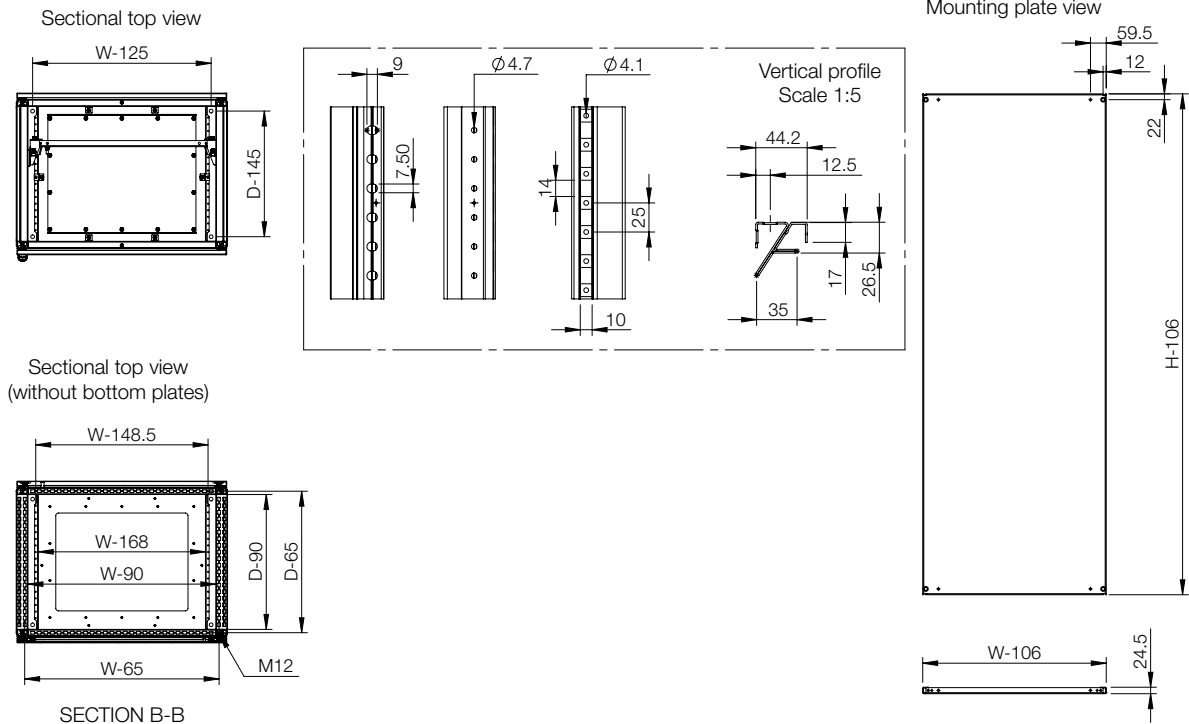
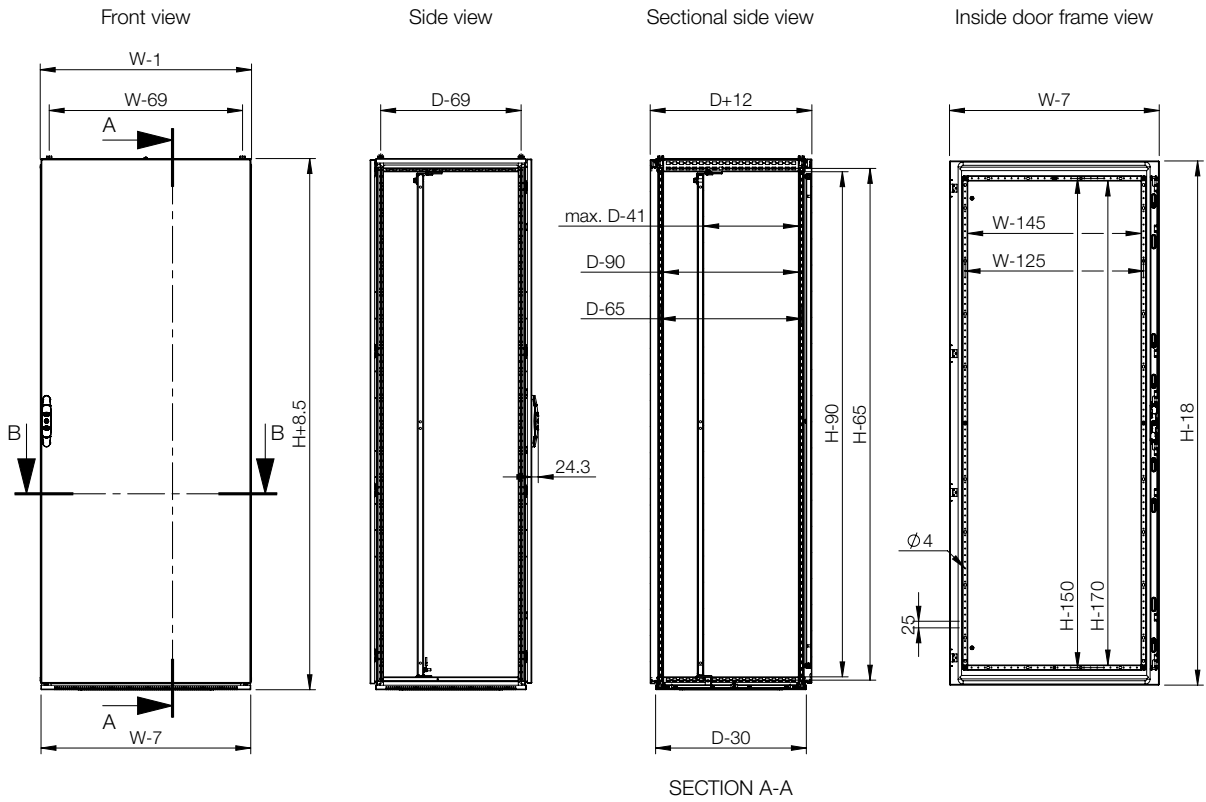



# Modular Mild Steel

01

Single door, Type 3R | MCS-3R

Modular Enclosures

IP 55 | TYPE 3R | IK 10

02

03



**Material:**

Frame: 1.5 mm painted steel. Door: 2 mm painted steel. Rear, roof and side panels: 1.5 mm painted steel. Mounting plate: 3 mm galvanized steel. Bottom plates: 1 mm galvanized steel.

**Frame:**

Seam welded reversed open profiles with 25 mm hole pattern, according to DIN 43660. Including integrated external hole pattern.

**Door:**

Mounted with four hinges allowing left or right hand opening. Including door frame with 25 mm hole pattern.

**Rear panel:**

Fitted by M6 torx screws. Standard facilities for rear door mounting.

**Side panels:**

Supplied as an accessory.

**Roof panel:**

Removable.

**Lock:**

Espagnolette 4-point locking system. Does not interfere with the enclosure inner space. Standard double-bit lock with 3 mm insert. Standard inserts, cylinders, lift handles and T-handles are available as accessories.

**Bottom plates:**

Consists of three or four (D>600) pieces.

**Mounting plate:**

Double folded and slides into position. Adjustable in depth by steps of 25 mm, with the MPD02 accessory. Supplied, attached on the outside of the enclosure packaging.

**Earthing:**

All panels are earthed through their fittings and are equipped with a separate earthing stud.

**Finish:**

RAL 7035 structured powder coating.

**Protection:**

Complies with IP 55 | TYPE 3R | IK 10.

**Mounting requirements:**

Standard delivery ready for combined installation. For stand-alone installation add side panels.

**Delivery:**

Frame with fitted door, rear panel, roof panel, bottom plates and door frame. For enclosures 2200 mm height, delivery includes two CMB profiles mounted in depth. Delivery also includes earthing bolts.



# Dimensional table | MCS-3R



01

Modular Enclosures

IP 55 | TYPE 3R | IK 10

Catalog no.	Enclosure dimensions			Mounting plate dimensions		Usable depth
	H	W	D	h	w	d
MCS20066R53R	2000	600	600	1894	494	559
MCS20086R53R	2000	800	600	1894	694	559
MCS20106R53R	2000	1000	600	1894	894	559
MCS20108R53R	2000	1000	800	1894	894	759
MCS20068R53R	2000	600	800	1894	494	759
MCS20088R53R	2000	800	800	1894	694	759
MCS22106R53R	2200	1000	600	2094	894	559
MCS22108R53R	2200	1000	800	2094	894	759
MCS22068R53R	2200	600	800	2094	494	759
MCS22086R53R	2200	800	600	2094	694	559
MCS22088R53R	2200	800	800	2094	694	759

All measurements in mm.

02

03

# Dimensional drawing | MCS-3R



01

Modular Enclosures

02

03

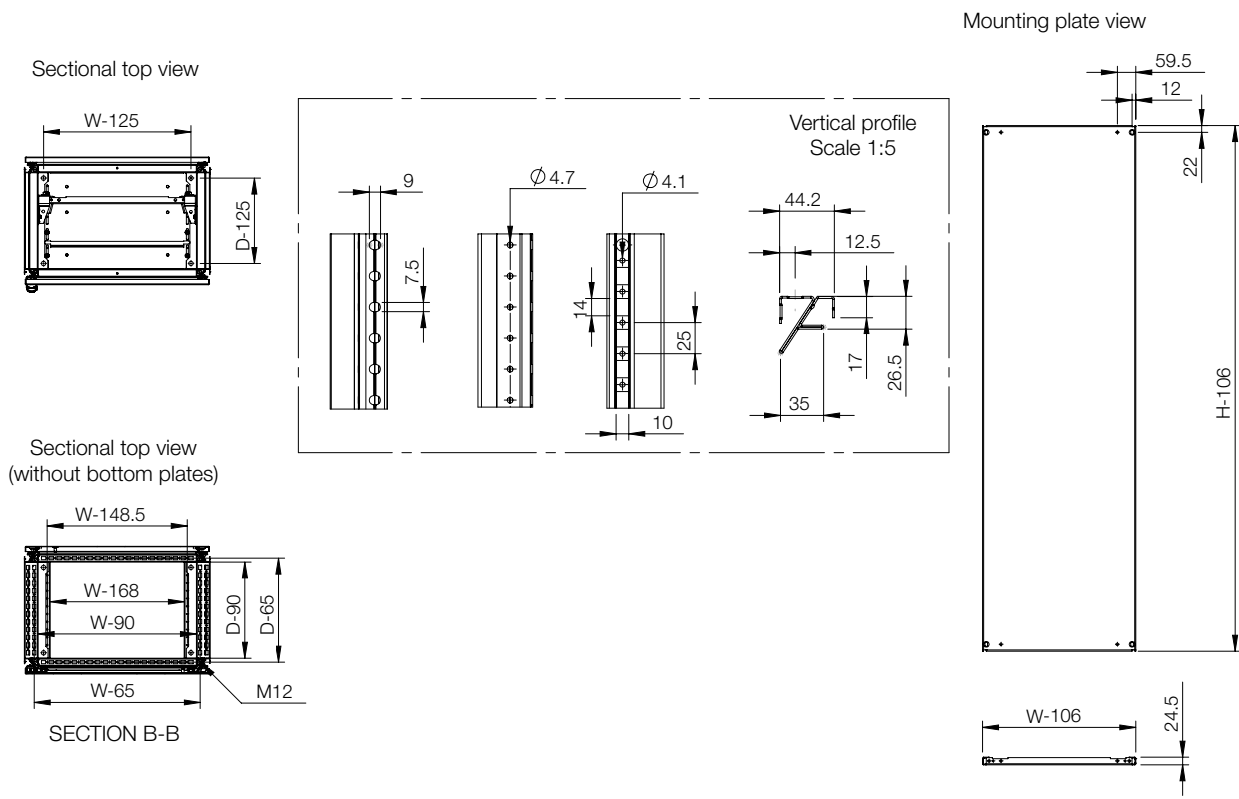
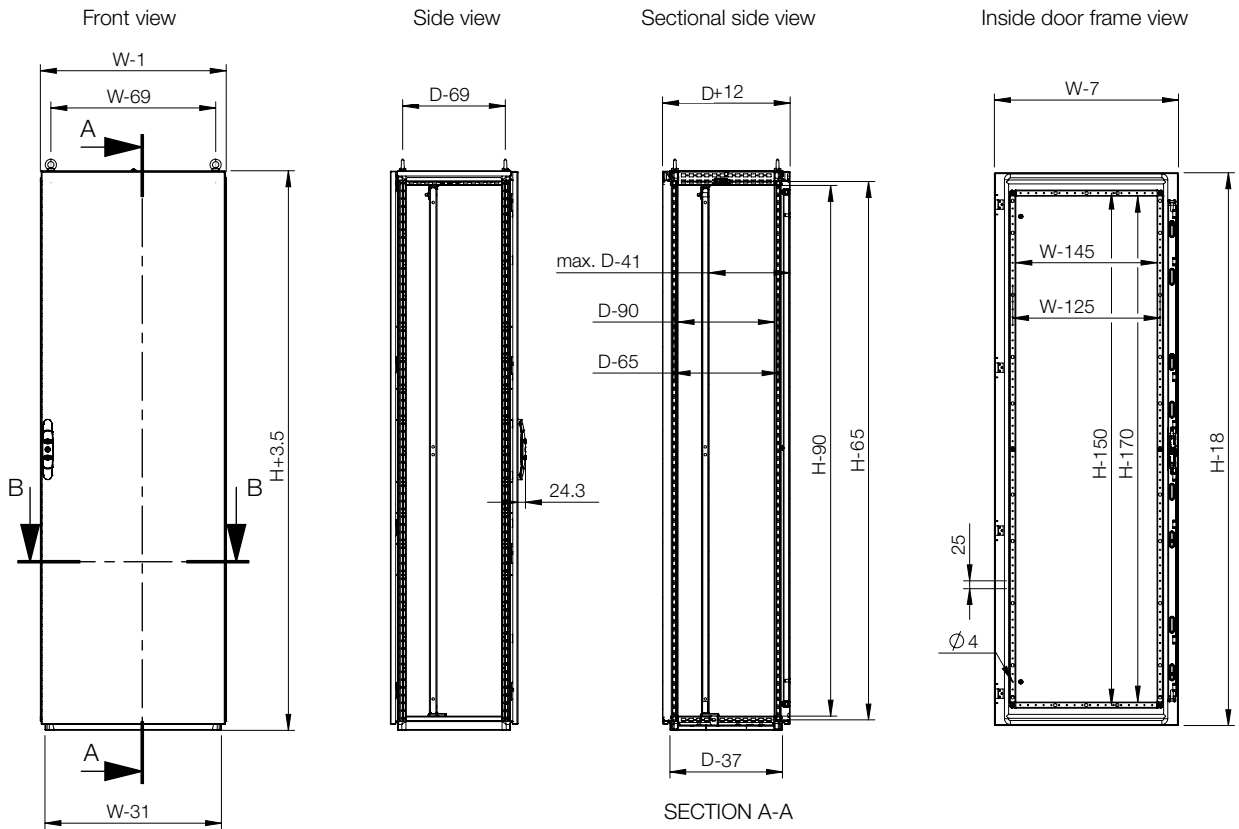



**Modular  
Mild Steel**  
Double door | MCD



IP 55 | TYPE 12 | IK 10





**Material:**

Frame: 1.5 mm painted steel. Doors: 2 mm painted steel. Rear, roof and side panels: 1.5 mm painted steel. Mounting plate: 3 mm galvanized steel. Bottom plates: 1 mm galvanized steel.

**Frame:**

Seam welded reversed open profiles with 25 mm hole pattern, according to DIN 43660. Including integrated external hole pattern.

**Doors:**

Mounted with four hinges. Including door frame with 25 mm hole pattern. Doors cannot be reversed. Separate doors to be ordered for left hand door locking.

**Rear panel:**

Fitted by M6 torx screws. Standard facilities for rear doors mounting. Split rear panels in 1600 mm wide enclosures.

**Side panels:**

Supplied as an accessory.

**Roof panel:**

Removable.

**Lock:**

4-point espagnolette locking system in the main door and 2-point espagnolette locking system in the secondary door. Standard double-bit lock with 3 mm insert. Standard inserts, cylinders, lift handles and T-handles are available as accessories.

**Bottom plates:**

Consists of three or four (D>600) pieces.

**Mounting plate:**

Double folded and slides into position. Adjustable in depth by steps of 25 mm, with the MPD02 accessory. Supplied, attached on the outside of the enclosure packaging.

**Earthing:**

All panels are earthed through their fittings and equipped with a separate earthing stud.

**Finish:**

RAL 7035 structured powder coating.

**Protection:**

Complies with IP55 | TYPE 12 | IK 10.

**Mounting requirements:**

Standard delivery ready for combined installation. For stand-alone installation add side panels.

**Delivery:**

Frame with fitted doors, rear panel, roof panel, bottom plates, mounting plate and door frame (not included for PER5 version). For enclosures 2200 mm height, delivery includes two CMB profiles mounted in depth. Delivery also includes earthing bolts. Delivered on a pallet which is identical to the width of the enclosure to allow buying without removal.



# Dimensional table | MCD

01

Modular Enclosures

02

03

## IP 55 | TYPE 12 | IK 10

With mounting plate

Catalog no.	Enclosure dimensions			Mounting plate dimensions		Usable depth
	H	W	D	h	w	
MCD12125R5	1200	1200	500	1094	1094	459
MCD14125R5	1400	1200	500	1294	1094	459
MCD16125R5	1600	1200	500	1494	1094	459
MCD18085R5	1800	800	500	1694	694	459
MCD18104R5	1800	1000	400	1694	894	359
MCD18105R5	1800	1000	500	1694	894	459
MCD18124R5	1800	1200	400	1694	1094	359
MCD18125R5	1800	1200	500	1694	1094	459
MCD18126R5	1800	1200	600	1694	1094	559
MCD18164R5	1800	1600	400	1694	1494	359
MCD18165R5	1800	1600	500	1694	1494	459
MCD18166R5	1800	1600	600	1694	1494	559
MCD18185R5	1800	1800	500	1694	1694	459
MCD18186R5	1800	1800	800	1694	1694	759
MCD20085R5	2000	800	500	1894	694	459
MCD20086R5	2000	800	600	1894	694	559
MCD20088R5	2000	800	800	1894	694	694
MCD20104R5	2000	1000	400	1894	894	359
MCD20105R5	2000	1000	500	1894	894	459
MCD20106R5	2000	1000	600	1894	894	559
MCD20108R5	2000	1000	800	1894	894	759
MCD20124R5	2000	1200	400	1894	1094	359
MCD20126R5	2000	1200	600	1894	1094	559
MCD20125R5	2000	1200	500	1894	1094	459
MCD20128R5	2000	1200	800	1894	1094	759
MCD20164R5	2000	1600	400	1894	1494	359
MCD20165R5	2000	1600	500	1894	1494	459
MCD20166R5	2000	1600	600	1894	1494	559
MCD20168R5	2000	1600	800	1894	1494	759
MCD200810R5	2000	800	1000	1894	694	959
MCD20185R5	2000	1800	500	1894	1694	459
MCD20186R5	2000	1800	600	1894	1694	559
MCD20188R5	2000	1800	800	1894	1694	759
MCD22106R5	2200	1000	600	2094	894	559
MCD22125R5	2200	1200	500	2094	1094	459
MCD22126R5	2200	1200	600	2094	1094	559
MCD22128R5	2200	1200	800	2094	1094	759
MCD22166R5	2200	1600	600	2094	1494	559
MCD220810R5	2200	800	1000	2094	694	959

All measurements in mm.

Without mounting plate

Catalog no.	Enclosure dimensions			Mounting plate dimensions		Usable depth
	H	W	D	h	w	
MCD12125PER5	1200	1200	500	1094	1094	459
MCD14125PER5	1400	1200	500	1294	1094	459
MCD16125PER5	1600	1200	500	1494	1094	459
MCD18085PER5	1800	800	500	1694	694	459
MCD18104PER5	1800	1000	400	1694	894	359
MCD18105PER5	1800	1000	500	1694	894	459
MCD18124PER5	1800	1200	400	1694	1094	359
MCD18125PER5	1800	1200	500	1694	1094	459
MCD18126PER5	1800	1200	600	1694	1094	559
MCD18164PER5	1800	1600	400	1694	1494	359
MCD18166PER5	1800	1600	600	1694	1494	559
MCD18185PER5	1800	1800	500	1694	1694	459
MCD18186PER5	1800	1800	800	1694	1694	759
MCD20104PER5	2000	1000	400	1894	894	359
MCD20105PER5	2000	1000	500	1894	894	459
MCD20106PER5	2000	1000	600	1894	894	559
MCD20108PER5	2000	1000	800	1894	894	759
MCD20124PER5	2000	1200	400	1894	1094	359
MCD20125PER5	2000	1200	500	1894	1094	459
MCD20126PER5	2000	1200	600	1894	1094	559
MCD20128PER5	2000	1200	800	1894	1094	759
MCD20164PER5	2000	1600	400	1894	1494	359
MCD20165PER5	2000	1600	500	1894	1494	459
MCD20166PER5	2000	1600	600	1894	1494	559
MCD20168PER5	2000	1600	800	1894	1494	759
MCD200810PER5	2000	800	1000	1894	694	959
MCD20185PER5	2000	1800	500	1894	1694	459
MCD20186PER5	2000	1800	600	1894	1694	559
MCD20188PER5	2000	1800	800	1894	1694	759
MCD22106PER5	2200	1000	600	2094	894	559
MCD22126PER5	2200	1200	600	2094	1094	559
MCD220810PER5	2200	800	1000	2094	694	959

All measurements in mm.

# Dimensional drawing | MCD



01

Modular Enclosures

02

03

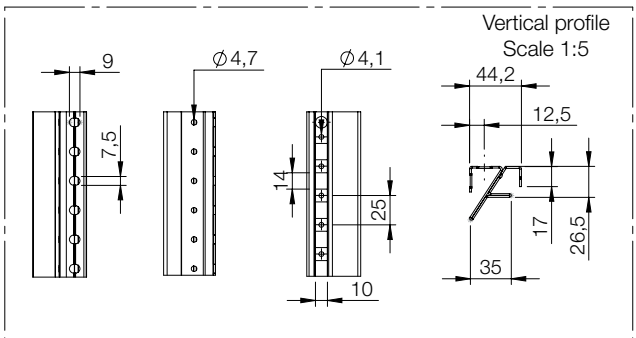
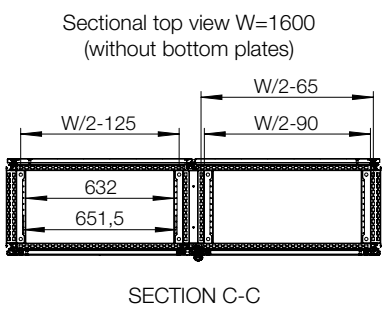
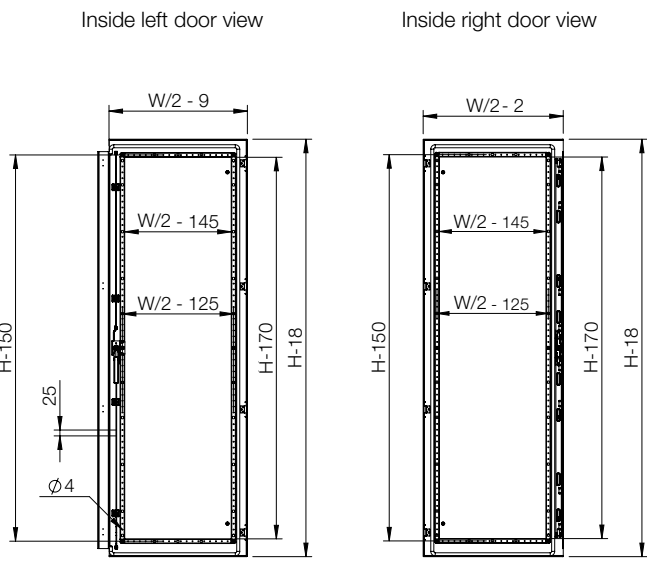
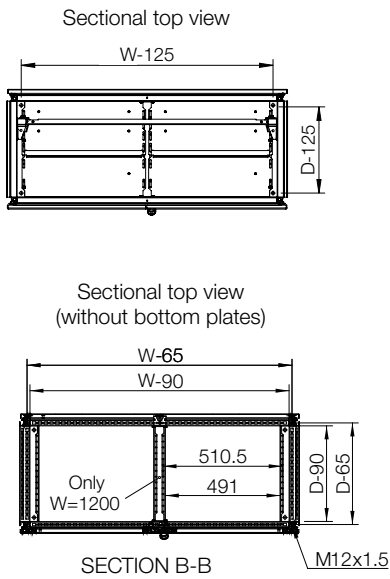
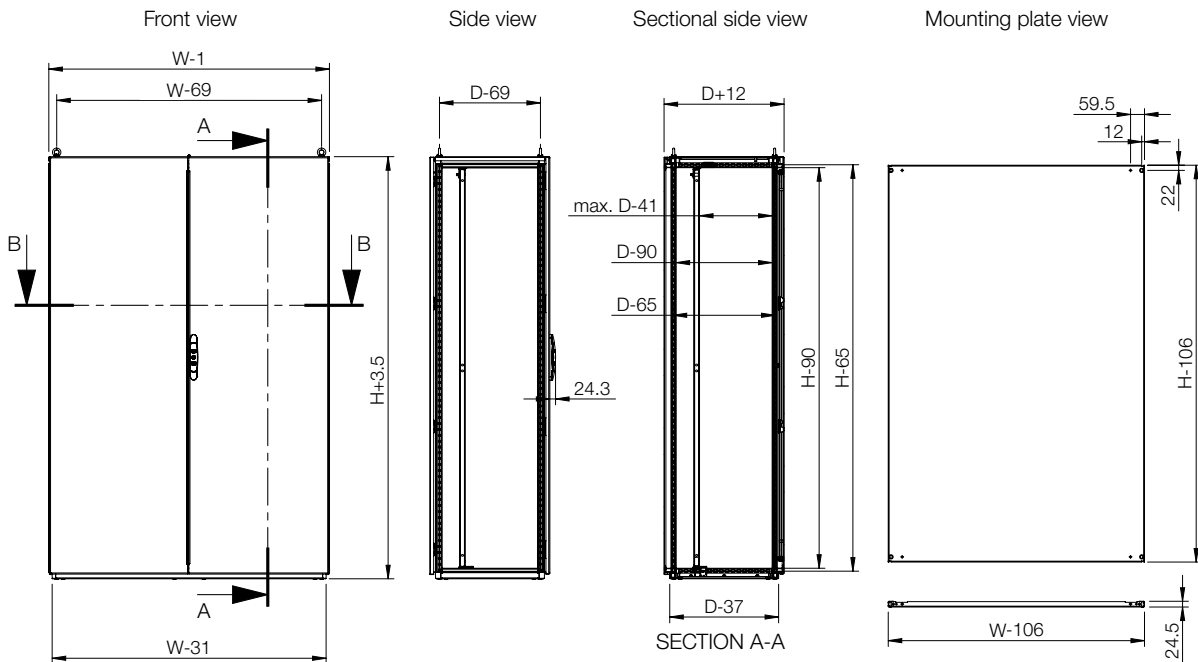



# Modular Mild Steel

01

## Flange Mount Disconnect | MCF

IP 55 | TYPE 12 | IK 10

Modular Enclosures

02

03



**Material:**

Frame: 1.5 mm painted steel. Doors: 2 mm painted steel. Rear, roof and side panels: 1.5 mm painted steel. Mounting plate: 3 mm galvanized steel. Bottom plates: 1 mm galvanized steel.

**Frame:**

Seam welded reversed open profiles with 25 mm hole pattern, according to DIN 43660. Including integrated external hole pattern.

**Door:**

Mounted with four hinges. Including door frame with 25 mm hole pattern. Door can not be reversed. Flange door: Surface mounted with hinges, locked from the inside, including universal cut-out.

**Rear panel:**

Fitted by M6 torx screws. Standard facilities for rear door mounting.

**Side panels:**

Supplied as an accessory.

**Roof panel:**

Removable.

**Lock:**

Lock, main door: 4-point espagnolette locking system. Does not interfere with the enclosure inner space. Standard double-bit lock with 3 mm insert. Standard inserts, cylinders, lift handles and T-handles are available as accessories. Lock, secondary door: Top and bottom lock with double-bit for easy opening of the door. Double-bit 3 mm insert and 90° movement. Other inserts are available as an accessory.

**Bottom plates:**

Consists of three pieces.

**Mounting plate:**

Double folded and adjustable in depth by steps of 25 mm, with the MPD02 accessory. Supplied, attached on the outside of the enclosure packaging.

**Earthing:**

All panels are earthed through their fittings and are equipped with a separate earthing stud.

**Finish:**

RAL 7035 structured powder coating.

**Protection:**

Complies with IP 55 | TYPE 12 | IK 10.

**Mounting requirements:**

Standard delivery ready for combined installation. Sides of the group of combined enclosures must be closed with side panels SPM. To complete the intelocking system add FMD in this main enclosure and FMA, FMB, FMS in the secondary enclosures.

**Delivery:**

Frame with fitted doors, rear panel, roof panel, bottom plates, mounting plate and door frame. Delivery also includes earthing bolts. Delivered on a pallet which is identical to the width of the enclosure to allow baying without removal.



# Dimensional table | MCF



01

Modular Enclosures

02

03

## IP 55 | TYPE 12 | IK 10

Catalog no.	Enclosure dimensions			Mounting plate dimension		Usable depth
	H	W	D	h	w	d
MCF14085R5	1400	800	500	1294	800	459
MCF14105R5	1400	1000	500	1294	1000	459
MCF14165R5	1400	1600	500	1294	1600	459
MCF18084R5	1800	800	400	1694	800	359
MCF18085R5	1800	800	500	1694	800	459
MCF18105R5	1800	1000	500	1694	1000	459
MCF18165R5	1800	1600	500	1694	1600	459
MCF18185R5	1800	1800	500	1694	1694	459
MCF18186R5	1800	1800	600	1694	1694	559
MCF20085R5	2000	800	500	1894	800	459
MCF20086R5	2000	800	600	1894	800	559
MCF20088R5	2000	800	800	1894	800	759
MCF20105R5	2000	1000	500	1894	1000	459
MCF20106R5	2000	1000	600	1894	1000	559
MCF20165R5	2000	1600	500	1894	1600	459
MCF20166R5	2000	1600	600	1894	1600	559
MCF20185R5	2000	1800	500	1894	1694	459
MCF20186R5	2000	1800	600	1894	1694	559
MCF22086R5	2200	800	600	2094	800	559
MCF22105R5	2200	1000	500	2094	1000	459
MCF22106R5	2200	1000	600	2094	894	559

All measurements in mm.

# Dimensional drawing | MCF



01

Modular Enclosures

02

03

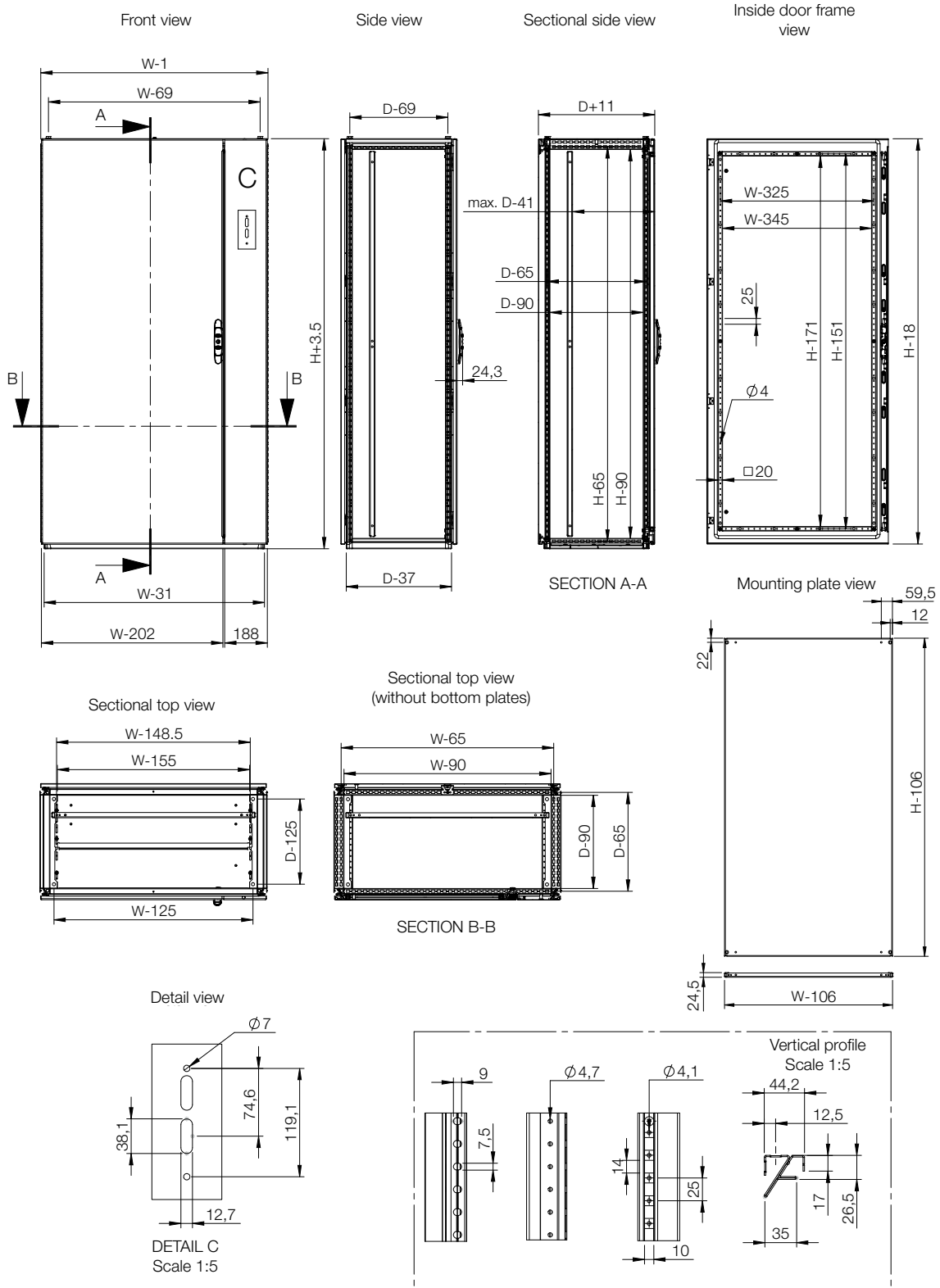

# Modular

## Accessories

### Mounting plates, MP

**Description:** Standard mounting plate. It can also be mounted on the side of an enclosure by using MPS kit or slid in from the side with the MTS profile. For heavy loads in vibrating environments use mounting plate reinforcement profile MPR and MPE or MPEF brackets.

**Material:** 3 mm galvanized steel.

**Pack quantity:** 1 piece.

**Maximum load:** 6000 N.

**Mounting requirements:** Use MPA for mounting the MP inside the enclosure. Adjustable in depth with MPD accessory.



Catalog no.	For enclosure		Mounting plate dimensions	
	H	W	h	w
MP1206	1200	600	1094	494
MP1208	1200	800	1094	694
MP1212	1200	1200	1094	1094
MP1406	1400	600	1294	494
MP1408	1400	800	1294	694
MP1410	1400	1000	1294	894
MP1412	1400	1200	1294	1094
MP1405	1400	500	1294	494
MP1606	1600	600	1494	494
MP1608	1600	800	1494	694
MP1610	1600	1000	1494	894
MP1612	1600	1200	1494	1094
MP1605	1600	500	1494	494
MP1804	1800	400	1694	294
MP1805	1800	500	1694	394
MP1806	1800	600	1694	494
MP1808	1800	800	1694	694
MP1810	1800	1000	1694	894
MP1812	1800	1200	1694	1094
MP1816	1800	1600	1694	1494
MP1818	1800	1800	1694	1694
MP2004	2000	400	1894	294
MP2005	2000	500	1894	394
MP2006	2000	600	1894	494
MP2008	2000	800	1894	694
MP2010	2000	1000	1894	894
MP2012	2000	1200	1894	1094
MP2016	2000	1600	1894	1494
MP2018	2000	1800	1894	1694
MP2206	2200	600	2094	494
MP2208	2200	800	2094	694
MP2210	2200	1000	2094	894
MP2212	2200	1200	2094	1094

500 mm width mounting plates for side mounting available on request.  
 1600 mm wide mounting plates are supplied as two 800 mm wide mounting plates along with a MPF filler plate.  
 All measurements in mm.

## Mounting plate brackets, MPA-P

- Description:** To fix mounting plates in the enclosure, including brackets for depth adjustment in steps of 25 mm. Brackets are needed when an extra mounting plate is required or when the enclosure is ordered without mounting plate (PE).
- Material:** 3 mm zinc plated steel.
- Pack quantity:** 2 top brackets, 2 bottom sliding brackets and 2 adjustment brackets with mounting accessories.

Catalog no.
MPA06



## Mounting plate adjustment brackets, MPD

- Description:** Brackets to adjust the mounting plate in depth by steps of 25 mm in the enclosure frame.
- Material:** 3 mm zinc plated steel.
- Pack quantity:** 2 brackets with mounting accessories.

Catalog no.
MPD02



Scan QR code to watch an instructional video

## Mounting brackets rear fixing, MPA-RF

- Description:** To fix mounting plates in the enclosure. Brackets are needed when an extra mounting plate is required or when the enclosure is ordered without mounting plate (PE).
- Material:** 3 mm zinc plated steel.
- Pack quantity:** 2 top brackets and 2 bottom sliding brackets with mounting accessories.

Catalog no.
MPA04



# Modular

## Accessories

### Mounting plate back-to-back bracket kit, MPBB

- Description:** To mount two mounting plates back to back at any depth within the enclosure's usable space, the position can be adjusted in steps of 25 mm. The space between the mounting plates is less than 10 mm, maximizing the free usable space for customer use.
- Material:** 3 mm zinc plated steel.
- Pack quantity:** 2 top brackets, 4 side brackets, 4 bottom brackets with mounting accessories.



Catalog no.
MPBB06

### Side mounting plate brackets, MPS

- Description:** To mount the standard mounting plate on the side of the enclosure's frame. Provides a mounting surface that is flush with the profiles.
- Material:** 3 mm zinc plated steel.
- Pack quantity:** 4 brackets with mounting accessories.



Catalog no.
MPS04



Scan QR code to watch an instructional video

## Filler plates, MPF

**Description:** Covers the space between pairs of adjacent mounting plates to provide a continuous working surface, when two enclosures are mounted together.

**Material:** 2 mm zinc plated steel.

**Pack quantity:** 1 plate with mounting accessories.

Catalog no.	For enclosure
	H
MPF1400	1400
MPF1600	1600
MPF1800	1800
MPF2000	2000
MPF2200	2200

*For bayed configurations MPD02 must be used along with the fixation brackets supplied with the enclosure and mounting plate. MPA06 must be used if the enclosure comes without fixation brackets. MPF cannot be used with mounting plates if they are installed in the most rear position.*

All measurements in mm.



Scan QR code to watch an instructional video

## Mounting plate hinge kit, MPH

**Description:** Allows the mounting plate to be opened up to 105°.

**Pack quantity:** 1 complete kit with accessories for one mounting plate.

**Mounting requirements:** Always use in combination with the CB carrier bar.

Catalog no.
MPH01

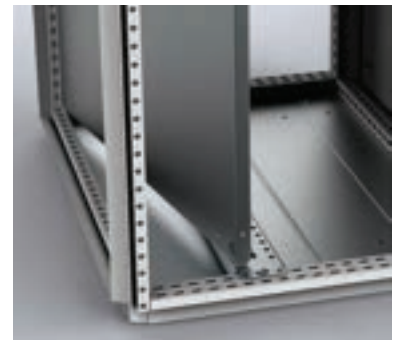

Scan QR code to watch an instructional video

# Modular

## Accessories

### Partial height mounting plates, MPP

**Description:** Mounted directly on the enclosure's frame or onto the click-in profiles (CLPK). Special design of the bracket allows one-person assembly. Can be mounted in any height or depth position within the 25 mm hole pattern. Appropriate sizes can also be used on the sides of the enclosure.

**Material:** 3 mm galvanized steel.

**Pack quantity:** 1 plate with mounting accessories.

**Mounting requirements:** Add CLPK for depth adjustment.

**Note:** MPP can be mounted in both directions.

Catalog no.	For enclosure		Mounting plate dimensions	
	H/W	W/H	h/w	w/h
MPP0404	400	400	294	294
MPP0405	400	500	294	394
MPP0604	600	400	494	294
MPP0605	600	500	494	394
MPP0606	600	600	494	494
MPP0608	600	800	494	694
MPP0610	600	1000	494	894
MPP0804	800	400	694	294
MPP0805	800	500	694	394
MPP0808	800	800	694	694
MPP1004	1000	400	894	294
MPP1008	1000	800	894	694
MPP1204	1200	400	1094	294
MPP1206	1200	600	1094	494

All measurements in mm.



Scan QR code to watch an instructional video

## Wide mounting plates, MPW

- Description:** Creates an installation surface over the full width of the enclosure. Easy installation by use of sliding profiles MTS from the side. Nominal width equals the enclosure width. When combining enclosures the MPWs can be connected and slid in as one installation surface. Can not be mounted in the rearmost position.
- Material:** 3 mm galvanized steel.
- Pack quantity:** 1 piece with mounting accessories.
- Mounting requirements:** Add sliding profiles MTS. MPW fits in combinable enclosures only.



Scan QR code to watch an instructional video

Catalog no.	For enclosure	
	H	W
MPW1805	1800	500
MPW1806	1800	600
MPW1808	1800	800
MPW1810	1800	1000
MPW1812	1800	1200
MPW1816*	1800	1600
MPW2005	2000	500
MPW2006	2000	600
MPW2008	2000	800
MPW2010	2000	1000
MPW2012	2000	1200
MPW2016*	2000	1600

\* 1600 mm wide mounting plates are supplied as two 800 mm wide mounting plates.

All measurements in mm.

# Modular

## Accessories

### Transversal sliding profiles, MTS

- Description:** To be used when installing a wide mounting plate. Adjustable in depth in steps of 25 mm.
- Material:** 3 mm zinc plated steel.
- Pack quantity:** 2 profiles with mounting accessories.

Catalog no.	For enclosure
	W
MTS500	500
MTS600	600
MTS800	800
MTS1000	1000
MTS1200	1200
MTS1600	1600

All measurements in mm.



Scan QR code to watch an instructional video

### Roller for sliding profiles, MTS01W

- Description:** Reducing the force to be applied during the side-mounting, especially if the MPW/MP is heavily loaded.
- Material:** Plastic.
- Pack quantity:** One roller with mounting accessories.

Catalog no.
MTS01W



### Mounting plate fixing brackets, MPE

- Description:** For extra support of the mounting plate in the middle, in addition to the normal top and bottom fixing.
- Material:** 3 mm zinc plated steel.
- Pack quantity:** 10 pieces.
- Mounting requirements:** Add CMB profiles.

Catalog no.
MPE10

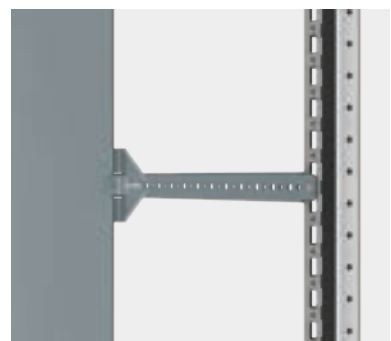

## Flush mounting plate fixing brackets, MPEF

**Description:** For extra fixing of a heavily equipped mounting plate in the far rear position. Mounted directly to the enclosure frame for extra stability. Easy mounting without drilling. Can be fixed from the front even after the mounting plate is already in position. The combination with an MPR profile is advised.

**Material:** 3 mm zinc plated steel.

**Pack quantity:** 10 pieces with mounting accessories.

Catalog no.
MPEF10



## Mounting plate reinforcement profiles, MPR

**Description:** Reinforcing a mounting plate (MP) when heavily equipped. For dampening of vibrations and stabilization. Easy mounting without drilling. To achieve maximum damping, fixing of the mounting plate to the profile is advised.

**Material:** 2 mm galvanized steel.

**Pack quantity:** 2 profiles with mounting accessories.

Catalog no.	For enclosure
	W
MPR1000	1000
MPR1200	1200
MPR1600	1600



All measurements in mm.

# Modular

## Accessories

### Mounting plate reinforcement profiles, MPWR

- Description:** Reinforcing a wide mounting plate (MPW) when heavily equipped. For dampening of vibrations and stabilization. Easy mounting without drilling. To obtain maximum damping, fixing of the mounting plate to the profile is advised.
- Material:** 2 mm galvanized steel.
- Pack quantity:** 2 profiles with mounting accessories.

Catalog no.	For enclosure
	W
MPWR1000	1000
MPWR1200	1200

All measurements in mm.



### Click-in profiles, CLPK

- Description:** Universal profile for both depth and width fitting on the 25 mm DIN hole pattern of the enclosure's frame or in combination with the CLPF and VB profiles. The 75 mm wide profile is equipped with three rows of holes of which one is turned 90°. This makes it possible to mount the CLPF profiles in both directions. The CLPK can be secured by the use of self tapping screws.
- Material:** 1.5 mm zinc plated steel.
- Pack quantity:** 4 profiles.

Catalog no.	For enclosure	
	W/D	Max. loading
CLPK400	400	2000 N
CLPK500	500	2000 N
CLPK600	600	1600 N
CLPK800	800	1600 N
CLPK1000	1000	1200 N
CLPK1200	1200	1200 N

All measurements in mm.

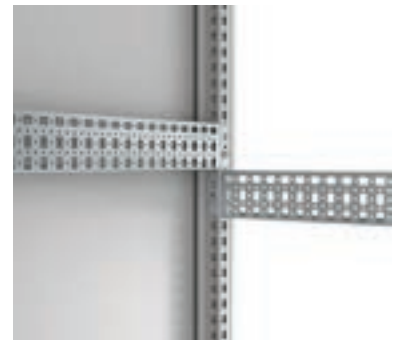

## Mounting profiles, CLPF

**Description:**

The CLPF profile system is a 40 mm wide and 25 mm high profile, which can be mounted in all directions on the enclosure's frame. It can also be used in combination with the CLPK and the VB profiles. By turning the profile it can be used as a standard CP20/40 profile in combination with GLM 40/6 sliding nut, to mount installation material which needs adjusting in depth. The profiles, when mounted onto the enclosure's frame are flush with the enclosure's profiles. Two rows of hole patterns for cage nut fixing and self tapping screws are provided. For 90 mm wide profiles two profiles can be mounted next to each other.

**Material:**

Zinc plated steel.

**Pack quantity:**

4 profiles including snap-line for fixing.



Scan QR code to watch an instructional video

Catalog no.	For enclosure		Max. loading Horizontal C	Max. loading Horizontal
	H/W	W/D		
CLPF400	400	400	800 N	1000 N
CLPF500	500	500	800 N	1000 N
CLPF600	600	600	800 N	1000 N
CLPF800	800	800	800 N	1000 N
CLPF1000	1000	1000	800 N	1000 N
CLPF1200	1200	1200	Only vertical loads allowed	Only vertical loads allowed
CLPF1400	1400	1400	Only vertical loads allowed	Only vertical loads allowed
CLPF1600	1600	1600	Only vertical loads allowed	Only vertical loads allowed
CLPF1800	1800	1800	Only vertical loads allowed	Only vertical loads allowed
CLPF2000	2000	2000	Only vertical loads allowed	Only vertical loads allowed
CLPF2200	2200	2200	Only vertical loads allowed	Only vertical loads allowed

All measurements in mm.

# Modular

## Accessories

### Side mounting bars, CMB

- Description:** For fixing cables, cable guides, etc, in the depth or the width of an enclosure.
- Material:** 2 mm zinc plated steel.
- Pack quantity:** 20 profiles with mounting accessories.

Catalog no.	For enclosure
	W/D
CMB402	400
CMB502	500
CMB602	600
CMB802	800

All measurements in mm.



### Height profiles, HP

- Description:** Vertical profiles with 25 mm hole pattern, to support DIN rails and appropriate telequick mounting plates. Adjustable in depth in steps of 25 mm.
- Material:** 2 mm zinc plated steel.
- Pack quantity:** 2 profiles with mounting accessories.

Catalog no.	For enclosure
	H
HP1600	1600
HP1800	1800
HP2000	2000
HP2200	2200

All measurements in mm.

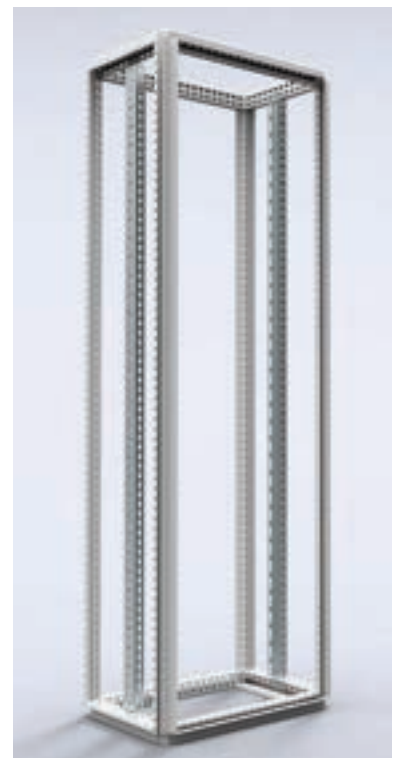

## Cage nuts, CNM

**Description:** Cage nuts designed for universal use on the enclosure frame profiles and the profiles system.

**Pack quantity:** 50 pieces.

Catalog no.	Thread
CNM615	M6
CNM815	M8



## Screws for clip-on cage nuts, CNS

**Description:** Socket head screws M6x12 and M8x12 for clip-on cage nuts.

**Pack quantity:** 250 pieces.

Catalog no.	Thread
CNS612	M6
CNS812	M8



## Extrude-tite screws, CNT

**Description:** Torx extrude-tite screws for fitting accessories, click in profiles, earthing etc.

**Pack quantity:** 250 pieces.

Catalog no.	Thread
CNT05	M5
CNT06	M6



# Modular

## Accessories

### Extrude-tite screws for stainless steel profiles, CNTS

**Description:** To be used in the DIN pattern of round holes on the stainless steel enclosure frame. Torx extrude-tite screws for fitting accessories.

**Pack quantity:** 250 pieces.

Catalog no.	Thread
CNTS05	M5
CNTS06	M6



### Carrier bars, CB

**Description:** Used for heavy equipment, such as transformers, fitted in the bottom of the enclosure.

**Material:** 3 mm zinc plated steel.

**Pack quantity:** 1 pair with mounting accessories.

Catalog no.	For enclosure	
	W/D	Max. loading
CB400	400	2500 N
CB500	500	2100 N
CB600	600	1800 N
CB800	800	1300 N

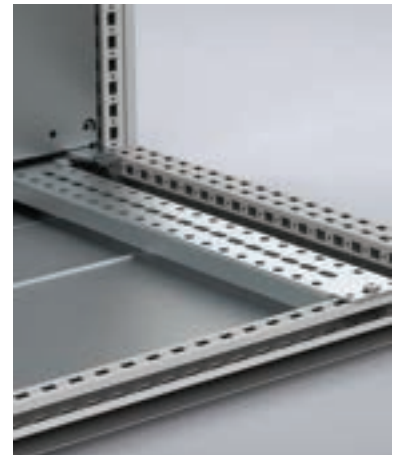

*The maximum load is indicated per bar.*  
All measurements in mm.

## Heavy duty carrier bars, CBU

**Description:** Heavy duty carrier bar for mounting heavy components (e.g. transformers). Supplied with T-shaped sliding bolts and equipped with slotted holes for mounting in any position, both in width and depth of the enclosure.

**Material:** 2.5 mm zinc plated steel.

**Pack quantity:** 1 pair with mounting accessories and 4 T-shaped sliding bolts.

	For enclosure	
Catalog no.	W/D	Max. loading
CBU400	400	3000 N
CBU500	500	3000 N
CBU600	600	3000 N
CBU800	800	2250 N
CBU1000	1000	1800 N
CBU1200	1200	1500 N

*The maximum load is indicated per bar.*

All measurements in mm.

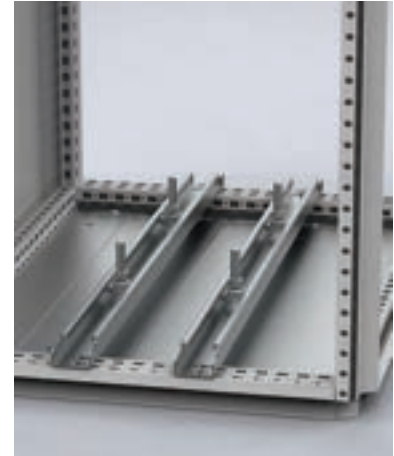

## Adjustment profiles, APK

**Description:** Width profiles which allows for continuous adjustment of fixation cage nuts for components in height, depth and width. Panel builders can then fix any component in the desired position without machining.

**Material:** 2,5 mm galvanized steel.

**Pack quantity:** 2 pairs.

**Requirements:** To be assembled on CLPF depth profiles.

	For enclosure
Catalog no.	W
APK600	600
APK800	800

All measurements in mm.



# Modular

## Accessories

### Full Height Swing Frames, ESFC

- Description:** Full height swing frame for 19" components allowing left and right hand opening. Can be used in steel, combinable and compact enclosures. Hinges designed to give extra build-in depth. Adjustable top hinge for square mounting of the swing frame. Rigid W-shaped frame profile for heavy equipment. Zinc plated 19" vertical profiles for direct earthing of the mounted components. Standard equipped with 130° hinges (180° hinges not applicable for 600 mm wide enclosures). Can also be mounted on the side of 600 mm deep floor standing enclosures. For steel, combinable enclosures use transversal support bars ESFB in combination with VBD if required. Adjustable in depth by steps of 12.5 mm.
- Maximum load:** 1800 N, supplied with a self positioning device.
- Lock:** Two 3 mm double-bit locks.
- Material:** 19" vertical profiles 2 mm zinc plated steel. Frame: vertical profiles 2 mm and horizontal profiles 3 mm.
- Pack quantity:** 1 swing frame with hinges.
- Mounting requirements:** ESFC for 600 mm, 800 mm, 1000 mm, 1200 mm wide steel, combinable enclosures. Add ESFB for mounting in a steel, combinable enclosure.

Catalog no.	For enclosure		
	H	U	h
ESFC276	1400	27	1267
ESFC316	1600	31	1445
ESFC366	1800	36	1667
ESFC406	2000	40	1845
ESFC456	2200	45	2067

All measurements in mm.



Scan QR code to watch an instructional video

## Swing Frame middle mounted, ESFM

- Description:** Full height swing frame for 19" components allowing left and right hand opening with grip over the full height. Can be used in steel, combinable and compact enclosures. Hinges designed to give extra build-in depth. Adjustable top hinge for square mounting of the swing frame. Rigid W-shaped frame profile for heavy equipment. Zinc plated 19" vertical profiles for direct earthing of the mounted components. Full access to the enclosure aperture can be acquired by the standard fitted 180° hinges. For mounting use transversal support bars ESFB. Depth support and easy cable routing is achieved with depth mounting plate SFMP. Adjustable in depth by steps of 12.5 mm.
- Maximum load:** 1800 N, supplied with a self-positioning device.
- Lock:** Double-bit 3 mm espagnolette (other lock options possible).
- Material:** 19" vertical profiles 2 mm zinc plated steel. Frame: vertical profiles 2 mm and horizontal profiles 3 mm.
- Finish:** RAL 7035 structured powder coating.
- Pack quantity:** 1 swing frame with 180° hinges.
- Mounting requirements:** ESFM for 800 mm and 1000 mm wide steel, combinable enclosures. Add ESFB for mounting in a steel, combinable enclosure.

Catalog no.	For enclosure		
	H	U	h
ESFM278	1400	27	1267
ESFM318	1600	31	1445
ESFM368	1800	36	1667
ESFM408	2000	40	1845
ESFM458	2200	45	2067

All measurements in mm.



Scan QR code to watch an instructional video

# Modular

## Accessories

Modular Enclosures

### Swing Frame side mounted, ESFS

- Description:** Full height swing frame for 19" components allowing left and right hand opening with grip over the full height. Can be used in steel, combinable and compact enclosures. Hinges designed to give extra build-in depth. Adjustable top hinge for square mounting of the swing frame. Rigid W-shaped frame profile for heavy equipment. Zinc plated 19" vertical profiles for direct earthing of the mounted components. Standard equipped with 130° hinges. Full access to the enclosure's aperture can be acquired by use of 180° hinges ESFH180. For mounting use transversal support bars ESFB. Depth support and easy cable routing is achieved with depth mounting plate SFMP. Adjustable in depth by steps of 12.5 mm.
- Maximum load:** 1800 N, supplied with a self-positioning device.
- Lock:** Double-bit 3 mm espagnolette (other lock options possible).
- Material:** 19" vertical profiles 2 mm zinc plated steel. Frame: vertical profiles 2 mm and horizontal profiles 3 mm.
- Finish:** RAL 7035 structured powder coating.
- Pack quantity:** 1 swing frame with hinges.
- Mounting requirements:** ESFS for 800 mm, 1000 mm wide steel, combinable enclosures. Add ESFB for mounting in a steel, combinable enclosure.

Catalog no.	For enclosure		
	H	U	H2
ESFS408	2000	40	1845
ESFS458	2200	45	2067

All measurements in mm.



Scan QR code to watch an instructional video

## Swing Frame transversal support bars, ESFB

**Description:** For full height mounting of swing frames in steel, combinable and compact enclosures. When partial height mounting is required use the ESFB in combination with CLPK or CLPF. The swing frames can be mounted both left and right hand opening. One man installation with integrated safety catch which holds the swing frame in the mounting position (130° hinge). Pre-punched holes for mounting a door switch (DSW01) is provided in the top swing frame support with W>600 mm and with ESFS or ESM swing frames.

**Material:** 3 mm zinc plated steel.

**Mounting requirements:** Support bars (ESFB) 600 mm wide can also be mounted directly into a 1200 mm wide enclosure by means of a VBD. Support bars (ESFB) 800 mm wide can also be mounted directly in 1600 mm wide enclosures.

**Pack quantity:** One complete kit for a swing frame.

Catalog no.	For enclosure
	W
ESFB06	600
ESFB08	800
ESFB10	1000
ESFB12	1200

To mount 2 x ESFC swing frames, an additional mounting kit ESFB12XKIT is required.  
All measurements in mm.



## Swing frame door stop, ESFD

**Description:** To enable locking of the swing frame in the open position. Mounted directly onto the swing frame and support bars. The door stop can be easily disconnected to provide full opening of the swing frame.

**Material:** Zinc plated steel.

**Pack quantity:** 1 piece with mounting accessories.

Catalog no.	Opening degree
ESFD130	130°
ESFD180	180°



# Modular

## Accessories

Modular Enclosures

### Swing Frame hinges 180°, ESFH

- Description:** Allows the swing frame to be opened up to 180°. Adjustable top hinge for square mounting of the swing frame. Smart hinge point position giving maximum build-in depth.
- Material:** Zinc plated steel.
- Pack quantity:** 1 set.
- Mounting requirements:** To be used in combination with ESFS mounted in 800 mm, 1000 mm and 1200 mm wide enclosures.

Catalog no.
ESFH180



### Swing Frame chassis support, SFSU

- Description:** To add in-depth support and relieve pressure on heavy chassis applications.
- Material:** 2 mm zinc plated steel.
- Pack quantity:** 1 pair with mounting accessories.
- Mounting requirements:** For full height swing frames the SFMP can be added for more in-depth support and easy cable routing. Mounted directly to the back of the swing frame or to the Swing Frame mounting plate SFMP.

Catalog no.
SFSU02



## Partial height swing frames, SFCP

- Description:** Partial height swing frame for 19"-components allowing left or right hand opening. Can be used in wall mounted, steel enclosures, and floor standing, combinable and compact, steel enclosures. Rigid S-shaped frame profile equipped with 19" hole pattern in front and back. Zinc plated frame for direct earthing of the mounted components. Standard opening angle 125°–155°.
- Lock:** 1 double-bit 3 mm lock.
- Material:** 2 mm zinc plated steel.
- Pack quantity:** 1 swing frame with hinges.
- Mounting requirements:** Mounting in wall mounted, steel enclosures requires the SFBP transversal support in combination with the AVB. Mounting in floor standing steel combinable enclosures requires the SFBP transversal support. Adjustable in depth in combination with CLPK profiles.



Catalog no.	For enclosure		Max. loading
	H	U	
SFCP036	600	3	150 N
SFCP066	600	6	300 N
SFCP106	600	10	500 N
SFCP126	800	12	500 N
SFCP156	800	15	500 N
SFCP196	1000	19	500 N
SFCP246	1200	24	500 N

All measurements in mm.

## Partial SF transversal brackets, SFBP-B

- Description:** Enables partial height swing frames to be mounted in floor standing, combinable and compact, steel enclosures with full access to the enclosure's aperture. The swing frame can be mounted to allow both left and right hand opening.
- Material:** 3 mm zinc plated steel.
- Pack quantity:** 1 complete kit for one swing frame.
- Mounting requirements:** The SFBP can be used in double door enclosures by means of the VB/CDV divider profile. For depth adjustment use CLPK profiles.



Catalog no.
SFBP03

# Modular

## Accessories

### Partial SF transversal support bars, SFBP

- Description:** Enables partial height swing frames to be mounted in wall mounted, steel enclosures, and floor standing, combinable, steel enclosures. The swing frames can be mounted to allow both left and right hand opening.
- Material:** 3 mm zinc plated steel.
- Pack quantity:** 1 complete kit including mounting brackets for one swing frame.
- Mounting requirements:** For wall mounted, steel enclosures, use in combination with the AVB profiles. For floor standing enclosures, it can be mounted directly to the enclosure frame or adjustable in depth, in steps of 25 mm, by means of the CLPK.



Catalog no.	For enclosure	
	W	
SFBP600	600	
SFBP800	800	

All measurements in mm.

### 19" Mounting profiles, CIP

- Description:** Full height mounting profiles to achieve 482.6 mm (19") mounting requirements on all sides. Fully adjustable in depth.
- Material:** 2 mm zinc plated steel.
- Pack quantity:** 1 pair.
- Mounting requirements:** To be used in conjunction with CIB or CID profiles. For partial height mounting the CIWR is required.

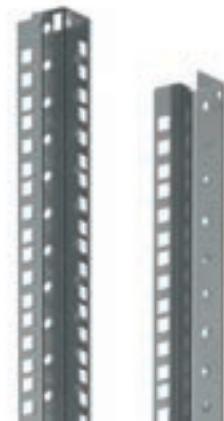

Catalog no.	For enclosure	
	H	U
CIP20	1000	20
CIP22	1100	22
CIP24	1200	24
CIP29	1400	29
CIP33	1600	33
CIP38	1800	38
CIP42	2000	42
CIP47	2200	47

All measurements in mm.

## Profiles for 19" profiles fixing, CIB

- Description:** For fitting 19" vertical profiles CIP/CIPD in 600 mm and 800 mm wide enclosures. Fully adjustable in depth.
- Material:** 3 mm zinc plated steel.
- Pack quantity:** 2 profiles with mounting accessories.

Catalog no.	For enclosure	
	W	
CIB600	600	
CIB800	800	

All measurements in mm.

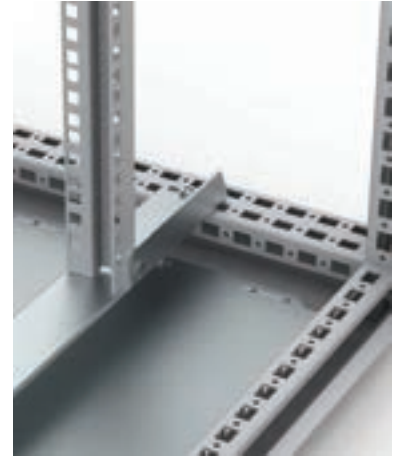

## Profiles for 19" profiles asymmetric fixing, CID

- Description:** For fitting asymmetric 19" mounting profiles CIP/CIPD in 800 mm or wider enclosures. Fully adjustable in depth. Especially suited when heavier (active) components will be fitted.
- Material:** 3 mm zinc plated steel.
- Pack quantity:** 4 profiles with mounting accessories.

Catalog no.	For enclosure	
	W	D
CID600	800/1000	600
CID800	800/1000	800

All measurements in mm.



# Modular

## Accessories

### 19" Mounting profiles, CIPD

- Description:** Side universal 19" punching. For additional internal support.
- Material:** 2 mm zinc plated steel.
- Pack quantity:** 1 pair.
- Mounting requirements:** To be used in conjunction with CIB or CID profiles. For partial height mounting the CIWR is required.

Catalog no.	For enclosure	
	H	U
CIPD33	1600	33
CIPD38	1800	38
CIPD42	2000	42
CIPD47	2200	47

All measurements in mm.

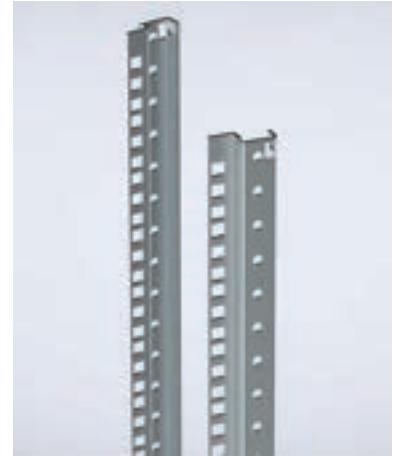

### Brackets for 19" partial height mounting profiles, CIC

- Description:** For fixing 19" vertical profiles CIPP in 800 mm wide enclosures. Adjustable in depth in steps of 25 mm by using the CLPK click-in profiles.
- Material:** 3 mm zinc plated steel.
- Pack quantity:** 4 brackets with mounting accessories.

Catalog no.
CIC04



## 19" partial height mounting profiles, CIPP

- Description:** Partial height 19" vertical profiles to achieve 482.6 mm (19") mounting requirements on all sides. Adjustable in depth in steps of 25 mm using the CLPK click-in profiles.
- Material:** 2 mm zinc plated steel.
- Pack quantity:** 2 pieces with mounting accessories.
- Mounting requirements:** To be used with brackets CIC in 800 mm wide enclosures.



Catalog no.	U
CIPP06	6
CIPP09	9
CIPP10	10
CIPP11	11
CIPP13	13
CIPP15	15
CIPP18	18

All measurements in mm.

## 19" Width reducers, CIWR

- Description:** Used to obtain 19" mounting facilities in 800 mm wide enclosures. Allows the mounting of CIP/CIPP profiles on partial or full height at any depth.
- Material:** 2 mm zinc plated steel.
- Maximum load:** Maximum supported weight is 5000N on 2 pair of CIWR and 8000N on 3 pair of CIWR.
- Pack quantity:** 1 pair with mounting accessories.



Catalog no.	For enclosure		
	W	D	w
CIWR8196	800	600	19"
CIWR8198	800	800	19"

All measurements in mm.

# Modular

## Accessories

### Front frame cover, FFC

- Description:** To cover the framework around the door aperture on 600 mm wide data-telecom enclosures, when a door is not fitted.
- Material:** 1.75 mm steel plate.
- Finish:** RAL 7035 structured powder coating.
- Pack quantity:** 1 set with mounting accessories.



Catalog no.	Enclosure dimensions		Height U
	H	W	
FFC1806R5	1800	600	38
FFC1808R5	1800	800	38
FFC2006R5	2000	600	42
FFC2008R5	2000	800	42
FFC2206R5	2200	600	47
FFC2208R5	2200	800	47

All measurements in mm.

### Front Phillips screws, CHS

- Description:** For the mounting of front closing panels (PAC/PAL) or shelves on to the 19" profiles. To be used in combination with plastic washer PW6.
- Length:** 16 mm.
- Pack quantity:** 50 pieces.



Catalog no.	Thread
CHS616	M6

### Plastic washers, PW

- Description:** Plastic washer for the M6 front Phillips screws (CHS). To prevent damaging the front of the patch panels.
- Pack quantity:** 50 pieces.



Catalog no.
PW6

## Cage nuts, CN

**Description:** For 2 mm steel thickness.

**Pack quantity:** 50 pieces.

Catalog no.	Thread
CN6	M6

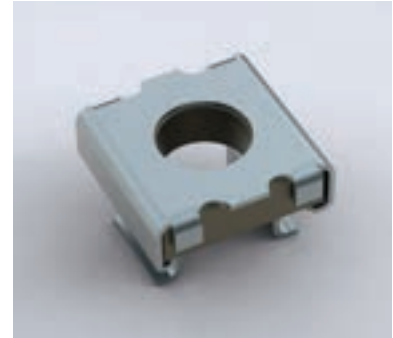

## Friction slide, L

**Description:** To support heavy components which are only fitted to the front. Mounted between two 19" profiles. Version fixed with 2 screws per profile, and version with click-in fixation.

**Material:** Click-in version 1.5 mm and mounted version 3 mm zinc plated steel.

**Pack quantity:** 1 pair with fixing material.

Catalog no.	Length	Type	Max. loading
L279	279	screwed	980 N
L406	406	screwed	980 N
L406C	406	click-in	490 N
L470	470	screwed	980 N
L470C	470	click-in	490 N
L597	597	screwed	980 N
L700	700	screwed	980 N

All measurements in mm.



## 1U Keyboard tray, DKB

**Description:** For the installation of narrow 19" wide keyboard for PC, server or control system. Mounted directly to existing 19 inch profiles in front and rear.

**Material:** 1.25 mm steel.

**Finish:** RAL 7035.

**Pack quantity:** 1 keyboard tray with telescopic rails and fixing accessories.

Catalog no.	H	W	D	U
DKB02	32	406	182	1

All measurements in mm.



# Modular

## Accessories

### 19" shelf, VSF

- Description:** Maximum loading capacity when mounted directly onto the 19" profiles, front and rear. Ventilation openings.
- Material:** 1.5 mm steel.
- Finish:** RAL 7035.
- Pack quantity:** 1 shelf with mounting material.

Catalog no.	For enclosure		Max. loading
	W	D	
VSF1406	19"	500	1200 N
VSF1470	19"	600	1200 N
VSF1597	19"	700	1200 N

All measurements in mm.



### 19" telescopic shelf, VTS

- Description:** Mounted directly onto the 19" profiles, front and rear, 1U high. Ventilation openings.
- Material:** 1 mm steel.
- Finish:** RAL 7035.
- Pack quantity:** 1 shelf and 2 quick mounting 3-member slides, front handle and mounting material.

Catalog no.	W	For enclosure		Max. loading
		D		
VTS1470	19"	500		500 N
VTS1597	19"	600		500 N

All measurements in mm.



## Painted steel front panels, PAC

- Description:** Plain 19" front panel.  
**Material:** 3 mm steel.  
**Finish:** RAL 7035.  
**Pack quantity:** 1 piece.

Catalog no.	Height U	W	h
PAC01	1	19"	44.45
PAC02	2	19"	88.90
PAC03	3	19"	133.35
PAC04	4	19"	177.80
PAC06	6	19"	266.70

All measurements in mm.



## Ventilated shelves, SHC

- Description:** Mounted directly onto the enclosure's frame.  
**Material:** 2 mm zinc plated steel.  
**Maximum load:** 500 N.  
**Pack quantity:** 1 shelf with mounting accessories.

Catalog no.	For enclosure		Ventilated Shelf Dimensions	
	W	D	w	d
SHC0606	600	600	509	555
SHC0608	600	800	509	755
SHC0806	800	600	709	555
SHC0808	800	800	709	755
SHC0809	800	900	709	855

All measurements in mm.



# Modular

## Accessories

### Telescopic ventilated shelf, SHT

- Description:** For easy access to installed equipment. Mounted directly to the enclosure's frame. Partial depth mounting is an option. Possibility to take the shelf out of the slides even after mounting into the enclosure. Reversed and side mounting possible.
- Material:** 2 mm zinc plated steel.
- Maximum load:** 500 N.
- Pack quantity:** 1 ventilated shelf and 1 pair of telescopic slides with mounting accessories.
- Mounting requirements:** Add SHTP profiles for full/partial depth installation to the enclosure's frame.



Catalog no.	For enclosure		Shelf dimensions	
	W	D	w	d
SHT0606	600	600	460	550
SHT0608	600	800	460	750
SHT0806	800	600	660	550
SHT0808	800	800	660	750

All measurements in mm.

### Telescopic shelf HD, SHTH

- Description:** For easy access to installed equipment. Mounted directly to the enclosure's frame with integrated handle. Reversed mounting possible.
- Material:** 2 mm zinc plated steel.
- Maximum load:** 1000 N.
- Pack quantity:** 1 ventilated shelf and 1 pair of telescopic slides with mounting accessories.

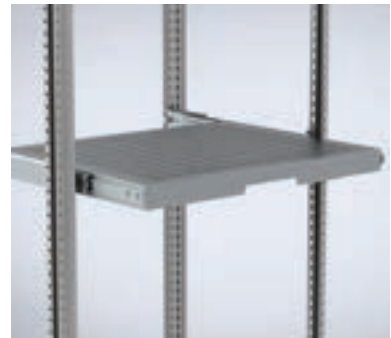

Catalog no.	For enclosure	
	W	D
SHTH0606	600	600
SHTH0608	600	800
SHTH0806	800	600
SHTH0808	800	800

All measurements in mm.

## Mounting profiles for SHT, SHTP

- Description:** Profiles for partial and full depth mounting of the telescopic shelf SHT. Makes possible to mount a 600 mm deep SHT in a 800 mm deep enclosure. Fixed directly to the enclosure's frame. Fully adjustable in height in steps of 12.5 mm.
- Material:** 1.5 mm zinc plated steel.
- Pack quantity:** 2 profiles with mounting accessories.

Catalog no.	For enclosure	
	D	
SHTP600	600	
SHTP800	800	

All measurements in mm.



## Seismic Bracket Kit, SBK-Z4

- Description:** Reinforcement Kit to be added to standard MCS enclosures in order to reach a Seismic Zone 4 rating.
- Material:** Galvanized steel.
- Pack quantity:** 1 Assembly per order.
- Mounting requirements:** Complete assembly with SPM Side panels, but mounted with seismic hardware included in SBK Kit delivery.

Catalog no.	For enclosure	
	H	D
SBK18XX4Z4	1800	400
SBK18XX6Z4	1800	600
SBK18XX8Z4	1800	800
SBK20XX4Z4	2000	400
SBK20XX6Z4	2000	600
SBK20XX8Z4	2000	800

All measurements in mm.



## Seismic Plinth Base, PSB-Z4

- Description:** Seismic Plinth base to be added to standard MCS enclosures to be used in a Seismic Zone 4 rating.
- Material:** Mild steel.
- Pack quantity:** 1 Assembly per order.

Catalog no.	H	W	D
PSB0604Z4	100	600	400
PSB0606Z4	100	600	600
PSB0806Z4	100	800	600
PSB0808Z4	100	800	800
PSB1008Z4	100	1000	800

All measurements in mm.



# Modular

## Accessories

### Front/rear Plinths, PF

**Description:** Front and rear plinth sections. For cabling without any restrictions and in accordance with the VDE 0113 standard. The plinth consists of four corner pieces with removable front covers. The side panels PS are to be ordered separately. Produced in 100 mm and 200 mm heights. 200 mm high plinths are delivered with a rear cover for cabling that consists of two removable panels 100 mm high. The front cover is a one piece panel of 200 mm high. All panels have double returns on each side for added strength.

**Material:** Corner pieces in 2 mm and panels in 1.5 mm mild steel.

**Finish:** RAL 7022 structured powder coating.

**Pack quantity:** 1 set of 4 corner pieces including covers. Front and rear panel (2 rear panels for 200 mm high plinths) with mounting accessories. Mounting accessories for side panels PS or transversal profiles PCP.

**Mounting requirements:** Add the side panels PS for a complete plinth. When combining enclosures it is recommended to add transversal panels PCP for cable duct support and extra rigidity.



Scan QR code to watch an instructional video

Catalog no.	For enclosure	
	H	W
PF1040	100	400
PF1050	100	500
PF1060	100	600
PF1070	100	700
PF1080	100	800
PF1090	100	900
PF1100	100	1000
PF1120	100	1200
PF1140	100	1400
PF2040	200	400
PF2050	200	500
PF2060	200	600
PF2070	200	700
PF2080	200	800
PF2090	200	900
PF2100	200	1000
PF2120	200	1200

*For enclosures 1600 mm wide use 2 x 800 mm wide plinth.*  
All measurements in mm.

## Ventilated front/rear plinths, PV

- Description:** Front and rear plinth sections with ventilated panels. Recommended to be used in combination with the ventilated bottom plate CVB. For cabling without any restrictions and in accordance with the VDE 0113 standard. The plinth consists of four corner pieces with removable front covers. All panels have double returns for added strength. Only available in height of 100 mm.
- Material:** Corner pieces in 2 mm and panels in 1.5 mm mild steel.
- Finish:** RAL 7022 structured powder coating.
- Pack quantity:** 1 set of 4 corner pieces including covers. Front and rear panel with mounting accessories for side panels PS or transversal profiles PCP.
- Mounting requirements:** Add the side panels PS for a complete plinth. When combining enclosures it is recommended to add transversal panels PCP for cable duct support and extra rigidity. Use ventilated bottom plates CVB to get better enclosure ventilation.

Catalog no.	For enclosure
	W
PV1040	400
PV1060	600
PV1080	800
PV1100	1000
PV1120	1200

All measurements in mm.



Scan QR code to watch an instructional video

# Modular

## Accessories

### Plinth combining profiles, PCP

- Description:** Acts as a stabiliser when cabling is routed between bayed enclosures. With the PCP, plinths can be combined and fixed to the floor before the enclosures are mounted on them. The PCP can be used when cables have to go under the enclosure. For 200 mm high plinths, the PCP can be mounted in three different heights, top, middle or bottom. The hole pattern for cage nuts and M5x10 screws, allows accessories to be mounted.
- Material:** 2 mm steel plate.
- Finish:** RAL 7022 structured powder coating.
- Pack quantity:** 2 profiles with mounting accessories.



Scan QR code to watch an instructional video

Catalog no.	For enclosure
	D
PCP04	400
PCP05	500
PCP06	600
PCP08	800
PCP10	1000

All measurements in mm.

## Side plinths, PS

- Description:** Side panels to cover the openings in the sides of the PF/PV plinths. Double folded panels for maximum strength. Compatible with combinable and semi-compact enclosure ranges.
- Material:** 1.5 mm steel plate.
- Finish:** RAL 7022 structured powder coating.
- Pack quantity:** 2 panels. Mounting accessories included with PF/PV.

Catalog no.	For enclosure	
	H	D
PS1030	100	300
PS1040	100	400
PS1050	100	500
PS1060	100	600
PS1080	100	800
PS1100	100	1000
PS2030	200	300
PS2040	200	400
PS2050	200	500
PS2060	200	600
PS2080	200	800
PS2100	200	1000

All measurements in mm.



Scan QR code to watch an instructional video

# Modular

## Accessories

### Leveling feet, LF

**Description:** Adjustable feet for leveling enclosures placed on uneven ground. Mounted directly to the enclosure's frame. Adjustment stroke: 30 mm.

**Maximum load:** 3000 N per foot.

**Pack quantity:** 4 pieces with mounting accessories.



Catalog no.
LF430

### Wall fixing brackets, CCB

**Description:** To fix the enclosure to the wall by using M12 screws on the top of the enclosure. Prevents the enclosure from tipping over e.g. on board ships. Compatible with combinable and compact mild steel floor standing enclosure ranges.

**Material:** 3 mm zinc plated steel.

**Pack quantity:** 2 pieces.



Catalog no.
CCB02

### Casters, LCR

**Description:** For easy transportation of an (equipped) enclosure. Can be mounted directly to the enclosure's frame or underneath the plinths (PF/PV) with the provided mounting brackets. Raises the enclosure by 70 mm.

**Maximum load:** 2800 N (Moving) or 5600 N (Static) per kit.

**Pack quantity:** 4 pieces with mounting accessories.



Catalog no.	Type
LCR470	4 casters without brakes
LCR471	2 casters with and 2 without brakes
LCR472	4 casters with brakes

## Glazed doors, DNG

- Description:** Glazed door with fitted clear safety glass to view the inside of the enclosure. Equipped with double-bit 3 mm lock system and door frame. Allows all options of the locking program. Compatible with combinable and compact enclosure ranges.
- Material:** Frame: 2 mm steel plate. Viewing area: 4 mm clear safety glass.
- Finish:** RAL 7035 structured powder coating.
- Protection:** Complies with IP 55 | TYPE 12 | IK 07.
- Pack quantity:** 1 piece.
- Mounting requirements:** Use hinge kit DNMK01 if no door was fitted previously.



Catalog no.	For enclosure		Mounting Plate dimensions	
	H	W	h	w
DNG1106R5	1100	600	876	415
DNG1206R5	1200	600	976	415
DNG1208R5	1200	800	976	615
DNG1406R5	1400	600	1176	415
DNG1408R5	1400	800	1176	615
DNG1606R5	1600	600	1376	415
DNG1608R5	1600	800	1376	615
DNG1806R5	1800	600	1576	415
DNG1808R5	1800	800	1576	615
DNG2006R5	2000	600	1776	415
DNG2008R5	2000	800	1776	615
DNG2010R5	2000	1000	1776	815
DNG2206R5	2200	600	1976	415
DNG2208R5	2200	800	1976	615
DNG2210R5	2200	1000	1976	815

All measurements in mm.

# Modular

## Accessories

### Plain doors, DN

- Description:** Standard door equipped with double-bit 3 mm lock system and door frame. Door accessory kit DNMK (hinges, rod catches) to be ordered separately. Allows all the options of the locking program and 180° hinges. Compatible with combinable and compact enclosure ranges.
- Material:** 2 mm steel plate.
- Maximum load:** 800 N.
- Finish:** RAL 7035 structured powder coating.
- Mounting requirements:** Use hinge kit DNMK if no door was fitted previously.
- Pack quantity:** 1 piece.

Plain door

Catalog no.	H	W
DN1106R5	1100	600
DN1206R5	1200	600
DN1208R5	1200	800
DN1406R5	1400	600
DN1408R5	1400	800
DN1606R5	1600	600
DN1608R5	1600	800
DN1610R5	1600	1000
DN1805R5	1800	500
DN1806R5	1800	600
DN1808R5	1800	800
DN1810R5	1800	1000
DN2005R5	2000	500
DN2006R5	2000	600
DN2008R5	2000	800
DN2010R5	2000	1000
DN2206R5	2200	600
DN2208R5	2200	800

All measurements in mm.

Right door of a double door enclosure

Catalog no.	H	W
DN1206RR5	1200	600
DN1405RR5	1400	500
DN1406RR5	1400	600
DN1606RR5	1600	600
DN1804RR5	1800	400
DN1805RR5	1800	500
DN1806RR5	1800	600
DN1808RR5	1800	800
DN1809RR5	1800	900
DN2004RR5	2000	400
DN2005RR5	2000	500
DN2006RR5	2000	600
DN2008RR5	2000	800
DN2009RR5	2000	900
DN2205RR5	2200	500
DN2206RR5	2200	600

All measurements in mm.

Left door of a double door enclosure

Catalog no.	H	W
DN1206LR5	1200	600
DN1405LR5	1400	500
DN1406LR5	1400	600
DN1606LR5	1600	600
DN1804LR5	1800	400
DN1805LR5	1800	500
DN1806LR5	1800	600
DN1808LR5	1800	800
DN1809LR5	1800	900
DN2004LR5	2000	400
DN2005LR5	2000	500
DN2006LR5	2000	600
DN2008LR5	2000	800
DN2009LR5	2000	900
DN2205LR5	2200	500
DN2206LR5	2200	600

All measurements in mm.



## Door hinges 180°, DHN

- Description:** Adjustable door hinges which allows the door to open 180°. Machining is required.
- Material:** Die-cast alloy.
- Finish:** Structured black.
- Maximum load:** 800 N (per kit).
- Pack quantity:** 4 hinges with mounting accessories.

Catalog no.
DHN180N



Scan QR code to watch an instructional video

## Door mounting kits, DNMK

- Description:** Door mounting kit for mild steel floor standing enclosures. Required when fitting a door. Only needed when there was no door mounted previously.
- Pack quantity:** 1 complete kit with hinges, rod catches and mounting accessories.

Catalog no.	Description
DNMK01	for single door enclosures
DNMK02	for double door enclosures



# Modular

## Accessories

### Inner doors, DI

- Description:** Inner door provides a hinged mounting surface for equipment behind a standard or glazed front door. A mounting space of 80 mm, is available between the doors when the inner door is in the most forward position. Can be adjusted in depth by steps of 25 mm. The mounting plate remains usable behind the inner door. The door is equipped with two double-bit 3 mm locks.
- Material:** 1.5 mm mild steel.
- Finish:** RAL 7035 structured powder coating.
- Pack quantity:** 1 door with mounting accessories.



Catalog no.	For enclosure	
	H	W
DI1406R5	1400	600
DI1408R5	1400	800
DI1606R5	1600	600
DI1608R5	1600	800
DI1806R5	1800	600
DI1808R5	1800	800
DI2006R5	2000	600
DI2008R5	2000	800
DI2206R5	2200	600
DI2208R5	2200	800

Other sizes available on request.  
All measurements in mm.

### Side doors, DNS

- Description:** Instead of the side panel SPM. For easy access to the equipment inside the enclosure or when enclosures are mounted rear to rear. Equipped with standard double-bit 3 mm lock which makes all lock options possible. Door frame optional.
- Material:** 2 mm steel plate.
- Finish:** RAL 7035 structured powder coating.
- Protection:** Complies with IP 55 | TYPE 12 | IK 10.
- Pack quantity:** 1 door including mounting frame.



Catalog no.	H	W
DNS1805R5	1800	500
DNS1806R5	1800	600
DNS2005R5	2000	500
DNS2006R5	2000	600

All measurements in mm.

## Door plastic support, DPSL

**Description:** Helps to center the door in case of an uneven floor, as well as allowing easier closing and positioning when a heavy load is mounted (cooling units, etc). Mounted directly to the door frame on the bottom and top of the door. Highly recommended when fitting loads from 30 kg on door.

**Pack quantity:** 2 plastic supports with mounting accessories.

Catalog no.
DPSL01



## Door stop, DSTP

**Description:** To lock an open door in position. Mounted directly to the door frame and on the enclosure profile. Allows the enclosure door to be opened up to 110°.

**Pack quantity:** 1 piece with mounting accessories.

Catalog no.	Material
DSTP02	Zinc plated



Scan QR code to watch an instructional video

# Modular

01

## Accessories

Modular Enclosures

### Door wheel, DW

**Description:** For easier closing and positioning of a heavily equipped door (cooling units, etc). Mounted directly to the door frame on the bottom of the door. Highly recommended when fitting loads from 30 kg on the enclosure door.

**Pack quantity:** 2 pieces with mounting accessories.

Catalog no.
DW01



02

03

### Document pockets, DRB

**Description:** A large steel document pocket fixed directly onto the door frame. Usable depth: 68 mm.

**Finish:** RAL 7035 structured powder coating.

**Pack quantity:** 1 piece with mounting accessories.

Catalog no.	Description	Material
DRB0303R5	Universal document pocket 300 mm wide	1.5 mm mild steel
DRB500R5	For 500 mm doors	1.5 mm mild steel
DRB600R5	For 600 mm doors	1.5 mm mild steel
DRB800R5	For 800 mm doors	1.5 mm mild steel

All measurements in mm.



## Door frame mounting profiles, DCP

**Description:** Horizontal profiles with 25 mm hole pattern. Fits directly onto the door frame. For easy mounting of light equipment by using CNT05 screws, hole pattern of 4.5 mm and 6.5 mm in diameter.

**Material:** 2 mm zinc plated steel.

**Pack quantity:** 20 bars with mounting accessories.

Catalog no.	W
DCP402	400
DCP502	500
DCP602	600
DCP802	800
DCP1002	1000

All measurements in mm.



## Drawing desks, DDK

**Description:** Mounted directly to the door frame it provides a solid surface for documents, computer or measuring devices. The desk can be easily folded and locked within the door frame space. An automatic safety positioning system locks the desk at angles of 55°, 70° and 90°. The DDK800R5 can also be mounted on a 1000 mm wide door, by the use of the DCP1002 accessory.

**Material:** 1.35 mm mild steel.

**Finish:** RAL 7035 structured powder coating.

**Pack quantity:** 1 piece with mounting accessories.

Catalog no.	W
DDK600R5	600
DDK800R5	800

All measurements in mm.



# Modular

## Accessories

### Door switch, DSW

- Description:** Door switch to activate any electrical device (lighting, signalling, alarms, etc.). Can be mounted after installing the enclosure thereby keeping the door opening free. Fixed on the inside hole pattern of the enclosure's frame in floor standing enclosures. Cable entry M20.
- Switch capacity:** 3 A/240 V.
- Approvals:** CE, cCSAus, CCC.
- Pack quantity:** 1 piece with mounting accessories.



Catalog no.
DSW01

### Universal keyboard trays, UKT

- Description:** Horizontal hinged keyboard tray with lateral sliding mouse pad (L.H. or R.H.). Equipped with panel stay. When the tray is folded out, the enclosure is sealed for dust ingress by a closed chamber.
- Material:** 1.75 mm steel plate.
- Finish:** RAL 7035 structured powder coating.
- Pack quantity:** 1 door with hinges, lock, keyboard mounting support, mouse pad and mounting accessories.



Catalog no.	H	W
UKT06R5	250	600
UKT08R5	250	800

All measurements in mm.

## Lift handle lock covers, LLH

- Description:** Lift handle for LHC locking inserts/half cylinders.
- Material:** Zamak.
- Pack quantity:** 1 lift handle.
- Mounting requirements:** Add LHC inserts/half cylinders when required.



Catalog no.	Description	Finish	Compatible inserts
LLH501N	Without padlocking	RAL 9005	LHC522 / LHC523 / LHC528 / LHC529 / LHC531 / LHC536
LLH502N	Without padlocking	RAL 9005	LLHC534 / LHC5212132E
LLH503N	With padlocking	RAL 9005	LHC522 / LHC523 / LHC524 / LHC526 / LHC527 / LHC528 / LHC529 / LHC530 / LHC536
LLH504N	With padlocking	RAL 9005	LHC534 / LHC5212132E



Scan QR code to watch an instructional video

# Modular

## Accessories

### Inserts, LI

**Description:** Inserts to replace the standard double-bit 3 mm insert in the standard lock cover.

**Material:** Zamak.

**Pack quantity:** 1 piece.



Catalog no.	Description
LI503	Double-bit 3 mm
LI505	Double-bit 5 mm
LI523	Square 7 mm
LI524	Square 8 mm
LI526	Triangular 7 mm
LI527	Triangular 8 mm
LI528	Slotted 2x4
LI530	Daimler Benz

All measurements in mm.

### Locking system for lift handles, LHC

**Description:** Profile half cylinder locks. To be used in the lift handles LLH.

**Pack quantity:** 1 piece.



Catalog no.	Description	Compatible handle
LHC521	Profile half cylinder Ronis key C21323	LLH502N / LLH504N
LHC522	Round cylinder Ronis key C21323	LLH501N / LLHS501N / LLH503N
LHC523	Square 7 mm	LLH501N / LLHS501N / LLH503N
LHC528	Double-bit 3 mm	LLH501N / LLHS501N / LLH503N
LHC529	Double-bit 5 mm	LLH501N / LLHS501N / LLH503N
LHC531	Lock insert slotted 2x4 mm	LLH502N / LLH504N
LHC534	Adapter for other profile half cylinders (DIN18252)	LLH502N / LLH504N
LHC536	Push button only	LLH501N / LLHS501N / LLH503N
LHC5212132E	Profile half cylinder Ronis key 2132E	LLH502N / LLH504N

\* Other key numbers available on request.  
 \*\* Key numbers 333, 1333, EK333 and GX130 are equal.  
 \*\*\* Order separate key LSMK for Square 8 mm and Triangle 8 mm.

All measurements in mm.

## Lift handle lock covers, LLHS

- Description:** Lift handle for LHC locking inserts/half cylinders. To be used with stainless steel combinable enclosures.
- Material:** Zamak.
- Pack quantity:** 1 lift handle.
- Mounting requirements:** Add LHC inserts/half cylinders when required.



Catalog no.	Description	Finish	Compatible inserts
LLHS501N	Without padlocking	Chrome	LHC522 / LHC523 / LHC528 / LHC529 / LHC531 / LHC536



Scan QR code to watch an instructional video

# Modular

## Accessories

### System actuator, FMA

- Description:** Used with suited multiple enclosure installations. Activates the locking of the secondary doors when the main door is closed. One per main door.
- Material:** Zinc plated steel.
- Pack quantity:** 1 piece with mounting material.

Catalog no.
FMA01



### Main door interlock kit, FMD

- Description:** Locks or releases the main door after the power has been switched. Universal adapter permits all popular manufacturers variable depth actuators without modification.
- Material:** Zinc plated steel.
- Pack quantity:** 1 piece with mounting material.

Catalog no.
FMD01



## Interlock bars, FMB

**Description:** For combinable enclosures. Interlock rods mechanically link all secondary doors to the main door. Rod length corresponds to enclosure door width.

**Material:** Zinc plated steel.

**Pack quantity:** 5 pieces with mounting material.

Catalog no.	W
FMB600	600
FMB800	800
FMB1000	1000
FMB1200	1200

All measurements in mm.



## Secondary door interlock kit, FMS

**Description:** Mounted to the secondary door of both single and double door enclosures. Secondary door is prevented from opening when main door is closed. This safety feature can be activated separately even when the main door interlocking device is not installed. One set per secondary door is needed.

**Material:** Zinc plated steel.

**Pack quantity:** 1 set with mounting material.

Catalog no.
FMS01



# Modular

## Accessories

### Side panels, SPM

- Description:** Easy one-person assembly. Sealed by an extruded, one piece polyurethane gasket and mounted with 8 screws. Can be replaced by the side door DS.
- Material:** 1.5 mm steel plate.
- Finish:** RAL 7035 structured powder coating.
- Protection:** IP 55 | TYPE 12, 13 in combination with MCS. IP66 | TYPE 4, 12, 13 in combination with MCS-HP.
- Pack quantity:** 2 panels with mounting accessories.

Catalog no.	For enclosure	
	H	D
SPM1106R5	1100	600
SPM1205R5	1200	500
SPM1405R5	1400	500
SPM1406R5	1400	600
SPM1605R5	1600	500
SPM1606R5	1600	600
SPM1804R5	1800	400
SPM1805R5	1800	500
SPM1806R5	1800	600
SPM1808R5	1800	800
SPM2004R5	2000	400
SPM2005R5	2000	500
SPM2006R5	2000	600
SPM2008R5	2000	800
SPM2010R5	2000	1000
SPM2206R5	2200	600
SPM2208R5	2200	800
SPM2205R5	2200	500
SPM2210R5	2200	1000

All measurements in mm.

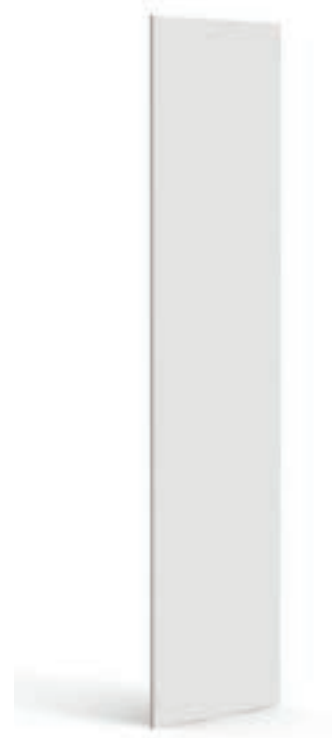

Scan QR code to watch an instructional video

## Side panels, stainless steel, SPMS

- Description:** Easy one-person assembly. Sealed by an extruded, one piece polyurethane gasket and mounted with 8 screws.
- Material:** 1.5 mm AISI 304 / AISI 316L pre-grained stainless steel.
- Finish:** 400 pre-grained stainless steel.
- Protection:** IP 55 | TYPE 12, 13 in combination with MCSS. IP66 | TYPE 4X, 12, 13 in combination with MCSS-HP.
- Pack quantity:** 2 panels with mounting accessories.

Catalog no.	For enclosure	
	H	W
SPMS1805	1800	500
SPMS2006	2000	600

All measurements in mm.



Scan QR code to watch an instructional video

## Internal baying brackets, CCI

- Description:** Quick fixation baying brackets provide a rigid reinforcement of the enclosure assembly. The correct spacing between the enclosures is assured. Tools are not required for installation.
- Material:** 3 mm zinc plated steel.
- Pack quantity:** 6 brackets with mounting accessories.

Catalog no.
CCI06



Scan QR code to watch an instructional video

# Modular

## Accessories

### Internal baying brackets, CCTV

- Description:** Brackets that enable baying of modular enclosures, MCS/MCD, with the previous generation of enclosures from another leading brand in the market.
- Material:** 3 mm zinc plated steel.
- Pack quantity:** 6 brackets with mounting accessories.

Catalog no.
CCTV06

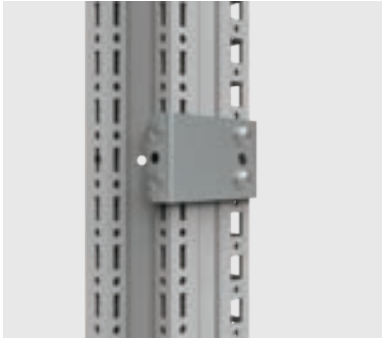

### External baying brackets, CCE

- Description:** Brackets mounted on the outside hole pattern of the frame ensuring a strong and 3 dimensional alignment of the mild steel bayed enclosures with an "auto spacer" function. This method of baying enclosures also has the advantage of creating a direct earthing connection between the enclosure frames.
- Material:** 3 mm zinc plated steel.
- Pack quantity:** 6 brackets with mounting accessories.

Catalog no.
CCE06



Scan QR code to watch an instructional video

### Internal corner baying kit, CCM

- Description:** For extra support when bayed enclosures are fully equipped and require lifting. Can be used together with SPD separation plates.
- Material:** 3 mm zinc plated steel.
- Pack quantity:** 4 brackets with mounting accessories.

Catalog no.
CCM04

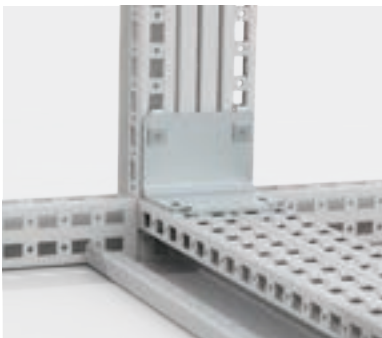

## Short external baying brackets, CCEH

**Description:** Short brackets mounted on the outside hole pattern of the frame of the bayed enclosures with an "auto spacer" function. Specially designed for small doors/panels configuration. This method of baying mild steel enclosures has also the advantage of creating a direct earthing connection between the enclosure frames.

**Material:** 3 mm zinc plated steel.

**Pack quantity:** 6 brackets with mounthing material.



Catalog no.
CCEH06



Scan QR code to watch an instructional video

## Depth baying kit, CJDN

**Description:** For baying enclosures rear to rear.

**Material:** Covers: 2 mm mild steel. Brackets: 3 mm zinc plated steel.

**Finish:** RAL 7035.

**Protection:** IP 55

**Pack quantity:** 1 kit with mounting accessories.



Catalog no.	For enclosure	
	H	W
CJDN1806R5	1800	600
CJDN1808R5	1800	800
CJDN1810R5	1800	1000
CJDN2006R5	2000	600
CJDN2008R5	2000	800
CJDN2010R5	2000	1000
CJDN2206R5	2200	600
CJDN2208R5	2200	800

All measurements in mm.

# Modular

## Accessories

Modular Enclosures

### Separation plates for MCS and MCD enclosures, SPD

- Description:** Separates two bayed MCS/MCD enclosures.
- Material:** 1.5 mm zinc plated steel.
- Mounting requirements:** IP 43 | TYPE 1 sealing can be obtained by using SPDG gasket. CCJ brackets are required to mount the SPD into the enclosures. To bay enclosures together, use CCM and CCI brackets. For EMI shielding the SPDEG gasket must be used.
- Pack quantity:** 1 piece.



Catalog no.	For enclosure	
	H	D
SPD1804	1800	400
SPD1805	1800	500
SPD1806	1800	600
SPD2004	2000	400
SPD2005	2000	500
SPD2006	2000	600
SPD2008	2000	800
SPD2206	2200	600
SPD2208	2200	800

All measurements in mm.



Scan QR code to watch an instructional video

### Separation plate gasket, SPDG

- Description:** To obtain IP 43 | TYPE 1 sealing in combination with the separation plate SPD/SPDS.
- Material:** Neoprene 5x15/20.
- Pack quantity:** 6 m.

Catalog no.
SPDG01



## Separation plate brackets, CCJ

- Description:** Mounted to the enclosure's frame. Can be used on both vertical and the horizontal profiles.
- Material:** 3 mm zinc plated steel.
- Pack quantity:** 6 brackets with mounting accessories.

Catalog no.
CCJ06



## Baying gasket for IP66, HPPG01

- Description:** To obtain IP66 | Type 4 (4X), 12, 13 sealing in bayed configuration of MCS-HP/MCSS-HP in combination with CCI06 and CCM04.
- Material:** EPDM, 5 mm thickness.
- Pack quantity:** 1 pad compatible with all enclosure dimensions.

Catalog no.
HPPG01



# Modular

## Accessories

### Lifting eye bolts, LE

- Description:** Mounts directly to the frame corner pieces of the enclosure for when lifting operations are required. Complies with DIN 580 lifting requirements. M12 thread.
- Maximum load:** 3400N per lifting eye with max angle of 45°. Please refer to Loading and Lifting White Paper for more details.
- Pack quantity:** 4 pieces.

Catalog no.	Material
LE9304	Zinc plated
LE9304SS	Stainless steel 304



Scan QR code to watch an instructional video

### Lifting devices, LC

- Description:** For optimal weight distribution when lifting bayed enclosures. To be used in combination with baying bracket.
- Pack quantity:** 2 pieces with mounting accessories.

Catalog no.	Material
LC02	Zinc plated
LC02-316	Stainless steel 316L

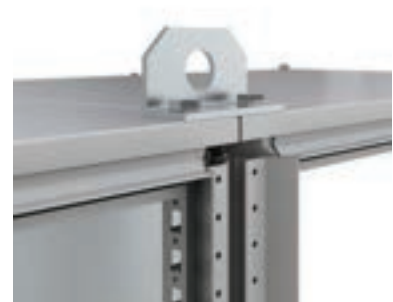

Scan QR code to watch an instructional video

## Ventilation roofs, CVR

- Description:** Raised roof with 2.5 mm ventilation slots and filter material.
- Material:** 1.5 mm steel plate. Filter material: EU 4 according to DIN 24185.
- Finish:** RAL 7035 structured powder coating.
- Temperature resistance:** 100°C.
- Protection:** Complies with IP 31 | TYPE 1.
- Pack quantity:** 1 piece with mounting brackets and ventilation filter.
- Note:** Increases the enclosure height by 40 mm.



Catalog no.	For enclosure	
	W	D
CVR0505R5	500	500
CVR0603R5	600	300
CVR0604R5	600	400
CVR0605R5	600	500
CVR0606R5	600	600
CVR0608R5	600	800
CVR0803R5	800	300
CVR0804R5	800	400
CVR0805R5	800	500
CVR0806R5	800	600
CVR0808R5	800	800
CVR0809R5	800	900
CVR1004R5	1000	400
CVR1005R5	1000	500
CVR1006R5	1000	600
CVR1008R5	1000	800
CVR1203R5	1200	300
CVR1204R5	1200	400
CVR1205R5	1200	500
CVR1206R5	1200	600
CVR1208R5	1200	800
CVR1604R5	1600	400
CVR1605R5	1600	500
CVR1606R5	1600	600

All measurements in mm.

# Modular

## Accessories

### Fan roof plates, CFR

- Description:** For mounting a combination of 6 fans DFN or closing plates DFC for unused holes in the top of the enclosure.
- Material:** 2 mm zinc plated steel.
- Mounting requirements:** Add Ventilation roof CVR. Use fan DFN. Unused holes should be closed with DFC.
- Pack quantity:** 1 piece with mounting accessories.

Catalog no.	W	D	N° of cut outs
CFR0606	600	600	6
CFR0608	600	800	6
CFR0806	800	600	6
CFR0808	800	800	6

All measurements in mm.



### Ventilation fans, DFN

- Description:** Two ventilation fan versions: DFN01 for mounting to a surface from below, DFN02 for mounting on top of a surface, with flow always pointing upwards. Extra contact provided for thermostat connection.
- Voltage:** 220–240 VAC.
- Air circulation:** 160 m³/h.
- Power of the fan:** 19 Watt.
- Pack quantity:** 1 set with finger guards and mounting screws.
- Note:** For easy connection use wiring kit DFN61.

Catalog no.	Description
DFN01	Inside mounting
DFN02	Top mounting

When ventilator holes are not used they can be closed with DFC closing plates.



## Wiring kit, DFN61

- Description:** Wiring kit for a maximum connection of 6 fans (DFN) and 1 thermostat/hygrostat (ETR/ETF). The thermostat or hygrostat can be connected through the separate terminal mounted on the side.
- Pack quantity:** 1 set containing: |- 1 DIN rail 15 cm |- 1 L- connector block |- 1 N-connector block |- 1 PE-connector block |- 1 Free terminal |- 1 Power cable with Schuko/UTE plug, 2,5 m |- 6 Pieces blue connection cables 81 cm |- 6 Pieces black connection cables 81 cm |- 6 Pieces green/yellow earthing cables 81 cm |- 6 Pieces self adhesive cable feet |- 8 Mounting screws.



Catalog no.
DFN61

## Closing plates, DFC

- Description:** Closing plate for an unused fan (DFN) opening.
- Material:** 1.5 mm zinc plated steel.
- Pack quantity:** 4 piece with mounting accessories.



Catalog no.
DFC04

# Modular

## Accessories

Modular Enclosures

### Ventilated bottom plates, CVB

- Description:** Can be used in combination with a ventilated plinth PV. 33% ventilated.
- Material:** 1.5 mm perforated zinc plated steel.
- Pack quantity:** 3 pieces, 4 pieces for D>600mm, with mounting material.
- Mounting requirements:** Use in combination with ventilated plinths PV.

Catalog no.	For enclosure	
	W	D
CVB0604	600	400
CVB0605	600	500
CVB0606	600	600
CVB0608	600	800
CVB0804	800	400
CVB0805	800	500
CVB0806	800	600
CVB0808	800	800
CVB1004	1000	400
CVB1005	1000	500
CVB1006	1000	600
CVB1008	1000	800
CVB1206	1200	600
CVB1208	1200	800

All measurements in mm.

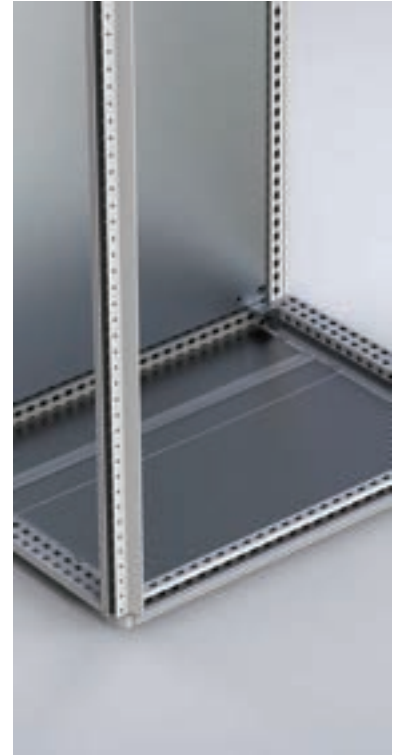

### Spacer kits, CVK

- Description:** Provides ventilation by raising the enclosure's roof panel 15 mm (CVK15), 50 mm (CVK50).
- Material:** Zinc plated steel.
- Pack quantity:** 4 pieces with mounting accessories.

Catalog no.	Description
CVK15	Raises the roof 15 mm
CVK50	Raises the roof 50 mm

All measurements in mm.



## Section profiles for cable entry, SCE

- Description:** For sealing the cable entry between gland plates. Forms a tight seal around cables and fills gaps to prevent dust from entering. The foam is pre-fitted in the section profile that can be easily mounted in the bottom plates thanks to its click-in fixing solution. An alternative to the bottom plate gasket kit BG01.
- Material:** Extruded PVC section profile. Gasket: adhesive foam with cross-section of 30 x 25 mm.
- Pack quantity:** 1 set consisting of 2 click-in section profiles with foam rubber.

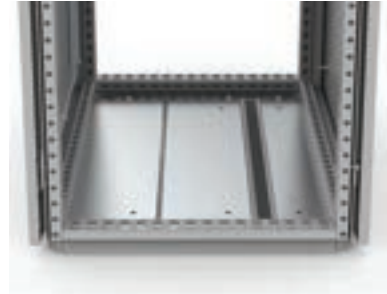

	For enclosure
Catalog no.	W
SCE600	600
SCE800	800
SCE1000	1000
SCE1200	1200

All measurements in mm.

## Inside cable fixing bars, CAB

- Description:** Mounted above the bottom plates. Holds standard cable clamps CAC to secure incoming cables. Fully adjustable in depth. When EMC shielded earthing cables are connected to the support bar the Faraday effect will be kept intact for maximum EMI shielding.
- Material:** 2 mm zinc plated steel.
- Pack quantity:** 2 bars with mounting accessories.
- Mounting requirements:** Add CAC clamps depending on diameter of the cable(s).



	For enclosure
Catalog no.	W
CAB600	600
CAB800	800
CAB1000	1000
CAB1200	1200

All measurements in mm.

# Modular

## Accessories

### Cable entry foam and bottom plate gaskets, BG

**Description:** The bottom of the enclosure is sealed by the use of an adhesive gasket applied on to the frame around the openings at the bottom of the enclosure. The cables are sealed by the addition of adhesive foam placed between the bottom plates. The elasticity and the size of this foam ensures a tight seal around most cables.

**Pack quantity:** 1.6 m adhesive foam (30 x 25 mm) and 6 m adhesive gasket (4.5 x 8 mm). For 1600 mm wide enclosures please order 2 sets.



Catalog no.
BG01

### Cable clamps, CAC

**Description:** To secure incoming cables onto the fixing bars CAB and CABP. Holds the cable in position and supports the weight.

**Material:** Zinc plated steel.

**Pack quantity:** 25 clamps.

**Mounting requirements:** Add CAB/CABP to mount the cable clamps CAC.



Catalog no.	Size/Cable amount
CAC0612	06-12
CAC1014	10-14
CAC1216	12-16
CAC1418	14-18
CAC1822	18-22
CAC2226	22-26
CAC2630	26-30
CAC3034	30-34
CAC3438	34-38
CAC3842	38-42
CAC4246	42-46
CAC5864	58-64

All measurements in mm.

## Raised side doors, DNSR

- Description:** A 200 mm wide cover with cable entrances in top and bottom. Supplied with one gland plate and gasket. Hole pattern equals enclosure's frame to mount cable fixing bars.
- Material:** 2 mm.
- Finish:** RAL 7035 structured powder coating.
- Protection:** Complies with IP 33 | TYPE 1 in combination with MM connector plate and gasket SPDG01. Door frame optional.
- Mounting requirements:** Add a separation plate SPD or marshalling plate MM to mount connectors and separate the side compartment.
- Pack quantity:** 1 piece with mounting accessories.



Catalog no.	For enclosure	
	H	D
DNSR2006R5	2000	600

All measurements in mm.

## Cover plates, MMG

- Description:** To cover unused connector cut-outs of a marshalling plate MM, or to adapt to 16 pins connectors to allow the mix of both connector types.
- Material:** 2 mm zinc plated steel.
- Pack quantity:** For quantity see table. Including mounting accessories and seal.

Catalog no.	Description	Size	Pack quantity
MMG16	Cover plate	16 pin	20

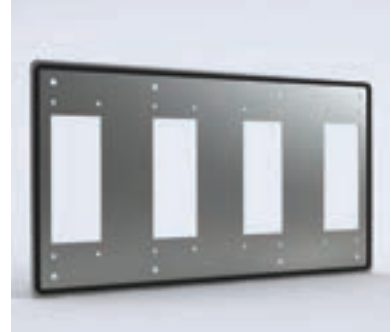

# Modular

## Accessories

### Earthing cables, ECFA

- Description:** For earthing between metallic parts.
- Material:** 6 mm<sup>2</sup> copper wire (yellow-green).
- Pack quantity:** 10 pieces.
- Mounting requirements:** Add connection set ECF for fixing cable to painted frame.

Catalog no.	Length	Connection size
ECFA220	220 mm	M6 / M8
ECFA300	300 mm	M8 / M8

All measurements in mm.



Scan QR code to watch an instructional video

### Earthing straps, ECFE

- Description:** For earthing and potential compensation between panels, parts and the enclosure's frame.
- Length:** 300 mm.
- Material:** Tinned electrolytic copper 0.15 mm wire.
- Working temperature:** Up to 105°C.
- Pack quantity:** 10 pieces.
- Mounting requirements:** Add ECF connection set for fixing strap to painted frame.

Catalog no.	Cross sectional area	Holes diam.	Current (A)
ECFE1630	16 mm <sup>2</sup>	8.5	120 A
ECFE2530	25 mm <sup>2</sup>	10.5	150 A

All measurements in mm.



Scan QR code to watch an instructional video

## Earthing connections for frames, ECF

**Description:** Earthing connections for fixing the earthing straps and cables to the enclosure's frame.

**Pack quantity:** 10 sets.

Catalog no.	Bolt size
ECF06	M6
ECF06S	M6
ECF08	M8



## Central earthing point, ECFP

**Description:** Provides earthing contact surface on horizontal or vertical frame profiles for a secure earthing point with multiple connections

**Material:** Galvanized steel.

**Pack quantity:** 3 central earthing points with mounting accessories. M8 earthing kit included for the three holes.

Catalog no.
ECFP08

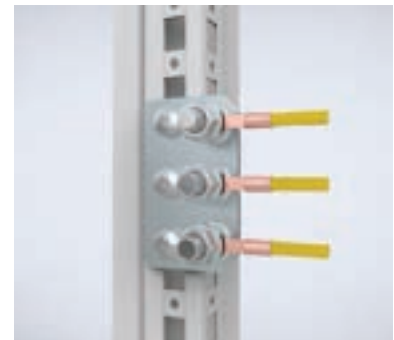

## Earthing connection for panels, ECP

**Description:** Earthing connection for fixing the earthing straps and cables to panels, mounting plates or profiles.

**Pack quantity:** 10 sets.

Catalog no.	Bolt size
ECP06	M6
ECP08	M8



## Wall Mounted Enclosures

|||

01

02

Wall Mounted Enclosures

03



**10 MINUTES  
SAVED**

for each wall mounted enclosure  
with the below accessories

**1** x MOUNTING PLATE

**3** x 180° HINGES

**+** x PROFILES



### FAST ASSEMBLY



Mounting  
plate

Machining free  
180° hinges

Profiles

### OPTIMUM PROTECTION



Door positioning  
for large enclosures

Low water  
absorption  
gasket



01

02

Wall Mounted Enclosures

03

## APPEALING DESIGN



Silicone gasket for 316 stainless steel enclosures



Lock cover

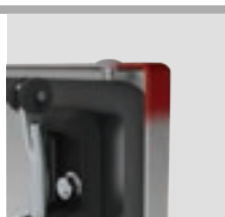

Door corner forming stainless steel



**Wall Mounted  
Mild Steel**

**01**

Single door | MAS

**02**

IP 66 | TYPE 4, 12 | IK 10

Wall Mounted Enclosures

**03**



**Material:**

Body: 1.2 mm mild steel for enclosures with a depth of 155 mm / 1.4 mm for enclosures with a depth of 210 or 260 mm / 1.5 mm for enclosures with a depth of 300 or 400 mm, or if a height or width is 1000 mm or greater. Gland plate: 1.4 mm mild steel. Door: 1.2 mm mild steel / 1.5 mm for enclosures with a height or width of 500 mm or greater / 2 mm for enclosures with a height or width of 800 mm or greater. Mounting plate: 2 mm galvanized steel.

**Body:**

Folded and seam welded. Four 8.5 mm diameter holes for wall fixing, pressed out in 20.4 mm diameter x 2 mm depressions, to allow air circulation around the rear part of the enclosure.

**Door:**

Surface mounted with 130° opening. Concealed removable hinges with captive pin. Hinges can be mounted to allow left or right hand opening. Inner M6 welded studs to mount door profiles MMDP. Sealing is ensured by an injected one piece polyurethane gasket.

**Lock:**

Customized lock with double-bit for easy opening of the door. Double-bit 3 mm insert and 90° movement. 1000 mm high enclosures and above have 3-point espagnolette locking. Other inserts are available as an accessory.

**Mounting plate:**

The mounting plate is marked vertically at 10 mm intervals, for easy horizontal positioning of equipment. On the top and bottom there are holes to facilitate cable fixing. Fixed onto M8 press welded studs to the rear of the enclosure. All sides, from 800 mm and above, are strengthened by folded edges. By using the AMG accessory, the mounting plate position can be adjusted to any depth.

**Gland Plate Opening:**

Situated at the far rear of the enclosure, to make cabling onto the mounting plate easier.

**Protection:**

Complies with IP 66 | TYPE 4, 12 | IK 10. For outdoor installation, the use of a rain hood ARF and 100% polyester paint coating is recommended. The corrosion resistance must be taken into consideration.

**Finish:**

RAL 7035 structured powder coating.

**Delivery:**

Enclosure with door. For height 600 mm and above, two door mounting profiles. Gland plate(s) with gasket(s), plastic double-bit 3 mm key, and mounting accessories. Metallic key, for height 1000 mm and above. Earthing facilities.



# Dimensional table | MAS

IP 66 | TYPE 4, 12 | IK 10

With mounting plate

Catalog no.	Enclosure dimensions			Size	Gland plate		N° of locks
	H	W	D		Type	Openings	
MAS0202015R5	200	200	155	110 × 56	0S	1	1
MAS0252015R5	250	200	155	110 × 56	0S	1	1
MAS0252515R5	250	250	155	110 × 56	0S	1	1
MAS0302515R5	300	250	155	110 × 56	0S	1	1
MAS0302521R5	300	250	210	110 × 56	0S	1	1
MAS0303015R5	300	300	155	210 × 56	1S	1	1
MAS0303021R5	300	300	210	210 × 96	1	1	1
MAS0304021R5	300	400	210	310 × 96	2	1	1
MAS0352515R5	350	250	155	110 × 56	0S	1	1
MAS0403015R5	400	300	155	210 × 56	1S	1	1
MAS0403021R5	400	300	210	210 × 96	1	1	1
MAS0404021R5	400	400	210	310 × 96	2	1	1
MAS0405021R5	400	500	210	410 × 96	3	1	1
MAS0406021R5	400	600	210	510 × 96	4	1	1
MAS0406040R5	400	600	400	510 × 96	4	1	1
MAS0503021R5	500	300	210	210 × 96	1	1	1
MAS0504015R5	500	400	155	310 × 56	2S	1	1
MAS0504021R5	500	400	210	310 × 96	2	1	1
MAS0504026R5	500	400	260	310 × 96	2	1	1
MAS0504030R5	500	400	300	310 × 96	2	1	1
MAS0505021R5	500	500	210	410 × 96	3	1	1
MAS0505030R5	500	500	300	410 × 96	3	1	1
MAS0604015R5	600	400	155	310 × 56	2S	1	2
MAS0604021R5	600	400	210	310 × 96	2	1	2
MAS0604026R5	600	400	260	310 × 96	2	1	2
MAS0604030R5	600	400	300	310 × 96	2	1	2
MAS0604040R5	600	400	400	310 × 96	2	1	2
MAS0605015R5	600	500	155	410 × 56	3S	1	2
MAS0605021R5	600	500	210	410 × 96	3	1	2
MAS0605026R5	600	500	260	410 × 96	3	1	2

\* 1000 mm high enclosures and above have 3-point espagnolette locking.

All measurements in mm.



# Dimensional table | MAS

IP 66 | TYPE 4, 12 | IK 10

With mounting plate

Catalog no.	Enclosure dimensions			Gland plate			N° of locks
	H	W	D	Size	Type	Openings	
MAS0605030R5	600	500	300	410 × 96	3	1	2
MAS0606021R5	600	600	210	510 × 96	4	1	2
MAS0606030R5	600	600	300	510 × 96	4	1	2
MAS0606040R5	600	600	400	510 × 96	4	1	2
MAS0606026R5	600	600	260	510 × 96	4	1	2
MAS0608030R5	600	800	300	310 × 96	2	2	2
MAS0705021R5	700	500	210	410 × 96	3	1	2
MAS0705026R5	700	500	260	410 × 96	3	1	2
MAS0252015PER5	250	200	155	110 × 56	0S	1	1
MAS0252515PER5	250	250	155	110 × 56	0S	1	1
MAS0302515PER5	300	250	155	110 × 56	0S	1	1
MAS0302521PER5	300	250	210	110 × 56	0S	1	1
MAS0303015PER5	300	300	155	210 × 56	1S	1	1
MAS0303021PER5	300	300	210	210 × 96	1	1	1
MAS0304021PER5	300	400	210	310 × 96	2	1	1
MAS0352515PER5	350	250	155	110 × 56	0S	1	1
MAS0403015PER5	400	300	155	210 × 56	1S	1	1
MAS0403021PER5	400	300	210	210 × 96	1	1	1
MAS0404021PER5	400	400	210	310 × 96	2	1	1
MAS0405021PER5	400	500	210	410 × 96	3	1	1
MAS0406021PER5	400	600	210	510 × 96	4	1	1
MAS0503021PER5	500	300	210	210 × 96	1	1	1
MAS0504015PER5	500	400	155	310 × 56	2S	1	1
MAS0504021PER5	500	400	210	310 × 96	2	1	1
MAS0504026PER5	500	400	260	310 × 96	2	1	1
MAS0504030PER5	500	400	300	310 × 96	2	1	1
MAS0804030R5	800	400	300	310 × 96	2	1	2
MAS0806021R5	800	600	210	510 × 96	4	1	2
MAS0806026R5	800	600	260	510 × 96	4	1	2
MAS0806030R5	800	600	300	510 × 96	4	1	2

\* 1000 mm high enclosures and above have 3-point espagnolette locking.

All measurements in mm.

|||

01

02

Wall Mounted Enclosures

03

# Dimensional table | MAS

Without mounting plate

Catalog no.	Enclosure dimensions			Gland plate			N° of locks
	H	W	D	Size	Type	Openings	
MAS0202015PER5	200	200	155	110 × 56	0S	1	1
MAS0505021PER5	500	500	210	410 × 96	3	1	1
MAS0505030PER5	500	500	300	410 × 96	3	1	1
MAS0604015PER5	600	400	155	310 × 56	2S	1	2
MAS0604021PER5	600	400	210	310 × 96	2	1	2
MAS0604026PER5	600	400	260	310 × 96	2	1	2
MAS0604030PER5	600	400	300	310 × 96	2	1	2
MAS0605015PER5	600	500	155	410 × 56	3S	1	2
MAS0605021PER5	600	500	210	410 × 96	3	1	2
MAS0605026PER5	600	500	260	410 × 96	3	1	2
MAS0605030PER5	600	500	300	410 × 96	3	1	2
MAS0606021PER5	600	600	210	510 × 96	4	1	2
MAS0606030PER5	600	600	300	510 × 96	4	1	2
MAS0606040PER5	600	600	400	510 × 96	4	1	2
MAS0608030PER5	600	800	300	310 × 96	2	2	2
MAS0705021PER5	700	500	210	410 × 96	3	1	2
MAS0705026PER5	700	500	260	410 × 96	3	1	2
MAS0804030PER5	800	400	300	310 × 96	2	1	2
MAS0806021PER5	800	600	210	510 × 96	4	1	2
MAS0806026PER5	800	600	260	510 × 96	4	1	2
MAS0806030PER5	800	600	300	510 × 96	4	1	2
MAS0806040PER5	800	600	400	510 × 96	4	1	2
MAS0808021PER5	800	800	210	310 × 96	2	2	2
MAS0808030PER5	800	800	300	310 × 96	2	2	2
MAS0808040PER5	800	800	400	310 × 96	2	2	2
MAS1006026PER5	1000	600	260	510 × 96	4	1	1*
MAS1006030PER5	1000	600	300	510 × 96	4	1	1*
MAS1008026PER5	1000	800	260	310 × 96	2	2	1*
MAS1008030PER5	1000	800	300	310 × 96	2	2	1*
MAS1008040PER5	1000	800	400	310 × 96	2	2	1*
MAS1206030PER5	1200	600	300	510 × 96	4	1	1*
MAS1208030PER5	1200	800	300	310 × 96	2	2	1*
MAS1208040PER5	1200	800	400	310 × 96	2	2	1*

\* 1000 mm high enclosures and above have 3-point espagnolette locking.

All measurements in mm.

# Dimensional drawing | MAS

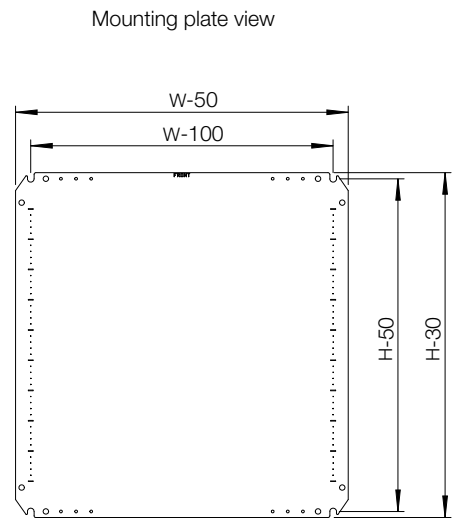
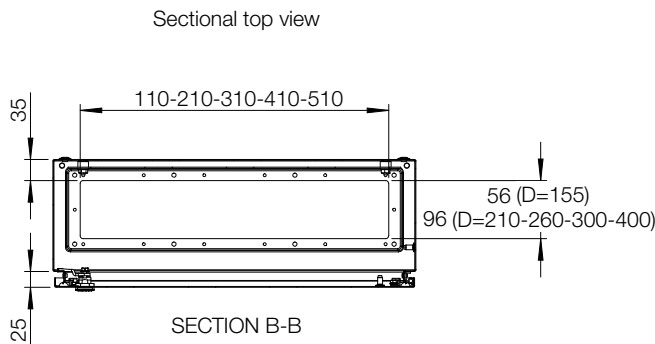
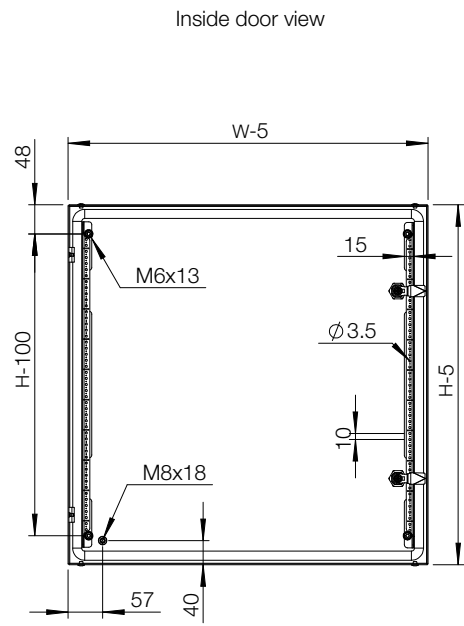
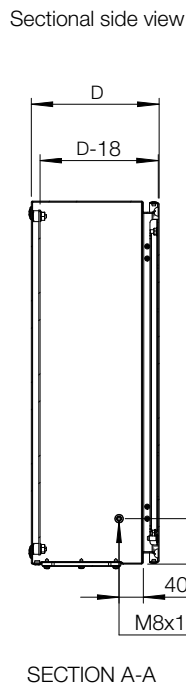
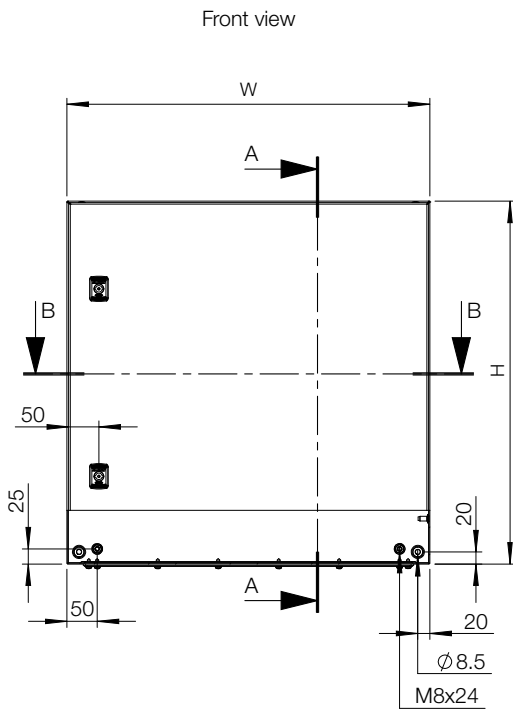



# Wall Mounted Mild Steel

01

Double door | MAD

02

IP 55 | TYPE 12 | IK 10

Wall Mounted Enclosures

03



**Material:**

Body: 1.5 mm mild steel. Gland plate: 1.4 mm mild steel. Door: 2 mm mild steel  
Mounting plate: 2 mm galvanized steel / 2.5 mm MAD1001030R5 and above.

**Body:**

Folded and seam welded. Four 8.5 mm diameter holes for wall fixing, pressed out in 20.4 mm diameter × 2 mm depressions, to allow air circulation around the rear part of the enclosure.

**Door:**

Surface mounted with 130° opening. Concealed removable hinges with captive pin. Inner M6 welded studs to mount door profiles MMDP. Two removable mounting profiles on the right hand door and two on the left hand door. Sealing is ensured by an injected one piece polyurethane gasket.

**Lock:**

Customized lock with double-bit for easy opening of the door. Double-bit 3 mm insert and 90° movement. 3-point espagnolette locking. Other inserts are available as an accessory.

**Mounting plate:**

The mounting plate is marked vertically at 10 mm intervals, for easy horizontal positioning of equipment. On the top and bottom there are holes to facilitate cable fixing. Fixed onto M8 press welded studs to the rear of the enclosure. All sides, from 800 mm and above, are strengthened by folded edges. By using the AMG accessory, the mounting plate position can be adjusted to any depth.

**Gland Plate Opening:**

Situated at the far rear of the enclosure, to make cabling onto the mounting plate easier.

**Protection:**

IP 55 | TYPE 12 | IK 10. For outdoor installation, the use of a rain hood ARF and 100% polyester paint coating is recommended. The corrosion resistance must be taken into consideration.

**Finish:**

RAL 7035 structured powder coating.

**Delivery:**

Enclosure with doors, and two door mounting profiles on the right door. Gland plate(s) with gasket(s), metallic double-bit 3 mm key, and mounting accessories. Earthing facilities.



## Dimensional table | MAD

### IP 55 | TYPE 12 | IK 10

With mounting plate

Catalog no.	Enclosure dimensions			Mounting plate dimensions		Usable depth	Gland plate			N° of locks
	H	W	D	h	w		Size	Type	Openings	
MAD0608030R5	600	800	300	570	750	282	310 x 96	2	2	1*
MAD0801021R5	800	1000	210	770	950	192	410 x 96	3	2	1*
MAD0801030R5	800	1000	300	770	950	282	410 x 96	3	2	1*
MAD0801230R5	800	1200	300	770	1150	282	510 x 96	4	2	1*
MAD1001030R5	1000	1000	300	970	950	282	410 x 96	3	2	1*
MAD1201030R5	1200	1000	300	1170	950	282	410 x 96	3	2	1*
MAD1201040R5	1200	1000	400	1170	950	382	410 x 96	3	2	1*
MAD1201230R5	1200	1200	300	1170	1150	282	510 x 96	4	2	1*
MAD1201240R5	1200	1200	400	1170	1150	382	510 x 96	4	2	1*

All measurements in mm.

Without mounting plate

Catalog no.	Enclosure dimensions			Gland plate			N° of locks
	H	W	D	Size	Type	Openings	
MAD0608030PER5	600	800	300	310 x 96	2	2	1*
MAD0801230PER5	800	1200	300	510 x 96	4	2	1*
MAD1001030PER5	1000	1000	300	410 x 96	3	2	1*
MAD1201030PER5	1200	1000	300	410 x 96	3	2	1*
MAD1201230PER5	1200	1200	300	510 x 96	4	2	1*
MAD1201240PER5	1200	1200	400	510 x 96	4	2	1*

\* 3-point espagnolette locking.

All measurements in mm.

# Dimensional drawing | MAD

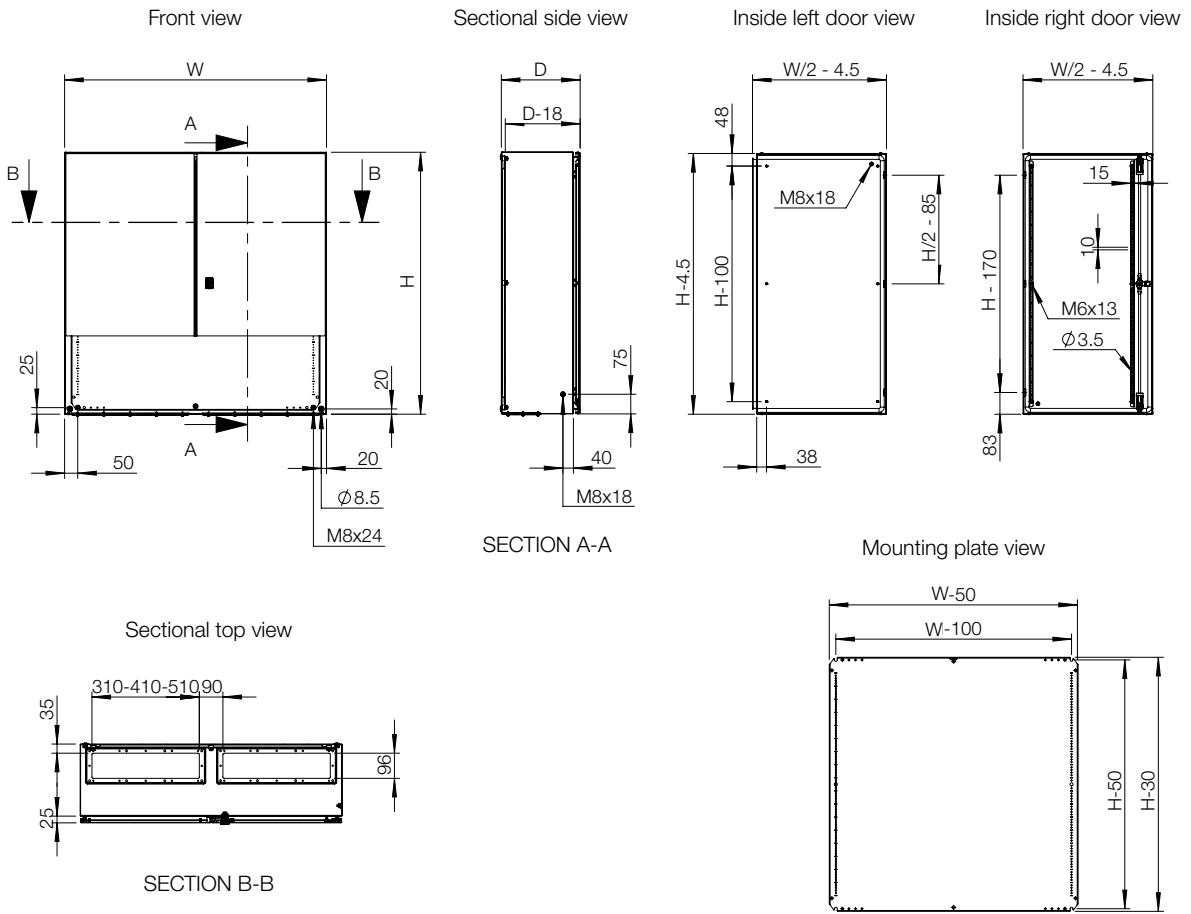



**Wall Mounted  
Stainless Steel**  
Single door | ASR

01

02

IP 66 | TYPE 4X, 12 | IK 10

Wall Mounted Enclosures

03



**Material:**

AISI 304 / AISI 316L pre-grained stainless steel. Body: 1.5 mm. Door for AISI 304: 1.5 mm / 2 mm for enclosures with a height or width of 600 mm or greater. Door for AISI 316L: 2 mm. Mounting plate: 2 mm galvanized steel.

**Body:**

Folded and seam welded.

**Door:**

Corner formed in one piece. Surface mounted, with 130° opening. Concealed AISI 304 stainless steel hinges with captive pin. Can be mounted to allow left or right hand opening. For AISI 316L, sealing is ensured by an injected one piece silicone gasket. Inner M6 welded studs, to mount door profiles MMDP.

**Lock:**

nVent customized zamak double-bit 3 mm lock, with 90° movement and anti-vibration mechanism. 1000 mm high enclosures and above have 3-point espagnolette locking. Stainless steel lock and other versions are available as accessories.

**Mounting plate:**

The mounting plate is marked vertically at 10 mm intervals, for easy horizontal positioning of equipment. On the top and bottom there are holes to facilitate cable fixing. Fixed onto M8 press welded studs to the rear of the enclosure. All sides, from 800 mm and above, are strengthened by folded edges. By using the AMG accessory, the mounting plate position can be adjusted to any depth.

**Cable access:**

No gland plate openings as standard, to maximise sealing and cleanliness.

**Protection:**

Corresponds with IP 66 | TYPE 4X, 12 | IK 10.

**Finish:**

400 pre-grained stainless steel.

**Delivery:**

Enclosure with door, mounting plate, plastic double-bit 3 mm key, and mounting accessories. Metallic key, for height 1000 mm and above.

**Additional information:**

For outdoor environments, exposed to precipitation, the use of a rain hood is advised. Also in environments known for quick temperature changes, consideration to condensation should be taken. Please see the thermal management section.

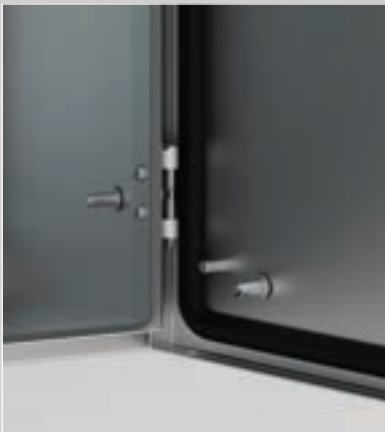

## Dimensional table | ASR

### IP 66 | TYPE 4X, 12 | IK 10

With mounting plate

Catalog no.	Enclosure dimensions			Mounting plate dimensions		Usable depth	N° of locks
	H	W	D	h	w	d	
ASR0242415	240	240	150	210	190	132	1
ASR0302015	300	200	150	270	150	132	1
ASR0403015	400	300	150	370	250	132	1
ASR0403021	400	300	210	370	250	192	1
ASR0403021-316	400	300	210	370	250	192	1
ASR0404021	400	400	210	370	350	192	1
ASR0406021	400	600	210	370	550	192	1
ASR0504021	500	400	210	470	350	192	1
ASR0505021	500	500	210	470	450	192	1
ASR0604021	600	400	210	570	350	192	2
ASR0604021-316	600	400	210	570	350	192	2
ASR0606021	600	600	210	570	550	192	2
ASR0606030	600	600	300	570	550	282	2
ASR0806021	800	600	210	770	550	192	2
ASR0806030	800	600	300	770	550	282	2
ASR0808030	800	800	300	770	750	282	2
ASR1008030	1000	800	300	970	750	282	1*
ASR1008030-316	1000	800	300	970	750	282	1*
ASR1208030	1200	800	300	1170	750	282	1*

\* 1000 mm high enclosures and above have 3-point espagnolette locking.

All measurements in mm.

# Dimensional drawing | ASR

Front view

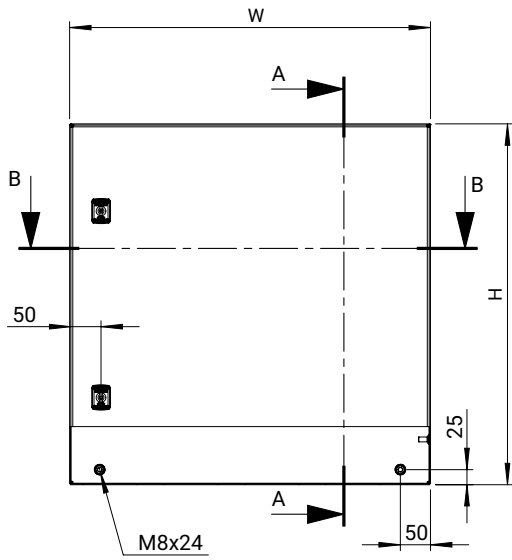

Sectional side view

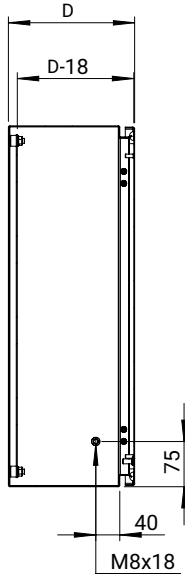

Inside door view

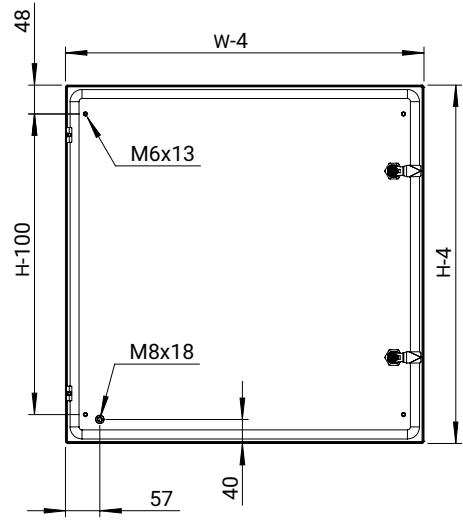

Sectional top view

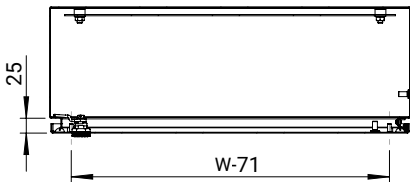

SECTION B-B

Mounting plate view

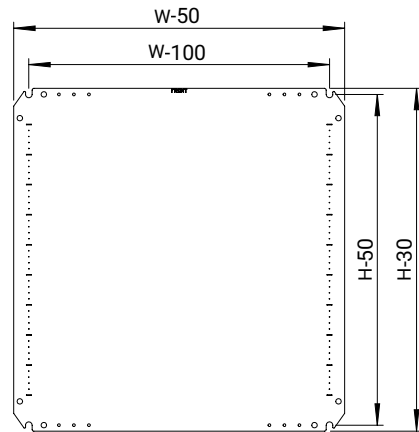

# Wall Mounted

## Accessories

### Mounting plates, AMP

**Description:** Steel mounting plate for wall mounted enclosures. All sizes from 800 mm and above are strengthened by folded edges. By using the AMG accessory, the mounting plate position can be adjusted to any depth. This accessory is not suitable for the AFS range of enclosures, please refer to the replacement and spare parts catalogue.

**Material:** Galvanized steel.

**Pack quantity:** 1 piece.



Catalog no.	For enclosure		Mounting plate dimensions	
	H	W	h	w
AMP01824	180	240	150	190
AMP02020	200	200	170	150
AMP02424	240	240	210	190
AMP02436	240	360	210	310
AMP02520	250	200	220	150
AMP02525	250	250	220	200
AMP03020	300	200	270	150
AMP03025	300	250	270	200
AMP03030	300	300	270	250
AMP03060	300	600	270	550
AMP03080	300	800	270	750
AMP03100	300	1000	270	950
AMP03120	300	1200	270	1150
AMP03525	350	250	320	200
AMP03624	360	240	330	190
AMP04030	400	300	370	250
AMP04040	400	400	370	350
AMP04050	400	500	370	450
AMP04060	400	600	370	550
AMP05030	500	300	470	250
AMP05040	500	400	470	350
AMP05050	500	500	470	450
AMP06040	600	400	570	350
AMP06050	600	500	570	450
AMP06060	600	600	570	550
AMP06080	600	800	570	750
AMP07050	700	500	670	450
AMP08040	800	400	770	350
AMP08060	800	600	770	550
AMP08080	800	800	770	750
AMP08100	800	1000	770	950
AMP08120	800	1200	770	1150
AMP10060	1000	600	970	550
AMP10080	1000	800	970	750
AMP10100	1000	1000	970	950
AMP10120	1000	1200	970	1150
AMP12060	1200	600	1170	550
AMP12080	1200	800	1170	750
AMP12100	1200	1000	1170	950
AMP12120	1200	1200	1170	1150
AMP14080	1400	800	1370	750
AMP14100	1400	1000	1370	950
AMP14120	1400	1200	1370	1150

*Not suitable for AFS.*  
All measurements in mm.

## Depth adjustment kit, AMG

- Description:** To provide depth adjustment for different accessories: mounting plate, 19" profiles and inner door. In stainless steel enclosures machining is required.
- Material:** 2 mm galvanized steel.
- Depth adjustment:** Distance to the door D-35 to 65 mm.
- Pack quantity:** 2 pairs with mounting accessories.



Catalog no.	For enclosure
	D
AMG155	155
AMG210	210
AMG260	260
AMG300	300
AMG400	400



Scan QR code to watch an instructional video

*Not suitable for AFS.*  
All measurements in mm.

# Wall Mounted

## Accessories

### Depth adjustment bolts, AMTE

**Description:** For depth adjustment of the mounting plate. Metric thread M8.

**Material:** Zinc plated steel.

Catalog no.	Length	Pack quantity
AMTE8010	10	50
AMTE8020	20	50
AMTE8030	30	50
AMTE8040	40	20
AMTE8050	50	20
AMTE8055	55	20
AMTE8100	100	20

All measurements in mm.



### Depth interior profile, DIP

**Description:** The DIP profile system is a 40 mm wide and 25 mm high profile, which can be mounted on the enclosure depth. It can also be used in combination with CLPF and CLPK profiles. Two rows of holes patterns for cage nut fixing and self-tapping screws are provided. DIP profiles are not compatible with adjustment in depth of the mounting plate.

**Material:** Zinc plated steel.

**Pack quantity:** 4 profiles including fixing accessories.

Catalog no.	For enclosure	
	D	Max. loading
DIP210	210	150 N
DIP260	260	150 N
DIP300	300	150 N
DIP400	400	150 N

All measurements in mm.



Scan QR code to watch an instructional video

## 19" profiles, AVP

**Description:** For 600 mm wide enclosures only. Adjustable depth with the use of the AMG accessory. Usable depth between 19" profiles and external door: 56 mm. Fitted onto the hinge holes located on the front frame of the enclosure. For stainless steel enclosures, machining is required.

**Material:** 2 mm galvanized steel.

**Pack quantity:** 1 pair with mounting accessories.

Catalog no.	For enclosure	
	H	U
AVP0400	400	9
AVP0600	600	13
AVP0800	800	17
AVP1000	1000	21
AVP1200	1200	26



*Not suitable for AFS.*  
All measurements in mm.

# Wall Mounted

## Accessories

### Vertical mounting profiles, AVB

**Description:** For the mounting of swing frames in full and partial height. The SFBP is mounted directly to the AVB. Equipped with 25 mm hole pattern. For other mounting purposes CNM cage nuts can be used. Fitted onto the hinge holes located on the front frame of the enclosure. For stainless steel enclosures, machining is required.

**Material:** 2 mm galvanized steel.

**Pack quantity:** 1 pair with mounting accessories.

Catalog no.	For enclosure	
	H	
AVB0400	400	
AVB0600	600	
AVB0800	800	
AVB1000	1000	
AVB1200	1200	
AVB1400	1400	

Not suitable for AFS.

All measurements in mm.



### Modular chassis, AC

**Description:** Used for easy mounting of DIN-rail components with a maximum height of 68 mm. Distance between rows 125 mm. If required, the standard enclosure door can be replaced with a glazed door. Usable depth between front cover and external door: 35 mm. In stainless steel enclosure machining is required.

**Material:** DIN-rails PP0735 made of 1.2 mm galvanized steel, vertical profiles 1.5 mm mild steel, and front cover 1.5 mm mild steel.

**Finish:** RAL 7035 structured powder coating.

**Pack quantity:** Slotted front panel, two vertical profiles, top and bottom blank panels, one DIN-rail per row, and mounting accessories.

**Mounting requirements:** To be assembled on MAS and ASR enclosures.

Catalog no.	For enclosure		N° of modules	N° of rows
	H	W		
AC05040R5	500	400	48	3
AC06040R5	600	400	64	4
AC08060R5	800	600	162	6

All measurements in mm.



## Enclosure pole fixation, EPF

- Description:** Accessory to fix enclosures onto poles. Maximum load of 900N.
- Material:** Galvanized steel.
- Minimum pole diameter:** 80 mm.
- Maximum pole diameter:** 250 mm.
- Pack quantity:** 2 profiles, 2 circular mounting strips for pole attachment and mounting accessories.

Catalog no.	For Enclosure (W)
	STB, SSTB
EPF0300	300
EPF0400	400
EPF0500	500
EPF0600	600

All measurements in mm.



## Front/rear plinths, P

- Description:** Four corner pieces with removable front covers. The side panels PA must be ordered separately. Available heights: 100 and 200 mm. Machining is required.
- Material:** 2.5 mm mild steel for corner pieces and 1.5 mm mild steel for covers.
- Finish:** RAL 7022 structured powder coating.
- Pack quantity:** 4 corner pieces and 2 front covers, with mounting accessories.

Catalog no.	Plinth	For enclosure
	Height	Width
P1060	100	600
P1080	100	800
P2060	200	600
P2080	200	800

All measurements in mm.



# Wall Mounted

## Accessories

### Side plinths, PA

- Description:** Side covers for plinth P, strengthened by folded edges.
- Material:** 1.5 mm mild steel.
- Finish:** RAL 7022 structured powder coating.
- Pack quantity:** 2 pieces for height 100 mm and 4 pieces for height 200 mm.

Catalog no.	Plinth	For enclosure
	Height	Depth
PA1030	100	300
PA1040	100	400

All measurements in mm.



### Floor stands, PFF

- Description:** Floor stands for floor mounting to give a suitable operation height. Available for 300 mm depth enclosures with  $W \geq 400$  mm. 300 or 450 mm high are available. Machining is required.
- Material:** 2 mm mild steel.
- Finish:** RAL 7035 structured powder coating.
- Pack quantity:** 2 pieces with mounting accessories.

Catalog no.	Plinth	For enclosure
	Height	Depth
PFF345R5	450	300

Not suitable for AFS.

All measurements in mm.



## Transparent doors, ADT

- Description:** To replace the standard door, it provides a clear view of the components installed inside the enclosure. The lock(s) are interchangeable with all nVent HOFFMAN's standard lock(s).
- Material:** 1.2 mm mild steel / 1.5 mm for enclosures with a height or width of 500 mm or greater / 2 mm for enclosures with a height or width of 800 mm or greater and 3 mm transparent acrylic glass.
- Finish:** RAL 7035 structured powder coating.
- Protection:** Complies with IP55, IK 07.
- Pack quantity:** 1 door.



Catalog no.	For enclosure		Viewing area		N° of locks
	H	W	h	w	
ADT03025R5	300	250	159	93	1
ADT03030R5	300	300	159	143	1
ADT04030R5	400	300	259	143	1
ADT04040R5	400	400	259	243	1
ADT05030R5	500	300	359	143	1
ADT05040R5	500	400	359	243	1
ADT06040R5	600	400	459	243	2
ADT06050R5	600	500	459	343	2
ADT06060R5	600	600	459	443	2
ADT07050R5	700	500	559	343	2
ADT08060R5	800	600	659	443	2
ADT10060R5	1000	600	859	427	1*
ADT10080R5	1000	800	859	627	1*
ADT12060R5	1200	600	1059	427	1*
ADT12080R5	1200	800	1059	627	1*

\* 3-point espagnolette locking.  
Not suitable for AFS.

All measurements in mm.

# Wall Mounted

## Accessories

### Glazed doors, ADC

- Description:** To replace the standard door, it provides a clear view of the components installed inside the enclosure. The lock(s) are interchangeable with all nVent HOFFMAN's standard lock(s).
- Material:** 1.2 mm mild steel / 1.5 mm for enclosures with a height or width of 500 mm or greater / 2 mm for enclosures with a height or width of 800 mm or greater and 4 mm clear safety glass.
- Finish:** RAL 7035 structured powder coating.
- Protection:** Complies with IP 55 | TYPE 12, 13, IK 07.
- Pack quantity:** 1 door.



Catalog no.	For enclosure		Viewing area		N° of locks
	H	W	h	w	
ADC03025R5	300	250	159	93	1
ADC03030R5	300	300	159	143	1
ADC04030R5	400	300	259	143	1
ADC04040R5	400	400	259	243	1
ADC05030R5	500	300	359	143	1
ADC05040R5	500	400	359	243	1
ADC06040R5	600	400	459	243	2
ADC06050R5	600	500	459	343	2
ADC06060R5	600	600	459	443	2
ADC07050R5	700	500	559	343	2
ADC08060R5	800	600	659	443	2
ADC10060R5	1000	600	859	427	1*
ADC10080R5	1000	800	859	627	1*
ADC12060R5	1200	600	1059	427	1*
ADC12080R5	1200	800	1059	627	1*

\* 3-point espagnolette locking.  
Not suitable for AFS.

All measurements in mm.

## Wall mounting brackets, AW

- Description:** Mounting brackets for safe wall fixing. It includes the sealing washers to guarantee the IP rating.
- Material:** 3 mm zinc plated steel.
- Pack quantity:** 4 brackets with mounting accessories.

Catalog no.
AW41



## Wall mounting brackets, AWS

- Description:** Mounting brackets for safe wall fixing. It includes the sealing washers to guarantee the IP rating. In stainless steel machining is required.
- Pack quantity:** 4 brackets with mounting accessories.

Catalog no.	Material
AWS41-304	3 mm stainless steel 304
AWS41-316	3 mm stainless steel 316

All measurements in mm.



# Wall Mounted

## Accessories

### Inner doors, ADI

- Description:** For controls, meters, lamps, etc. Hinges can be mounted to allow left or right hand opening. Lock double-bit 3 mm insert; 700 mm high doors and above have 2 locks. Usable depth between inner and external door: 35 mm. Adjustable depth position with AMG accessory. Workable area: H-55, W- 108. 19" version available on request. Machining is required for stainless steel enclosures.
- Material:** Door 1.5 mm mild steel, vertical top and bottom profiles 2 mm mild steel.
- Finish:** RAL 7035 structured powder coating.
- Protection:** IP 2XC.
- Pack quantity:** Inner door, two vertical profiles, top and bottom profiles and mounting accessories.

Catalog no.	For enclosure		Inner door dimensions		N° of locks
	H	W	h	w	
ADI04030R5	400	300	345	192	1
ADI05040R5	500	400	445	292	1
ADI06040R5	600	400	545	292	1
ADI06060R5	600	600	545	492	1
ADI08060R5	800	600	745	492	2
ADI10080R5	1000	800	945	692	2
ADI12080R5	1200	800	1145	692	2

Not suitable for AFS.

All measurements in mm.



## 180° Hinges, MMH

- Description:** Door hinges that allow the door to open 180°. Machining is not required.
- Material:** Zamak.
- Pack quantity:** MMH02 - 2 pcs. MMH03 - 3 pcs.

	For enclosure
Catalog no.	H
MMH02	≤ 800 mm
MMH03	> 800 mm

All measurements in mm.



## 180° Hinges, MMHS

- Description:** Door hinges that allow the door to open 180°. Machining is not required.
- Material:** Stainless steel 316.
- Pack quantity:** MMHS02 - 2 pcs. MMHS03 - 3 pcs.

	For enclosure
Catalog no.	H
MMHS02	≤ 800 mm
MMHS03	> 800 mm

All measurements in mm.





# Wall Mounted

01

## Accessories

02

### Door stop, ADO

**Description:** Door stop to fit all wall mounted enclosure dimensions. To secure the door in an open position to the degree that meets user requirements. Door stop can be mounted at the top or bottom of the enclosure. Machining is required. Minimum enclosure width  $\geq$  300 mm.

**Pack quantity:** 1 piece with mounting accessories.

Catalog no.	Material
ADO202	3 mm thick zinc plated steel
ADO202S	2.5 mm stainless steel AISI 316L

All measurements in mm.



Scan QR code to watch an instructional video

Wall Mounted Enclosures

03

### Door switch, ADSW

**Description:** Door switch to activate any electrical device (lighting, signalling, alarms, etc.) designed for wall mounted enclosures. Cable entry M20. In stainless steel enclosures, machining is required.

**Switch capacity:** 3 A / 240 V.

**Approvals:** CE, EAC, cULus listed.

**Pack quantity:** 1 piece with mounting accessories.

Catalog no.
ADSW01



Scan QR code to watch an instructional video

## Door mounting profiles, MMDP

- Description:** To strengthen the door and provide further mounting possibilities. Mounted on the inside of the door onto M6 welded studs. Equipped with a 10 mm hole pattern. These door profiles cannot be used with the AFS enclosure range.
- Material:** 1.2 mm galvanized steel.
- Dimension:** 15 x 14 mm.
- Pack quantity:** 1 pair with mounting accessories.



	For enclosure
Catalog no.	H
MMDP040	400
MMDP050	500
MMDP060	600
MMDP070	700
MMDP080	800
MMDP100	1000
MMDP120	1200
MMDP140	1400

*Not suitable for AFS.*  
All measurements in mm.



01

02

Wall Mounted Enclosures

03

# Wall Mounted

## Accessories

### Inserts, ALIS

**Description:** Inserts to replace the standard double-bit 3 mm insert in the standard ALLS503 lock.

**Material:** Zamak chrome plated.

**Pack quantity:** 1 piece.



Catalog no.	Description
ALIS528	Slotted 2 x 4 mm

*Not suitable for AFS.*  
All measurements in mm.

### Locks, ALL

**Description:** Alternative locks to replace the standard one.

**Pack quantity:** 1 piece.



Catalog no.	Description	Type	Protection
ALL503N	Plastic	DIN 3 mm	IP 66
ALL508	Chrome plated lock with cylinder	Ronis key n° M21323	IP 65
ALL509	Polyamide lock with cylinder	Key 5333	IP 55
ALL510N	Lock with cylinder	Ronis key n° C21323	IP 65

*Not suitable for AFS.*  
All measurements in mm.

### Double-bit 3 mm stainless steel locks, ALLS

**Description:** Stainless steel double-bit 3 mm lock.

**Pack quantity:** 1 piece.



Catalog no.	Description	Protection
ALLS304	AISI 304 stainless steel	IP 65
ALLS316	AISI 316L stainless steel	IP 66
ALLS503N	Chrome plated Zamak	IP 66

## Padlocking, PLC

**Description:** The padlocking cover is mounted over the existing standard lock. The standard lock is completely covered and not accessible when padlock is fitted. Maximum padlock bow diameter of 10 mm.

**Material:** Stainless steel.

**Pack quantity:** 1 piece.

Catalog no.
PLC01



Not suitable for AFS.

## Handles, ALT

**Description:** Alternative handles to replace the standard lock.

**Pack quantity:** 1 piece.

Catalog no.	Description	Protection
ALT560	Plastic handle	IP 66
ALT561	Chrome plated T-handle with cylinder lock, key M21323	IP 65
ALT562	Chrome plated handle with cylinder lock, key M21323	IP 65
ALT563	Plastic handle with cylinder lock, Key 5333	IP 65



Other locking options available, please contact our sales representative. Not suitable for AFS.

# Wall Mounted

## Accessories

### Keys, LSK

**Description:** Key with nVent logo. Easy to use design, providing a good grip.

**Pack quantity:** 1 piece.

Catalog no.	Description	Material
LSK502	Double-bit 3 mm	Plastic
LSK503	Double-bit 3 mm	Metalic
LSK505	Double-bit 5 mm	Metalic
LSK524	Square 8 mm	Metalic
LSK527	Triangle 8 mm	Metalic

All measurements in mm.



Wall Mounted Enclosures

### Wall mounted combining kit, CK

**Description:** Wall mounting combining kit is to be used for buying two or more wall mounted enclosures together, side by side. This enables customers to create many more enclosure configurations than previously available.

**Material:** EPDM rubber 10 mm thick.

**Pack quantity:** Combining kit provided in a puzzle format, along with mounting accessories.

Catalog no.
CK01

Not suitable for AFS.



### Gland plate combining gaskets, AGC

**Description:** To be used when a wall mounted enclosures combination (MAS/MAD/MAP) is needed. Combining gaskets are to be used to bay gland plate openings together.

**Material:** 8 mm polyethylene foam.

**Pack quantity:** 2 pieces, and combination mounting accessories.

Catalog no.	For opening	Gland plate type
AGC02	310 x 96	2
AGC03	410 x 96	3
AGC04	510 x 96	4

All measurements in mm.



## Lifting eyes, AL

- Description:** M12 thread. Complies with DIN 580 lifting requirements. Machining is required.
- Material:** Steel.
- Pack quantity:** 2 eye-bolts, 2 reinforcements and mounting accessories.

Catalog no.
AL9301

Not suitable for AFS.



## Standard gland plates, AF

- Description:** Gland plates for the standard gland opening.
- Material:** 1.4 mm mild steel.
- Finish:** RAL 7035 structured powder coating.
- Pack quantity:** 1 piece.

Catalog no.	For opening	Gland plate type
AF00SR5	110 x 56	0S
AF01SR5	210 x 56	1S
AF02SR5	310 x 56	2S
AF03SR5	410 x 56	3S
AF01R5	210 x 96	1
AF02R5	310 x 96	2
AF03R5	410 x 96	3
AF04R5	510 x 96	4

All measurements in mm.



## Gland plate gaskets, AG

- Description:** For standard gland plate opening.
- Material:** 4 mm polyethylene foam.
- Pack quantity:** 1 piece.

Catalog no.	For opening	Gland plate type
AG00S	110 x 56	0S
AG01S	210 x 56	1S
AG02S	310 x 56	2S
AG03S	410 x 56	3S
AG01	210 x 96	1
AG02	310 x 96	2
AG03	410 x 96	3
AG04	510 x 96	4

All measurements in mm.



# Wall Mounted

## Accessories

### Adapter gland plates, AFA

- Description:** Adapts FL gland plates to the wall mounted, steel enclosures gland opening.
- Material:** 1.4 mm mild steel.
- Finish:** RAL 7035 structured powder coating.
- Pack quantity:** 1 piece.

Catalog no.	For opening	N° of FL openings	Gland plate type
AFA01R5	210 x 96	1xFL13	1
AFA02R5	310 x 96	1xFL21	2
AFA03R5	410 x 96	1xFL21	3
AFA04R5	510 x 96	2xFL21	4

All measurements in mm.



### Gland plates with knock-outs, AFK

- Description:** Gland plates with knock-outs according to table.
- Material:** 1.4 mm mild steel.
- Finish:** RAL 7035 structured powder coating.
- Pack quantity:** 1 piece.

Catalog no.	For opening	M16	M20	M25	M32	Gland plate type
AFK21R5	310 x 96	9	5	4	2	2
AFK31R5	410 x 96	18	5	4	2	3
AFK41R5	510 x 96	27	5	4	2	4
AFK42R5	510 x 96	18	14	3	1	4

All measurements in mm.



## Plastic cable plates, EHTC

- Description:** Gland plates suitable for leading through cables as well as different types of tubing. To be installed directly to the adapter gland plate AFA. Please see the cable management section.
- Material:** Different types of polymers reinforced with a steel plate. Halogen free and UV resistant.
- Protection:** IP 65.
- Finish:** RAL 7035.
- Pack quantity:** 1 piece with mounting accessories.



Catalog no.	For opening
EHTC2125G	FL21
EHTC213G	FL21
EHTC2135G	FL21
EHTC2150G	FL21

## Rain hood, ARF

- Description:** To be fitted as an outdoor shelter on single mounted enclosures. The roof is slightly sloped and has a dripstrip. Machining is required. It increases the enclosure dimension in H:60 mm, D:20 mm and W:20 mm.
- Material:** 1.5 mm mild steel.
- Finish:** RAL 7035 structured powder coating.
- Pack quantity:** 1 rain hood with mounting accessories.
- Additional information:** If the rain hood is exposed to high levels of UV radiation, the ARF should be coated with 100% polyester paint. This can be ordered as a special accessory. The ARF is not compatible with 180° MMH hinges.



Catalog no.	For enclosure	
	W	D
ARF02515R5	250	155
ARF03015R5	300	155
ARF03021R5	300	210
ARF04021R5	400	210
ARF04030R5	400	300
ARF05021R5	500	210
ARF05030R5	500	300
ARF06021R5	600	210
ARF06026R5	600	260
ARF06030R5	600	300
ARF08030R5	800	300
ARF08040R5	800	400
ARF10030R5	1000	300

Not suitable for AFS.  
All measurements in mm.

# Terminal Boxes Mild Steel

## Mild steel terminal box | STB

IP 66 | TYPE 4, 12 | IK 08

**Material:**

1.2 mm mild steel.

**Body:**

Folded and seam welded. Four 8.5 mm diameter holes for wall fixing. Four M6 x 13 studs for bottom profiles / mounting plate fixation.

**Gasket:**

Sealing is ensured by an injected one piece polyurethane gasket.

**Earthing:**

M8x18 mm earthing studs in body and cover, M8 nuts, earthing washers and earthing labels.

**Protection:**

IP 66 | TYPE 4, 12 | IK 08.

**Finish:**

RAL 7035, structured powder coating.

**Delivery:**

Body, cover, cover screws, fixing screws, cover plugs, and earthing facilities.



# Dimensional table | STB

IP 66 | TYPE 4, 12 | IK 08

Catalog no.	Box dimension			Weight (kg)
	H	W	D	
STB151508	150	150	80	1.15
STB151512	150	150	120	1.35
STB153008	150	300	80	1.90
STB153012	150	300	120	2.25
STB202012	200	200	120	2.00
STB204012	200	400	120	3.35
STB303008	300	300	80	3.15
STB303012	300	300	120	3.55
STB304012	300	400	120	4.50
STB305012	300	500	120	5.40
STB408012	400	800	120	9.90

All measurements in mm.

## Dimensional drawing | STB

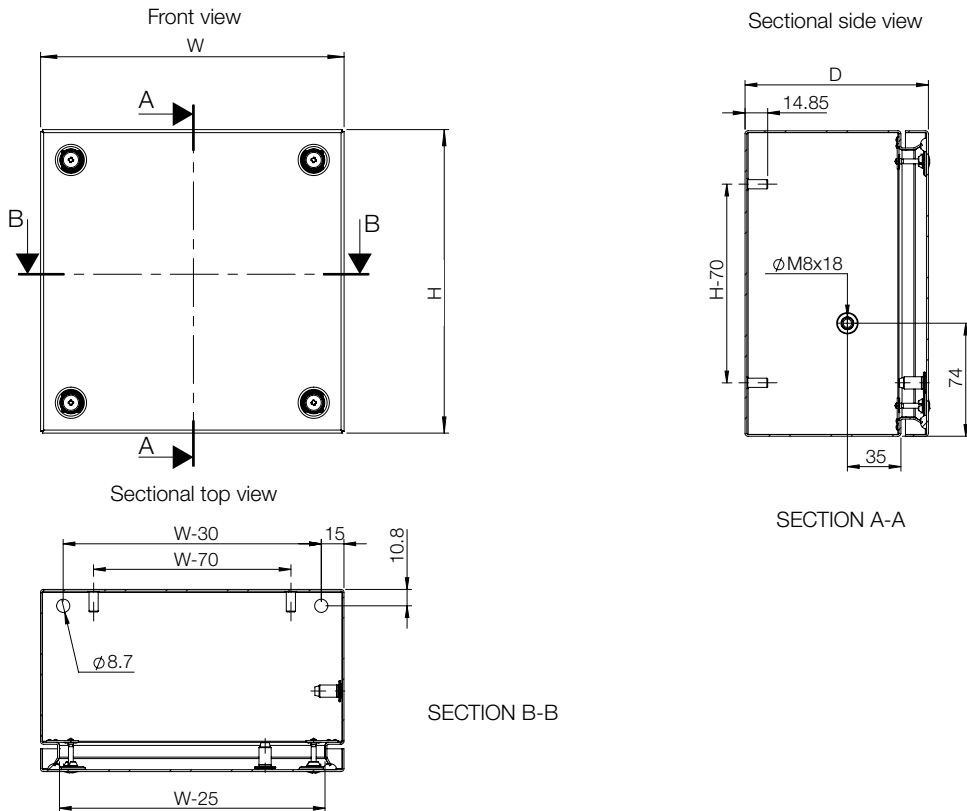

# Terminal Boxes Stainless Steel

## Stainless steel terminal box | SSTB

IP 66 | TYPE 4X, 12 | IK 08

**Material:**

AISI 304 pre-grained stainless steel / AISI 316L (on request).  
Body: 1 mm. Cover: 1.5 mm.

**Body:**

Folded and seam welded. Four M6x13 studs for bottom profile / mounting plate fixation.

**Gasket:**

For AISI 316L, sealing is ensured by an injected one piece silicone gasket.

**Earthing:**

M8x18 mm earthing studs in body and cover, M8 nuts, earthing washers and earthing labels.

**Protection:**

IP 66 | TYPE 4X, 12 | IK 08.

**Finish:**

400 pre-grained stainless steel.

**Delivery:**

Body, cover, cover screws, fixing screws, cover plugs and earthing facilities.



# Dimensional table | SSTB

IP 66 | TYPE 4X, 12 | IK 08

Catalog no.	Box dimension			Weight (kg)
	H	W	D	
SSTB151508	150	150	80	1.10
SSTB151512	150	150	120	1.30
SSTB153012	150	300	120	2.15
SSTB202012	200	200	120	1.95
SSTB203012	200	300	120	2.55

All measurements in mm.

# Dimensional drawing | SSTB

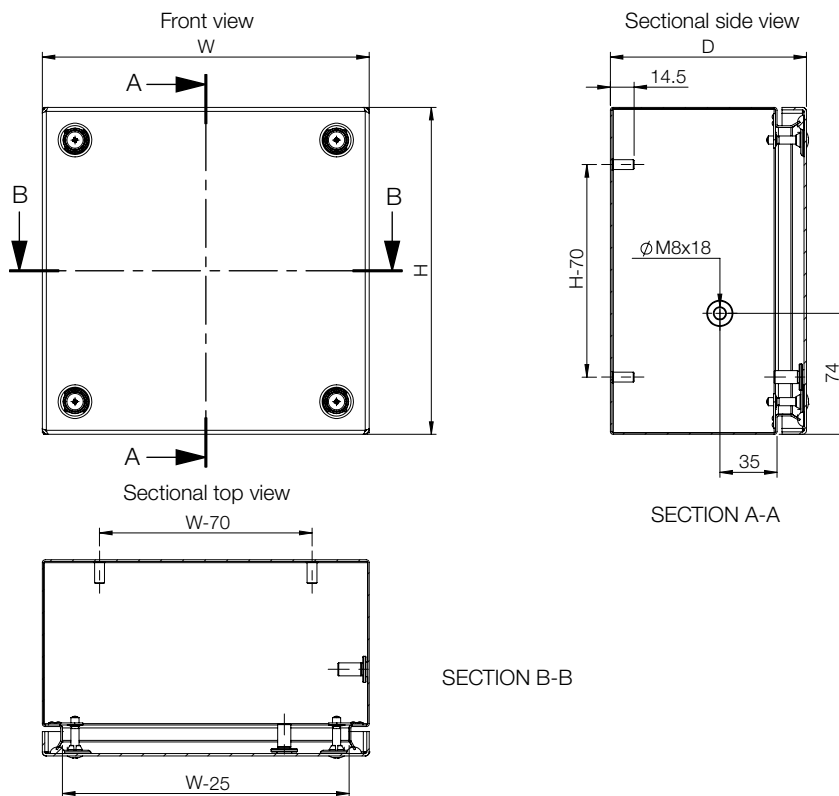

# Terminal Boxes

## Accessories

### Mounting plate, BMP

**Description:** Steel mounting plate for terminal boxes.  
**Material:** 2 mm galvanized steel.  
**Pack quantity:** 1 piece.



Catalog no.	Box dimension		Mounting plate dimensions	
	H	W	h	w
BMP1515	150	150	125	120
BMP1530	150	300	125	270
BMP2020	200	200	175	170
BMP2030	200	300	175	270
BMP2040	200	400	175	370
BMP2050	200	500	175	470
BMP3030	300	300	275	270
BMP3040	300	400	275	370
BMP4040	400	400	375	370
BMP4080	400	800	380	770

All measurements in mm.

### Bottom profile, BPP

**Description:** Bottom profile for DIN rail mounting.  
**Material:** Galvanized steel.  
**Pack quantity:** 2 pieces.



Catalog no.	For box
	H/W
BPP15	150
BPP20	200
BPP30	300
BPP40	400
BPP50	500
BPP60	600
BPP80	800

All measurements in mm.

## DIN rail, BDR

**Description:** DIN rail 35 mm for terminal boxes.  
**Material:** Galvanized steel.  
**Pack quantity:** 5 pieces.

	For box
Catalog no.	H/W
BDR3515	150
BDR3520	200
BDR3530	300
BDR3540	400
BDR3550	500
BDR3560	600
BDR3580	800

All measurements in mm.



## Hinges, STBH

**Description:** Using this accessory the cover can be hinged. Machining is required.  
**Material:** Zinc plated steel.  
**Pack quantity:** Set of 2 hinges with mounting accessories.

Catalog no.
STBH02



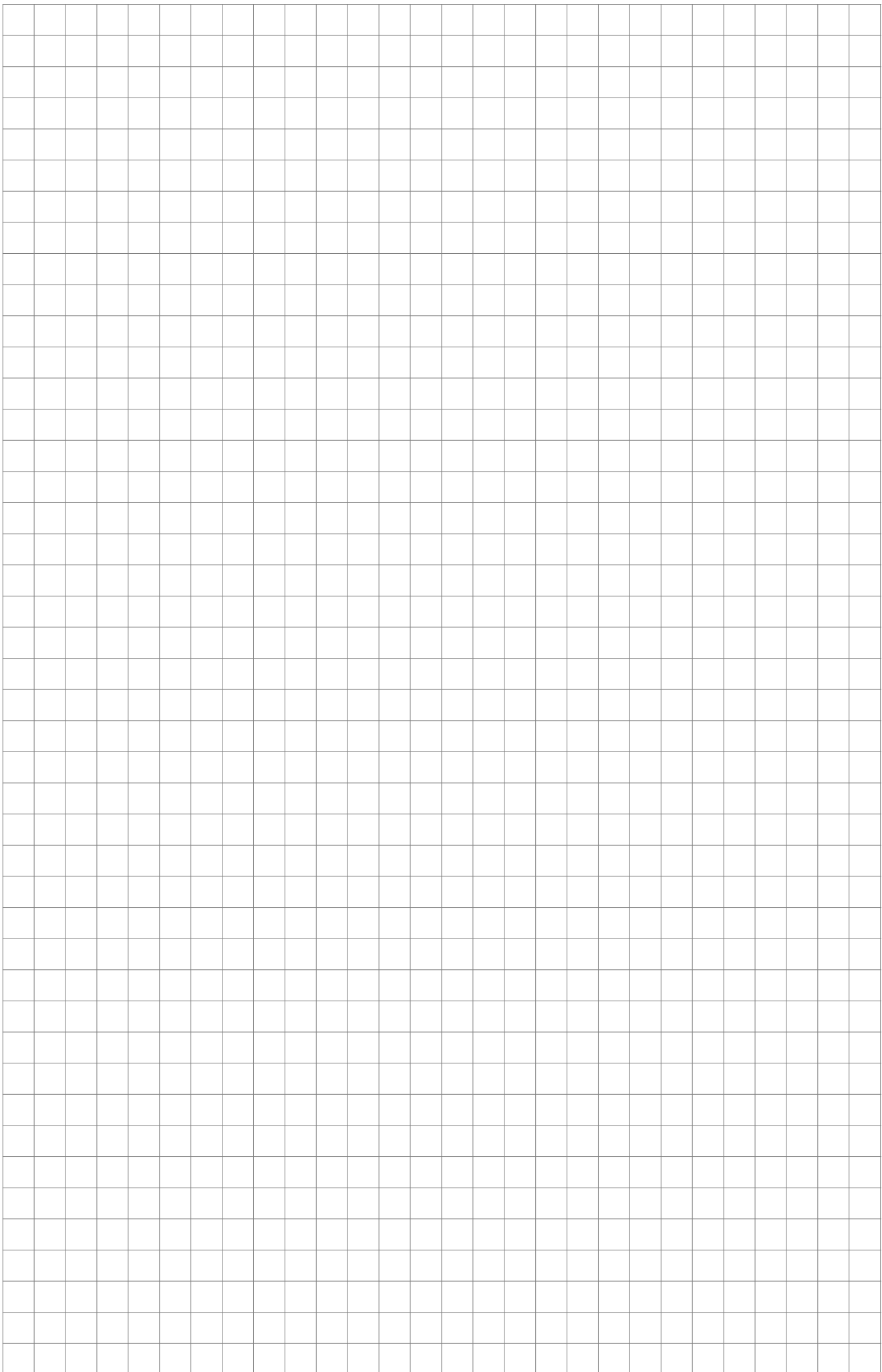

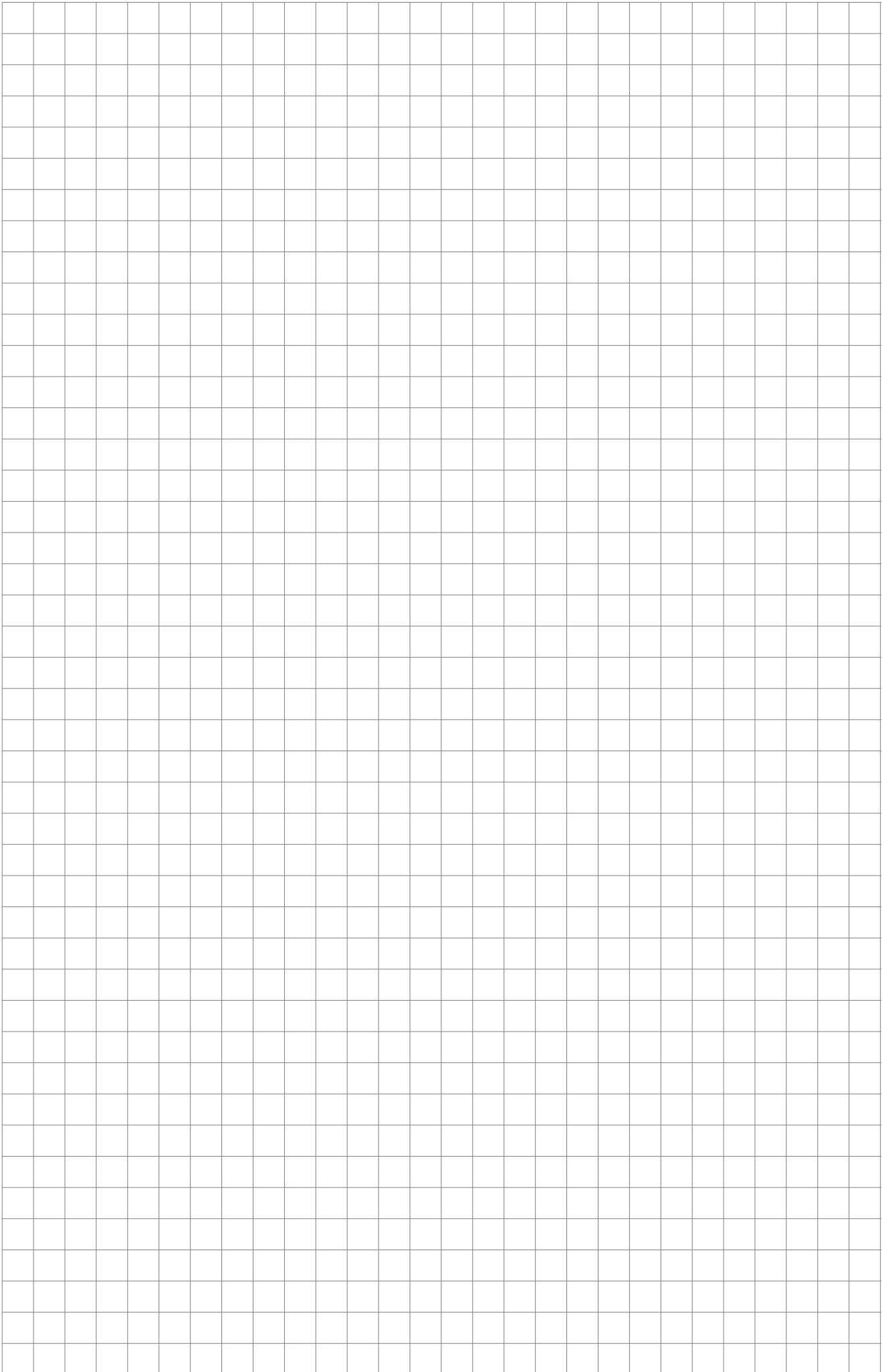

nVent.com



Our powerful portfolio of brands:

**CADDY ERICO HOFFMAN ILSCO SCHROFF TRACHTE**

©2026 nVent. All nVent marks and logos are owned or licensed by nVent Services GmbH or its affiliates. All other trademarks are the property of their respective owners. nVent reserves the right to change specifications without notice.  
nVentHOFFMAN-CAT-N02569-IECproductcatalogNA-USEN-2602

**Distributed by Gross Automation | +1 (262) 252-1600 | [sales@grossautomation.com](mailto:sales@grossautomation.com)**