

# Lights & Sirens

## 2026 Catalog



**Safety in  
this moment.**  
That's Federal Signal Strength.



# RISK REDUCTION IN EMERGENCY RESPONSE

## How Emergency Vehicle Warning Lights and Sirens Reduce the Risk of Accidents

When every second counts, first responders face significant risks—to their own safety and to the public’s. Emergency vehicle warning lights and sirens deliver clear, visual, and audible warning signals that help drivers and pedestrians detect, recognize, and respond.

**It is all about safety in the moment—reducing accidents and making emergency responses safer.**



### WHAT ARE THE RISKS?

Risks to first responders and the public during an emergency response include:



#### Physical Risks

Risks of injury or death due to vehicle accidents or delayed response



#### Financial Implications

Increased property damage when emergency vehicles are delayed, increased insurance premiums, and downtime for out-of-service emergency vehicles.



#### Legal Exposure

Potential for lawsuits and liability for municipalities and departments.

## 4 ELEMENTS OF RISK REDUCTION

An understanding of the factors associated with an effective vehicular emergency warning system can minimize risks.

#### Awareness of Human Factors

Humans process signals in three phases: detection, recognition, and response.

#### Proper Installation, Operation, and Maintenance

Ensuring the right system is installed, operated, and maintained for optimal safety.

#### Suitably Engineered Equipment

Choose and specify the products and technologies designed and best suited for your vehicle’s specific vocation or application.



#### Knowledge of Industry Standards

Become familiar with the organizations that have established minimum performance standards for emergency warning devices.

## HUMANS PROCESS SIGNALS IN THREE PHASES

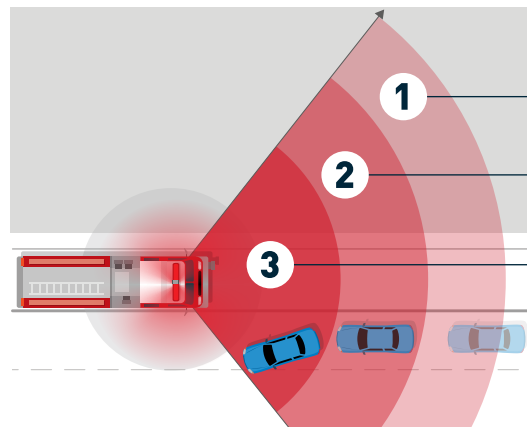
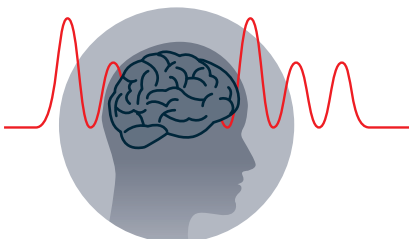

- **Detection:**  
The driver’s initial awareness of a signal
- **Recognition:**  
The driver determines what the signal is and what it means.
- **Response:**  
The driver modifies behavior.

**Safety in this moment.**  
That’s Federal Signal Strength.

Contact your Federal Signal Sales Representative today to learn how our solutions help your fleet reduce risk and save lives.

[pssinsidesales@fedsig.com](mailto:pssinsidesales@fedsig.com)  
[www.fedsig.com/fire](http://www.fedsig.com/fire)

**Light Bars**

Light Bar Feature Comparison ..... 2  
 Navigator® ..... 3  
 Vision® SLR ..... 6  
 Split Vision® SLR ..... 7  
 Three-Pod Vision® SLR ..... 7  
 Allegiant® Max Serial ..... 8  
 Allegiant® Max Discrete ..... 9  
 Valor® ..... 10  
 Integrity® ..... 11  
 Reliant™ S2 ..... 12  
 Hook Mount Reference Guide ..... 13  
 21" Allegiant® ..... 14  
 HighLighter® Micro ..... 15  
 HighLighter® Elite ..... 15  
 SpectraLux® ILS Low-Profile ..... 16

**Sirens / Speakers**

Siren Feature Comparison ..... 18  
 Q-Siren® ..... 19  
 Pathfinder® PF400 ..... 20  
 Pathfinder® PF200 ..... 21  
 Pathfinder® Accessories ..... 22  
 Pathfinder® OBD Cable Vehicle Reference Chart ..... 24  
 Pathway™ ..... 25  
 PA300 ..... 26  
 PA300-100 ..... 26  
 PA4000 ..... 27  
 Rumbler® ..... 28  
 DynaMax®/ES100C ..... 30  
 AS124 ..... 32  
 TS100-N ..... 33  
 BP Series ..... 33

**Perimeter Lights**

FireRay® LED 4x3 ..... 34  
 FireRay® LED 6x4 ..... 35  
 FireRay® LED 7x3 ..... 36  
 FireRay® LED 9x7 ..... 37  
 QuadraFlare® 4x3 ..... 38  
 QuadraFlare® 6x4 ..... 39  
 QuadraFlare® 7x3 ..... 40  
 QuadraFlare® 9x7 ..... 41  
 MicroPulse® Ultra ..... 42  
 MicroPulse® Ultra D-Pillar ..... 43  
 MicroPulse® C Series ..... 43  
 MicroPulse® Wide Angle Pro ..... 44  
 MicroPulse® Wide Angle 9 ..... 45  
 MicroPulse® Series Brackets and Kits ..... 46  
 DynaFlare® ..... 50

416900 Series ..... 52  
 416300 Series ..... 53  
 XStream® ..... 54  
 SignalTech® LED ..... 55  
 LED Traffic-Clearing Light ..... 56  
 Commander® LED Strip Lights ..... 57  
 Commander® Flashing and Marker Light ..... 57

**SignalMaster™ Warning Lights**

Latitude ..... 58  
 Latitude™ SignalMaster ..... 59  
 QuadraFlare® SignalMaster™ ..... 59  
 CN SignalMaster™ ..... 60  
 MicroPulse SignalMaster™ ..... 61  
 SignalMaster™ Brackets ..... 62  
 MB1 LED Message Board ..... 63

**Beacons**

Pro LED Beacon ..... 64  
 SLR Beacon ..... 65  
 IVP SLR ..... 65

**Area Lighting**

NightSpire® ..... 66  
 COM7 Scene Lights ..... 67  
 COM9 Scene Lights ..... 67

**Compartment Lights**

Commander® 8" LED Interior Light ..... 68  
 Commander® Flex Light ..... 68  
 Commander® 3" Compartment Light ..... 69  
 Commander® 5" LED Interior Light ..... 69

**Backup Alarms**

Evacuator® Series ..... 70  
 2012 Series ..... 70

**Accessories**

Opticom® ..... 71  
 Headlight/Taillight Flashers ..... 71  
 Atkinson Dynamics Intercoms ..... 72  
 Littlite® LED ..... 73  
 Voice Gun ..... 73

**LIMITED WARRANTY TERMS AND CONDITIONS ..... 74**

**General Notes**

1. All voltage is 12 Vdc unless marked otherwise. Contact the factory for pricing and availability of 24 V models.
2. A copy of the Federal Signal warranty and Terms and Conditions that accompany these products can be found at [www.fedsig.com](http://www.fedsig.com).
3. Base models of light bars and other configured products are not available without installed options.
4. For detailed information on how to order, consult the product data sheets or contact the factory at 800-264-3578.
5. When installing equipment inside airbag-equipped vehicles, the installer must ensure that the equipment is installed only in areas recommended by the vehicle manufacturer.
6. Pricing subject to change without notice.



Distributed by Gross Automation | +1 (262) 252-1600 | sales@grossautomation.com



Effective January 19, 2026

# Navigator®



- High-profile, linear light bar
- Available in 10", 18", 25", 45", 53", 60", 73", and 87" lengths
- Single- and dual-color capability
- Front-flood, takedowns, alley lights, work lights, and S/T/T available
- (30) flash patterns
- Low-power mode
- 12 Vdc
- SignalMaster™ directional warning available in 45", 53", and 60" models
- LED Traffic Clearing Light (TCL) available
- Black or Clear bulkheads available





**LED COLOR OPTIONS**











## 10" Navigator Models

MODEL	WARNING LIGHT CAPABILITY	QUADRAFLARE® STATIONARY LIGHT HEADS	SLR ROTATOR	DOME COLOR	MIRROR	CONVERGENCE NETWORK/DISCRETE	MOUNT
NVG10D-NFPA21-D	Red	•		Clear		Discrete	Flat
NVG10D-NFPA21-P	Red	•		Clear		Discrete	Flat
NVG10D-NFPA20	Red	•		Clear		Discrete	Flat
NVG10D-NFPA22-D	Red		•	Clear	Driver-Side	Discrete	Flat
NVG10D-NFPA22-P	Red		•	Clear	Passenger-Side	Discrete	Flat

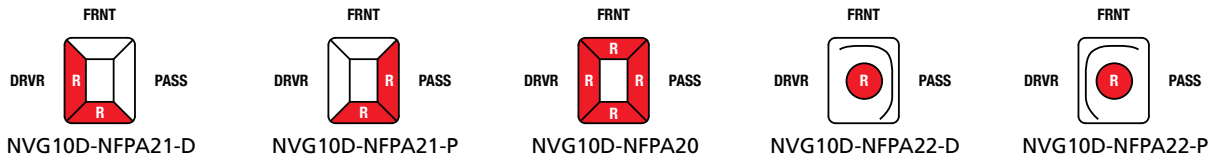

## 18" Navigator Models

MODEL	WARNING LIGHT CAPABILITY	QUADRAFLARE STATIONARY LIGHT HEADS	WHITE LIGHT CUT-OFF	DOME COLOR	BULKHEAD COLOR	CONVERGENCE NETWORK/DISCRETE	MOUNT
NVG18D-NFPA20-D	Red/White	•	•	Clear	Clear	Discrete	4-inch Riser
NVG18D-NFPA20-P	Red/White	•	•	Clear	Clear	Discrete	4-inch Riser



## 25" Navigator Models

MODEL	WARNING LIGHT CAPABILITY	QUADRAFLARE STATIONARY LIGHT HEADS	WHITE LIGHT CUT-OFF	DOME COLOR	BULKHEAD COLOR	CONVERGENCE NETWORK/DISCRETE	MOUNT
NVG25D-NFPA20-D	Red/White	•	•	Clear	Clear	Discrete	4-inch Riser
NVG25D-NFPA20-P	Red/White	•	•	Clear	Clear	Discrete	4-inch Riser
NVG25D-NFPA21	Red	•		Clear	Clear	Discrete	4-inch Riser

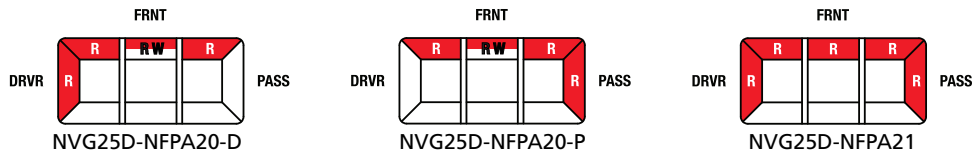

Distributed by Gross Automation | +1 (262) 252-1600 | sales@grossautomation.com

**45" Navigator® Models**

MODEL	WARNING LIGHT CAPABILITY	QUADRAFLARE® STATIONARY LIGHT HEADS	SLR ROTATOR	FLOOD LIGHT	SIGNALMASTER™	WHITE LIGHT CUT-OFF	DOME COLOR	MIRROR	BULKHEAD COLOR	CONVERGENCE NETWORK/DISCRETE	MOUNT
NVG45Z-NFPA20	Red/White	•		•	•	•	Clear		Clear	Convergence Network	Hook
NVG45Z-NFPA21	Red/White	•	•	•	•	•	Clear	End	Clear	Convergence Network	Hook

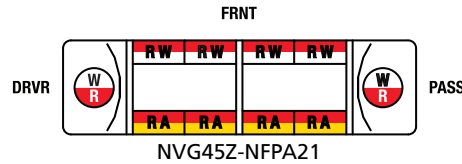
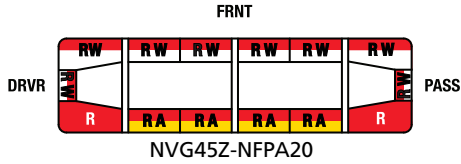

**53" Navigator Models**

MODEL	WARNING LIGHT CAPABILITY	QUADRAFLARE STATIONARY LIGHT HEADS	SLR ROTATOR	FLOOD LIGHT	SIGNALMASTER	WHITE LIGHT CUT-OFF	DOME COLOR	MIRROR	BULKHEAD COLOR	CONVERGENCE NETWORK/DISCRETE	MOUNT
NVG53Z-NFPA20	Red/White	•		•	•	•	Clear		Clear	Convergence Network	Hook
NVG53Z-NFPA21	Red/White	•	•	•	•	•	Clear	End	Clear	Convergence Network	Hook

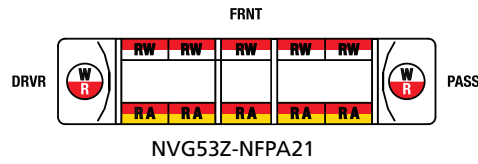
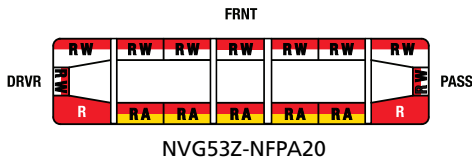

**60" Navigator Models**

MODEL	WARNING LIGHT CAPABILITY	QUADRAFLARE STATIONARY LIGHT HEADS	SLR ROTATOR	FLOOD LIGHT	WHITE LIGHT CUT-OFF	DOME COLOR	MIRROR	BULKHEAD COLOR	CONVERGENCE NETWORK/DISCRETE	MOUNT
NVG60D-NFPA20	Red/White	•	•		•	Clear	End & Rear-Blocking	Clear	Discrete	4-inch Riser
NVG60D-NFPA21	Red/White	•		•	•	Clear		Clear	Discrete	4-inch Riser
NVG60D-NFPA22	Red/White	•		•	•	Clear		Clear	Discrete	4-inch Riser

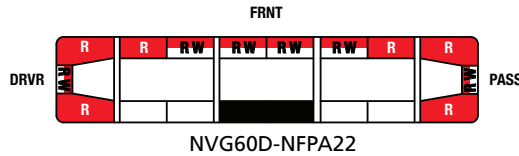
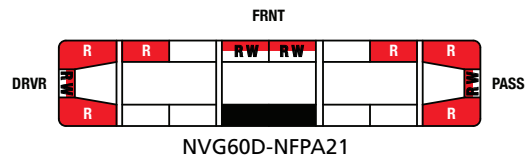
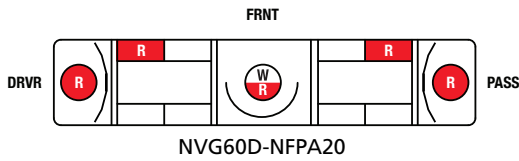

### 73" Navigator® Models

MODEL	WARNING LIGHT CAPABILITY	QUADRAFLARE® STATIONARY LIGHT HEADS	SLR ROTATOR	FLOOD LIGHT	WHITE LIGHT CUT-OFF	DOME COLOR	MIRROR	BULKHEAD COLOR	CONVERGENCE NETWORK/DISCRETE	MOUNT
NVG73D-NFPA20	Red/White	●		●	●	Clear		Clear	Discrete	4-inch Riser
NVG73D-NFPA21	Red/White	●	●	●	●	Clear	End & Rear-Blocking	Clear	Discrete	4-inch Riser
NVG73D-NFPA22	Red/White		●	●	●	Clear	End & Rear-Blocking	Clear	Discrete	4-inch Riser
NVG73D-NFPA23	Red	●				Clear		Clear	Discrete	4-inch Riser
NVG73D-NFPA24	Red/White	●		●	●	Clear		Clear	Discrete	4-inch Riser

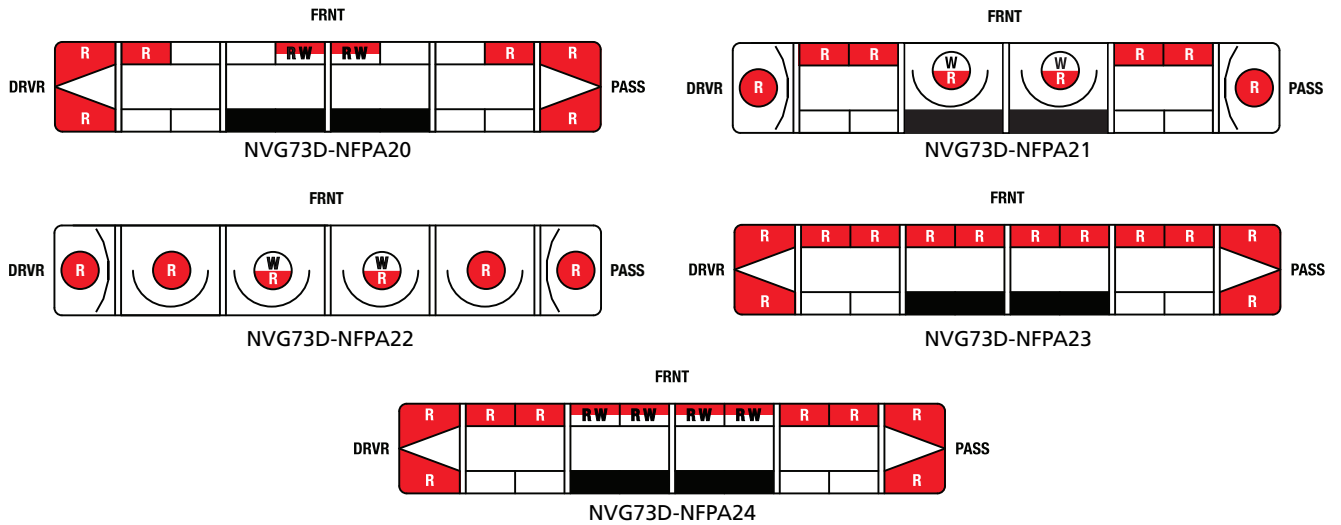

### 87" Navigator Models

MODEL	WARNING LIGHT CAPABILITY	QUADRAFLARE® STATIONARY LIGHT HEADS	SLR ROTATOR	FLOOD LIGHT	WHITE LIGHT CUT-OFF	DOME COLOR	MIRROR	BULKHEAD COLOR	CONVERGENCE NETWORK/DISCRETE	MOUNT
NVG87D-NFPA20	Red/White	●		●	●	Clear		Clear	Discrete	4-inch Riser
NVG87D-NFPA22	Red/White		●	●	●	Clear	End & Rear-Blocking	Clear	Discrete	4-inch Riser

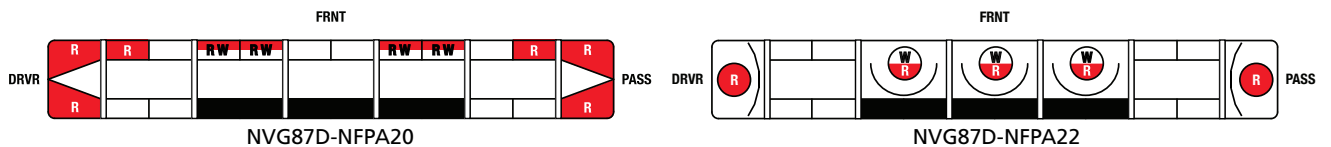

**Notes**

- All SLR rotators spin at 90 FPM
- Flood operation may negate NFPA compliance



Distributed by Gross Automation | +1 (262) 252-1600 | sales@grossautomation.com

# Vision® SLR

- Unique non-linear, V-shape light bar
- Available in 46", 53", and 60" lengths
- Single-, dual-, tri-, and quad-color combinations available
- Left-flood, right-flood, full-flood, alley lights available
- (15) flash patterns
- 12 Vdc
- Aerial view allows emergency vehicle to be seen
- Jogging capability allows user to adjust rotator illuminating an area
- Individual pod replacement for easy service









**LED COLOR OPTIONS**  











MODEL	LENGTH	WARNING LIGHT CAPABILITY	TAKEDOWN LIGHTS	WHITE LIGHT CUT-OFF	SERIAL INTERFACE MODULE	MOUNT
VSLR46S-NFPA1	46-inch	Red/White	Pods 3/5	●	●	Hook
VSLR46S-NFPA2	46-inch	Red/White		●	●	Hook
VSLR46S-NFPA3	46-inch	Red/White	Pods 3/5	●	●	Hook
VSLR46S-NFPA4	46-inch	Red/White		●	●	Hook
VSLR53S-NFPA1	53-inch	Red/White	Pods 3/5	●	●	Hook
VSLR53S-NFPA2	53-inch	Red/White		●	●	Hook
VSLR53S-NFPA3	53-inch	Red/White	Pods 3/5	●	●	Hook
VSLR53S-NFPA4	53-inch	Red/White		●	●	Hook
VSLR60S-NFPA1	60-inch	Red/White	Pods 3/5	●	●	Hook
VSLR60S-NFPA2	60-inch	Red/White		●	●	Hook
VSLR60S-NFPA3	60-inch	Red/White	Pods 3/5	●	●	Hook
VSLR60S-NFPA4	60-inch	Red/White		●	●	Hook

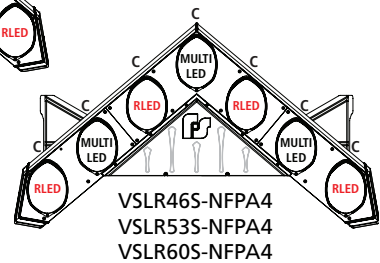
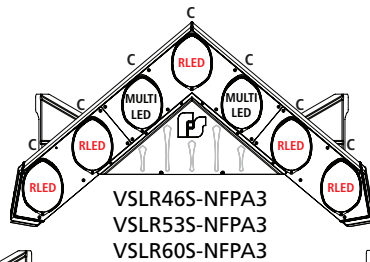
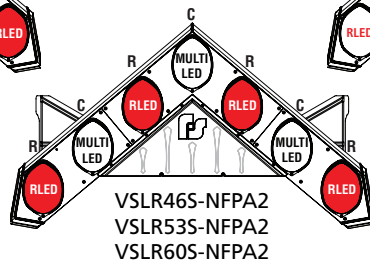
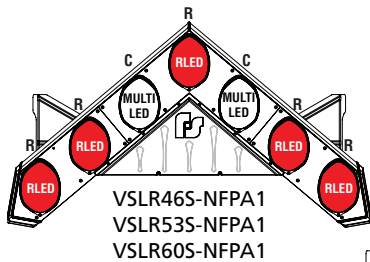

Distributed by Gross Automation | +1 (262) 252-1600 | sales@grossautomation.com

Effective January 19, 2026

# Split Vision® SLR



- Unique non-linear, V-shape light bar
- 6- or 8-pod models
- Single-, dual-, tri-, and quad-color capability
- Left-flood, right-flood, full-flood, alley lights available
- Aerial view allows emergency vehicle to be seen
- Jogging capability allows user to adjust rotator illuminating an area
- (15) flash patterns
- 12 Vdc
- Individual pod replacement for easy service





**LED COLOR OPTIONS**









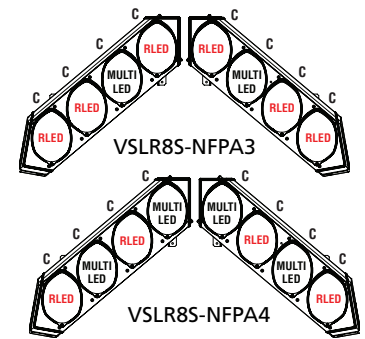
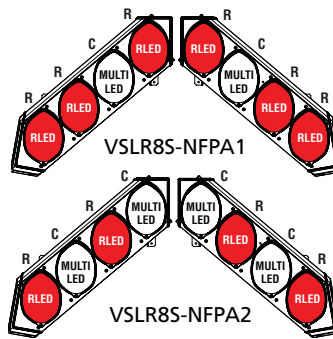
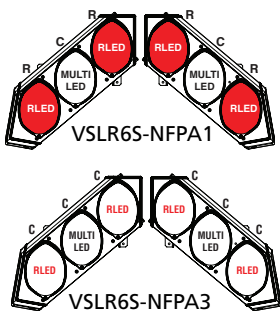

MODEL	PODS	WARNING LIGHT CAPABILITY	TAKEDOWN AND ALLEY LIGHTS	WHITE LIGHT CUT-OFF	DISCRETE	MOUNT
VSLR6S-NFPA1	6 pod (3 each side)	Red/White	●	●	●	Permanent
VSLR6S-NFPA3	6 pod (3 each side)	Red/White	●	●	●	Permanent
VSLR8S-NFPA1	8 pod (4 each side)	Red/White	●	●	●	Permanent
VSLR8S-NFPA2	8 pod (4 each side)	Red/White	●	●	●	Permanent
VSLR8S-NFPA3	8 pod (4 each side)	Red/White	●	●	●	Permanent
VSLR8S-NFPA4	8 pod (4 each side)	Red/White	●	●	●	Permanent

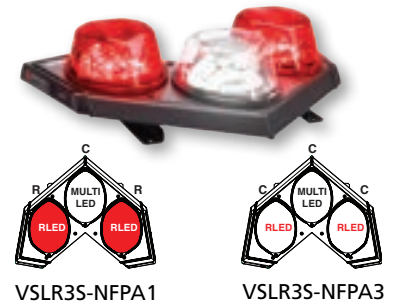

# Three-Pod Vision SLR

- Unique non-linear, V-shape light bar
- Single-, dual-, tri-, and quad-color capability
- Left-flood, right-flood, full-flood, alley lights available
- (15) flash patterns
- 12 Vdc
- Aerial view allows emergency vehicle to be seen
- Jogging capability allows user to adjust rotator illuminating an area
- Individual pod replacement for easy service







**LED COLOR OPTIONS**









MODEL	WARNING LIGHT CAPABILITY	TAKEDOWN LIGHT	WHITE LIGHT CUT-OFF	DISCRETE	MOUNT
VSLR3S-NFPA1	Red/White	●	●	●	Permanent
VSLR3S-NFPA3	Red/White	●	●	●	Permanent



Distributed by Gross Automation | +1 (262) 252-1600 | sales@grossautomation.com

# Allegiant® Max Serial

- Low-profile, linear light bar
- Available in 45", 53", 61", 70", and 80" lengths
- Single-, dual-, and tri-color capability
- Integrated sync capability
- Built-in SignalMaster™ directional warning
- Left-flood, right-flood, full-flood, takedowns, alley lights, alley ground lights, and S/T/T available
- Low-power mode
- (30) flash patterns
- 12 Vdc
- Easy service while installed on the roof top









LED COLOR OPTIONS     







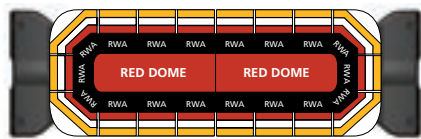

MODEL	LENGTH	WARNING LIGHT CAPABILITY	FLOOD LIGHTS	TD/ALLEY LIGHTS	AMBER SIGNALMASTER	DOMES COLOR	MOUNT	INTEGRATED SYNC	ALLEY GROUND LIGHTS
ALGT45JX-F1LR	45-inch	Amber/Red/White	•	•	•	Red	Low Hook	•	•
ALGT45JX-F2LC	45-inch	Green/Red/White	•	•	•	Clear	Low Hook	•	•
ALGT45JX-F3LC	45-inch	Amber/Blue/White	•	•	•	Clear	Low Hook	•	•
ALGT45JX-F4LC	45-inch	Amber/Blue/Red/White	•	•	•	Clear	Low Hook	•	•
ALGT53JX-F1LR	53-inch	Amber/Red/White	•	•	•	Red	Low Hook	•	•
ALGT53JX-F2LC	53-inch	Green/Red/White	•	•	•	Clear	Low Hook	•	•
ALGT53JX-F3LC	53-inch	Amber/Blue/White	•	•	•	Clear	Low Hook	•	•
ALGT53JX-F4LC	53-inch	Amber/Blue/Red/White	•	•	•	Clear	Low Hook	•	•



ALGT45JX-F1LR

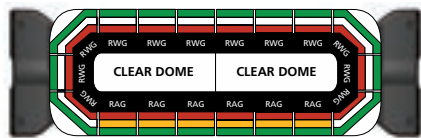

ALGT45JX-F3LC



ALGT45JX-F2LC

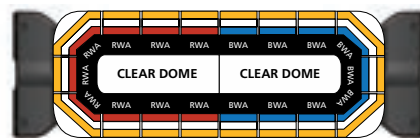

ALGT45JX-F4LC

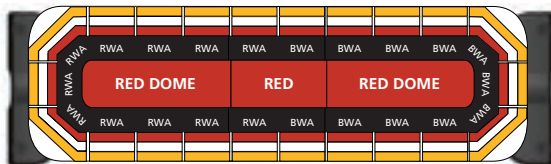

ALGT53JX-F1LR

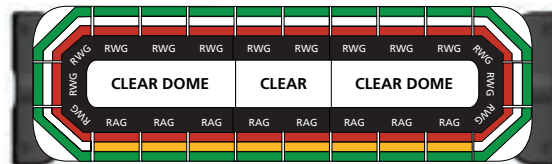

ALGT53JX-F2LC

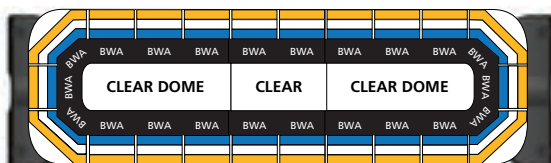

ALGT53JX-F3LC

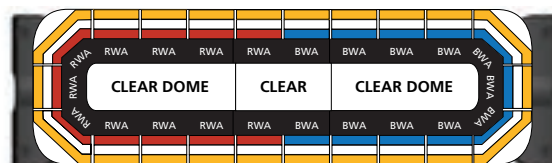

ALGT53JX-F4LC

Distributed by Gross Automation | +1 (262) 252-1600 | sales@grossautomation.com



Effective January 19, 2026

# Allegiant® Max Discrete

- Low-profile, linear light bar
- Available in 45", 53", 61", 70", 80", and 94" lengths
- Single-, dual-, and tri-color capability (except 94")
- Front-flood, takedowns, alley lights, alley ground lights, and S/T/T available
- Low-power mode
- (30) flash patterns
- 12 Vdc
- Easy service while installed on the roof top





**LED COLOR OPTIONS**  











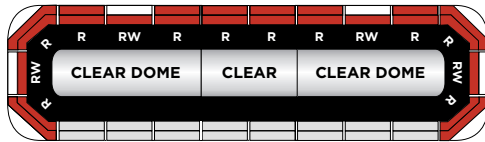

MODEL	LENGTH	WARNING LIGHT CAPABILITY	FLOOD LIGHTS	TD/ALLEY LIGHTS	DOME COLOR	MOUNT
ALGT53XC-NFPA2	53-inch	Red/White		•	Clear	Permanent
ALGT61XC-NFPA2	61-inch	Red/White		•	Clear	Permanent
ALGT61XC-NFPA1	61-inch	Red/White	•		Red	Permanent
ALGT70XC-NFPA2	70-inch	Red/White		•	Clear	Flat

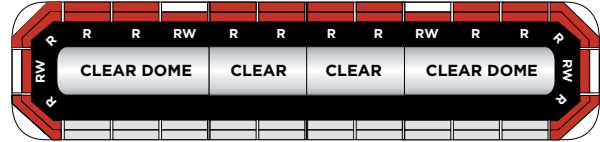

ALGT53XC-NFPA2

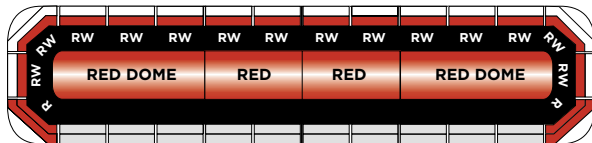

ALGT61XC-NFPA2



ALGT61XC-NFPA1

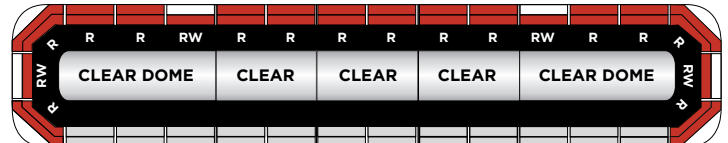

ALGT70XC-NFPA2



Distributed by Gross Automation | +1 (262) 252-1600 | sales@grossautomation.com

# Valor®

- Unique low-profile, non-linear, V-shape light bar
- Available in 44" and 51" lengths
- Single-, dual-, and tri-color capability
- Left-flood, right-flood, full-flood, takedowns, alley lights, work lights, and S/T/T available
- (27) flash patterns
- Low-power mode
- 12 Vdc
- Integrated Vortex™ generators for increased fuel efficiency and reduced wind noise
- Can be serviced without removal from the vehicle roof
- SignalMaster™ directional warning available
- Optional quick-disconnect for easy service removal from vehicle
- Optional HotFoot® mounting for additional alley and takedown lights









**LED COLOR OPTIONS**











MODEL	LENGTH	WARNING LIGHT CAPABILITY	TD/ALLEY LIGHTS	FLOOD LIGHTS	SIGNALMASTER	AMBIENT LIGHT SENSOR	MOUNT
VALR44J-F2H	44-inch	Red/White	•	•	•		Hook
VALR44J-PF3AL	44-inch	Red/Blue/White	•	•	•	•	Low Hook
VALR51J-F2H	51-inch	Red/White	•	•	•		Hook
VALR51J-PF3AL	51-inch	Red/Blue/White	•	•	•	•	Low Hook

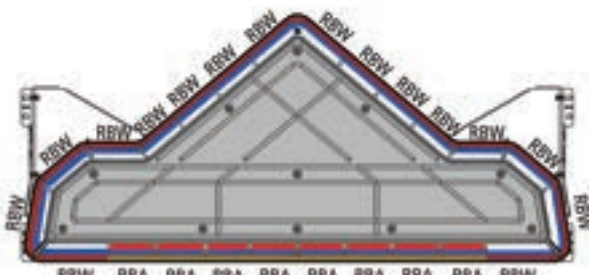

VALR44J-F2H

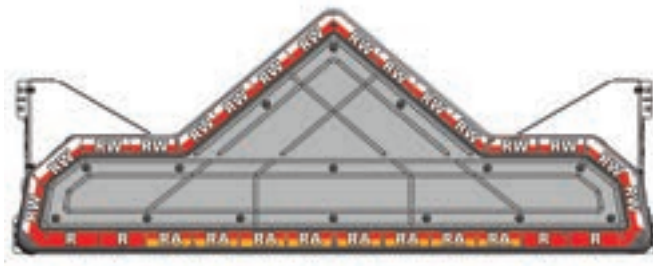

VALR44J-PF3AL



VALR51J-F2H

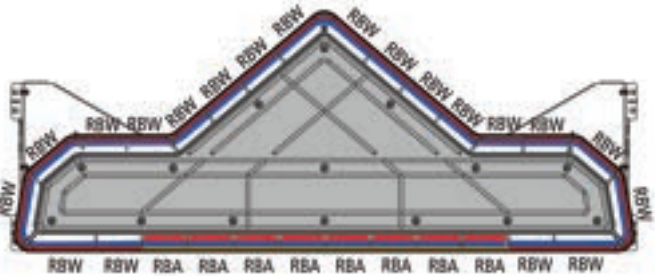

VALR51J-PF3AL

Distributed by Gross Automation | +1 (262) 252-1600 | sales@grossautomation.com



Effective January 19, 2026

# Integrity®

- Unique low-profile, linear light bar
- Available in 44" and 51" lengths
- Single-, dual-, and tri-color capability
- Built-in SignalMaster™ directional warning
- Left-flood, right-flood, full-flood, takedowns, alley lights, and work lights available
- Low-power mode
- (28) flash patterns
- 12 Vdc
- Easy service while installed on the roof top







**LED COLOR OPTIONS**









MODEL	LENGTH	WARNING LIGHT CAPABILITY	TD/ALLEY LIGHTS	FLOOD LIGHTS	SIGNALMASTER	MOUNT
INTG44J-F2H	44-inch	Red/White	●	●	●	Hook
INTG44J-PF3L	44-inch	Red/Blue/White	●	●	●	Low Hook
INTG51J-F2H	51-inch	Red/White	●	●	●	Hook
INTG51J-PF3L	51-inch	Red/Blue/White	●	●	●	Low Hook



INTG44J-F2H



INTG44J-PF3L



INTG51J-F2H

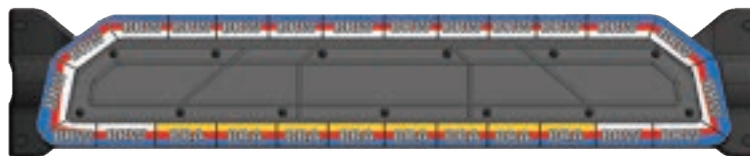

INTG51J-PF3L



Distributed by Gross Automation | +1 (262) 252-1600 | sales@grossautomation.com

# Reliant® S2



- Ultra low-profile, linear light bar
- Available in 48" length
- Single-, dual-, and tri-color capability
- Left-flood, right-flood, full-flood, takedowns, alley lights, and S/T/T available
- Low-power mode
- (28) flash patterns
- 12 Vdc
- Built-in SignalMaster™ directional warning











MODEL	LENGTH	WARNING LIGHT CAPABILITY	DOMES COLORS	TD/ALLEY LIGHTS	FLOOD LIGHTS	AMBER SIGNALMASTER	MOUNT
RLNT48J-01CC	48-inch	Red/Blue/White	Clear	●	●	●	Low Hook
RLNT48J-01RR	48-inch	Red/Blue/White	Red	●	●	●	Low Hook
RLNT48J-02CC	48-inch	Red/Blue/White	Clear	●	●		Low Hook
RLNT48J-02RR	48-inch	Red/Blue/White	Red	●	●		Low Hook

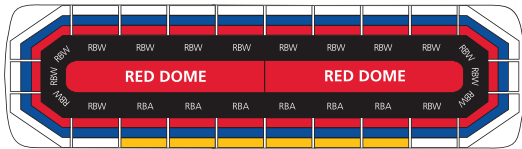

RLNT48J-01RR

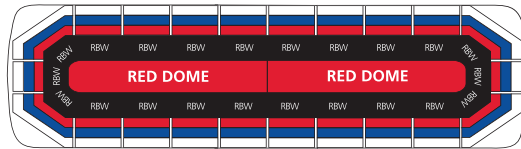

RLNT48J-02RR

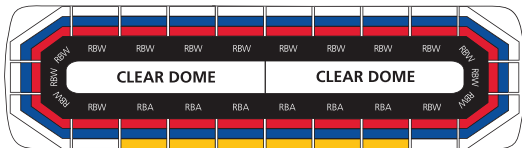

RLNT48J-01CC

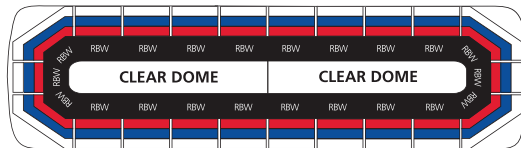

RLNT48J-02CC

Distributed by Gross Automation | +1 (262) 252-1600 | sales@grossautomation.com



For the most up-to-date hook mount information, visit [www.fedsig.com/hook-mount-reference-guide](http://www.fedsig.com/hook-mount-reference-guide).

MAKE/MODEL	YEAR	HOOK KIT MODEL #	ROOF WIDTH	CAB STYLE
<b>Ford</b>				
Bronco Sport	2021-25	HKB-BCS21	N/A	
E-Series Van/Cutaway	1975-2026	HKB-SAV	65.0"	
Edge	2015-24	HKB-UNH4	51.8"	
Escape (No Roof Rack Rails)	2020-26	HKB-ESC20	45.0"	
Expedition (No Roof Rack) light bar lengths 51, 53-in	2018-26	HKB-EXD22	55.5"	
F-150 Responder light bar lengths 44, 45, 46, 48-in	2015-26	HKB-FRD15-44-HP	55.5"	All
F-150 Responder light bar lengths 51, 53-in with standard height foot	2015-26	HKB-FRD15-HP	55.5"	All
F-150 Responder light bar lengths 51, 53-in with low-profile foot	2015-26	HKB-FRD15-44-HP	55.5"	All
F-150 light bar lengths 44, 45, 46, 48-in	2015-26	HKB-UNH6	55.5"	All
F-150 light bar lengths 51, 53-in with standard height foot	2015-26	HKB-UNH5	55.5"	All
F-150 light bar lengths 51, 53-in with low-profile foot	2015-26	HKB-UNH6	55.5"	All
F-250/350/450/550 All light bar lengths	2017-26	HKB-UNH6	55.5"	All
F-650/750 light bar lengths 51, 53, 60-in	2017-26	HKB-FHD7	58.5"	All
Maverick	2022-26	HKB-MAV22	50.5"	
Mustang Mach-E (Without Panoramic roof opt.)	2021-26	HKB-MME21	N/A	
Mustang	2012-26	Permanent Mount	46.0"	
Police Interceptor Utility/Explorer light bar lengths 44, 45, 46-in (No Rack)	2020-26	HKB-FPIU20-HP	52.8"	
	2020-26	HKB-FPIU20-LONG-HP	52.8"	Valor/Vision w/std foot
Police Interceptor Utility/Explorer light bar lengths 48, 51, 53-in (No Rack)	2020-26	HKB-FPIU20-HP	52.8"	
Police Interceptor Utility/Explorer light bar length 44-in	2020-2026	HKB-FPIU20-44-HP	52.8"	Valor with low-profile foot
Ranger	2019-23	HKB-RNG19	48.0"	Super
	2024-26	HKB-RNGR24	46.7"	
Transit (Low Roof) 60-in light bars only	2015-26	HKB-UNH4	N/A	
Transit (Raised Roof)	2015-26	Permanent Mount	67.5"	
<b>Chevrolet/GM</b>				
Blazer EV	2024-25	HKB-BLZR24	53.0"	
Camaro	2011-23	Permanent Mount	50.0"	
Colorado/Canyon	2015-24	HKB-COL15	47.3"	All
Express/Savana Van	2001-26	HKB-SAV	61.0"	
Malibu	2012-23	HKB-UNH1	48.0"	
Silverado/Sierra (1500) light bar lengths 44, 45, 46-in	2019-26	HKB-UNH3	52.0"	All
	2014-18	HKB-UNH4	55.8"	
Silverado PPV light bar lengths 44, 45, 46-in	2022-26	HKB-TAH21-44-HP	52.0"	All
Silverado/Sierra (1500) light bar lengths 51, 53-in	2019-26	HKB-UNH2	52.0"	All
	2014-18	HKB-SIL17	55.8"	
Silverado PPV light bar lengths 51, 53-in	2022-26	HKB-TAH21-HP	52.0"	All
Silverado/Sierra (2500, 3500) light bar lengths 44, 45, 46-in	2019-26	HKB-UNH2	55.0"	All

MAKE/MODEL	YEAR	HOOK KIT MODEL #	ROOF WIDTH	CAB STYLE
Silverado/Sierra (2500, 3500) light bar lengths 51, 53-in	2019-26	HKB-UNH3	55.0"	All
Tahoe/Suburban (No Roof Rails) light bar lengths 44, 45, 46, and 48-in	2021-26	HKB-TAH21-44-HP	55.0"	
	2015-20	HKB-UNH4	55.0"	
Tahoe/Suburban (No Roof Rails) light bar lengths 51, 53-in	2021-26	HKB-TAH21-HP	55.0"	
	2015-20	HKB-LPCHGR11-HP	55.0"	
Traverse (No rack)	2018-23	HKB-TRAV22	53.0"	
<b>Chrysler/Dodge/Jeep</b>				
Challenger	2012-23	Permanent Mount	54.5"	
Charger	2011-23	HKB-LPCHGR11-HP	50.3"	
Durango (No Roof Rack)	2011-26	HKB-DUR11B-HP	54.0"	
Grand Cherokee (No Roof Rack)	2011-20	HKB-DUR11B-HP	54.0"	
RAM 1500	2019-26 (5th Gen)	HKB-RAM19	55.0"	All
RAM 1500 SSV	2025-26	HKB-RAM19	55.0"	All
RAM 1500 Classic/SSV	2019-24 (4th Gen)	HKB-FRD9	57.5"	
RAM 2500, 3500, 4500	2010-26	HKB-FRD9	57.5"	
Wrangler	2012-26	Permanent Mount	N/A	
<b>Toyota</b>				
RAV4 (with Roof Rails)	2025	HKB-RAV25RR	43.0"	
RAV4 (No Roof Rails)	2023-24	HKB-RAV23	43.0"	
RAV4	2018-22	HKB-UNH1	N/A	
4-Runner	2022-24	HKB-DUR11B-HP	53.0"	
	2016-23	HKB-UNH1	N/A	
Tacoma	2024-25	HKB-TAC24	N/A	
	2022-24	HKB-RAM19	N/A	
<b>Nissan</b>				
Frontier	2022-23	HKB-FNTR	53.0"	
Leaf	2015-23	HKB-UNH1	N/A	
Rogue (No Roof Rails)	2021-25	HKB-ROG23	51.0"	
Titan	2023-24	HKB-TTN23	58.0"	
<b>International</b>				
Durastar/4300 cab	2002-18	HKB-FHD7	65.8"	

All Federal Signal light bars may be permanent or hook-on mounted. When using a hook-on mount, a separate hook kit is required for the make, model and year of your vehicle. Use the hook kit reference guide to find your vehicle's appropriate hook kit. Measurements for the roof width are determined by the style of the vehicle. These measurements may help you in choosing the light bar length best suited for your vehicle.

**Transfer of Light Bars From One Vehicle to Another**

From time to time, departments will remove a light bar from an older vehicle and reinstall it on a newer vehicle. Before performing this kind of transition, be sure to contact our Service Department to ensure that you not only have the proper hook kit, but that you also have the latest design light bar mount foot. Mounting foot designs continuously improve over time, and it is recommended that you utilize the most current mount foot design when reinstalling an older light bar on a newer vehicle.

**Note**

The hook kit reference guide is updated on an ongoing basis as information becomes available. Please check the hook kit reference guide online at [www.fedsig.com/hook-mount-reference-guide](http://www.fedsig.com/hook-mount-reference-guide) for up-to-date vehicle and hook kit listings.

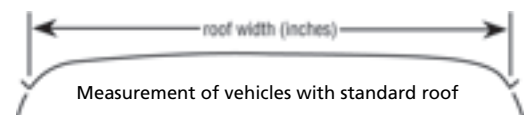
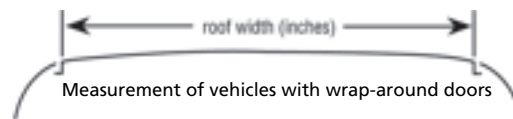

Distributed by Gross Automation | +1 (262) 252-1600 | sales@grossautomation.com

# 21" Allegiant®



- Low-profile, 21" mini-light bar
- Single- and dual-color capability
- Serial models available with front flood, rear-flood, takedowns, alley lights, work lights, bed light, and cruise
- Discrete models available with takedowns, work lights, and bed light
- Low-power mode
- (29) flash patterns
- 12 Vdc
- Flat, low-profile permanent, magnet, and 4" riser mounting options







**LED COLOR OPTIONS**  











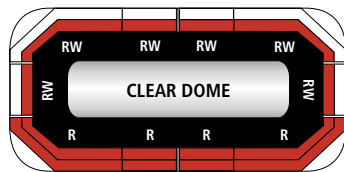

MODEL	LENGTH	WARNING LIGHT CAPABILITY	FLOOD LIGHTS	TD/ALLEY LIGHTS	DOMES COLOR	MOUNT	DISCRETE
ALGT21J-FIRE1	21-inch	Red/White	•	•	Clear	Low-Profile Permanent	
ALGT21D-FIRE1	21-inch	Red/White		Takedowns only	Clear	Low-Profile Permanent	•
ALGT21D-NFPA20D	21-inch	Red/White		Takedowns only	Clear	Low-Profile Permanent	•
ALGT21D-NFPA20P	21-inch	Red/White		Takedowns only	Clear	Low-Profile Permanent	•
ALGT21D-NFPA21	21-inch	Red/White		Takedowns only	Clear	Low-Profile Permanent	•
ALGT21D-NFPA22	21-inch	Red			Clear	Low-Profile Permanent	•

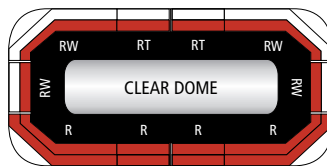

ALGT21J-FIRE1

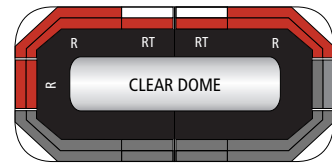

ALGT21D-FIRE1



ALGT21D-NFPA20D

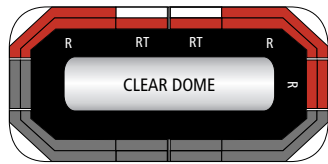

ALGT21D-NFPA20P

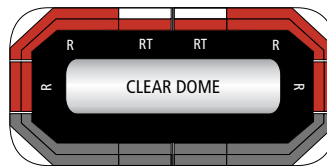

ALGT21D-NFPA21

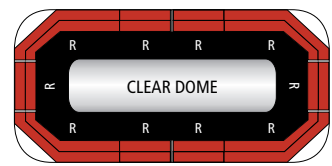

ALGT21D-NFPA22

Distributed by Gross Automation | +1 (262) 252-1600 | sales@grossautomation.com













Effective January 19, 2026

# HighLighter® Micro

- Low-profile, 10" mini-light bar
- Single- and split-color models
- (25) flash patterns
- Multi-voltage, 12/24 Vdc
- Permanent, suction-cup, and magnet mount options





**LED COLOR OPTIONS**









MODEL	DESCRIPTION
<b>Permanent mount</b>	
HL10PC-R	Permanent mount, single-color, Red LEDs, Clear dome, -A (Amber); -B (Blue); -G (Green); -W (White)
HL10PC-AR	Permanent mount, split-color, Amber/Red LEDs, Clear dome, -AB (Amber/Blue); -AG (Amber/Green); -AW (Amber/White); -RB (Red/Blue)
<b>Magnet mount, accessory plug, on/off switch</b>	
HL10MC-R	Magnet mount, single-color, Red LEDs, Clear dome, -A (Amber); -B (Blue); -G (Green); -W (White)
HL10MC-AR	Magnet mount, split-color, Amber/Red LEDs, Clear dome, -AB (Amber/Blue); -AG (Amber/Green); -AW (Amber/White)
<b>Suction-cup magnet mount, accessory plug, on/off switch</b>	
HL10SC-R	Suction-cup magnet mount, single-color, Red LEDs, Clear dome, -A (Amber); -B (Blue); -G (Green); -W (White)
HL10SC-AR	Suction-cup magnet mount, split-color, Amber/Red LEDs, Clear dome, -AB (Amber/Blue); -AG (Amber/Green); -AW (Amber/White)

# HighLighter® Elite

- Low-profile, 15" mini-light bar
- Single-, split-, and dual-color models
- Unique edge cruise lighting available in dual-color models
- (25) flash patterns
- Multi-voltage, 12/24 Vdc
- Permanent, suction-cup, and magnet mount options







**LED COLOR OPTIONS**









MODEL	DESCRIPTION
<b>Permanent mount</b>	
HL15PC-R	Permanent mount, single-color, Red LEDs, Clear dome, -A (Amber); -B (Blue); -G (Green); -W (White)
HL15PC-AR	Permanent mount, dual-color, Amber/Red LEDs, Clear dome, -AB (Amber/Blue); -AG (Amber/Green); -AW (Amber/White); -BW (Blue/White); -RB (Red/Blue); -RW (Red/White)
<b>Magnet mount, accessory plug, on/off switch</b>	
HL15MC-R	Magnet mount, single-color, Red LEDs, Clear dome, -A (Amber); -B (Blue); -G (Green); -W (White)
HL15MC-AR	Magnet mount, dual-color, Amber/Red LEDs, Clear dome, -AB (Amber/Blue); -AG (Amber/Green); -AW (Amber/White); -BW (Blue/White); -RB (Red/Blue); -RW (Red/White)
<b>Suction-cup magnet mount, accessory plug, on/off switch</b>	
HL15SC-R	Suction-cup magnet mount, single-color, Red LEDs, Clear dome, -A (Amber); -B (Blue); -G (Green); -W (White)
HL15SC-AR	Suction-cup magnet mount, dual-color, Amber/Red LEDs, Clear dome, -AB (Amber/Blue); -AG (Amber/Green); -AW (Amber/White); -BW (Blue/White); -RB (Red/Blue); -RW (Red/White)

Distributed by Gross Automation | +1 (262) 252-1600 | sales@grossautomation.com

# SpectraLux® ILS Low-Profile



Center-Focused Board

- Slim interior light available as Center-Focused and Advanced Off-Axis
- Single-, dual-, or tri-color capability
- Split-front, passenger front, rear hatch, rear deck, and rear window models
- (26) flash patterns
- 12 Vdc
- Shrouds and mounting kits available for a variety of vehicles

**LED COLOR OPTIONS**

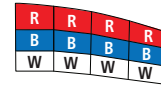
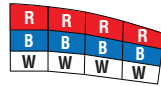
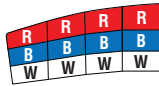

## SIFMJ Split-front Models

VEHICLE	YEAR	MODEL
Ford Escape	2020-2026	SIFMJS-ESC20-P3
Ford Expedition	2018-2025	SIFMJS-EXPD18-P3
Ford Mustang Mach-E	2021-2025	SIFMJS-MME21-P3
Ford Mustang	2019-2023	SIFMJS-MUST19-P3
Ford Police Interceptor Utility	2020-2026	SIFMJS-FPIU25-P3
Ford F-150	2015-2025	SIFMJS-FD15-P3
Ford Lightning	2022-2025	SIFMJS-FD15-P3
Ford Maverick	2024-2025	SIFMJS-MAV24-P3
Chevrolet Blazer EV	2024-2025	SIFMJS-BZEV-P3
Chevrolet Camaro	2016-2023	SIFMJS-CAM16-P3
Chevrolet Express	2018-2025	SIFMJS-EXPR18-P3
Chevrolet Malibu	2017-2024	SIFMJS-MAL16-P3
Chevrolet Silverado 1500	2019-2025	SIFMJS-SIL25-P3
Chevrolet Tahoe	2021-2025	SIFMJS-TAH21-P3
Toyota Camry	2020-2025	SIFMJS-CMR22-P3
Jeep Grand Cherokee	2025-2026	SIFMJS-JGC25-P3
Dodge Charger	2016-2023	SIFMJS-CHGR16-P3
Dodge Durango	2016-2026	SIFMJS-DUR16-P3
Multi-Vehicle	—	SIFMJS-UNIV-P3

## SIFMJ Front Passenger Models

VEHICLE	YEAR	MODEL
Ford Escape	2020-2026	SIFMJP-ESC20-P3
Ford Mustang Mach-E	2021-2026	SIFMJP-MME21-P3
Chevrolet Camaro	2016-2023	SIFMJP-CAM16-P3
Chevrolet Express	2018-2025	SIFMJP-EXPR18-P3
Toyota Camry	2020-2025	SIFMJP-CMR22-P3

## SIFMJD Front Driver Models

VEHICLE	YEAR	MODEL
Ford Mustang	2024-2025	SIFMJD-MUST24-P3

**Note**

- \*Visit our online configurator to configure your custom SpectraLux ILS Low-Profile.

Distributed by Gross Automation | +1 (262) 252-1600 | sales@grossautomation.com



Effective January 19, 2026

SpectraLux® ILS Low-Profile— Continued

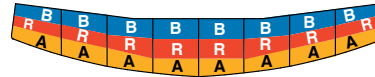

SIFMJ Rear Hatch/Rear Deck/Rear/Upper Rear Window Models

VEHICLE	YEAR	MODEL
Ford Expedition	2025	SIFMJH-EXPD25-P3
Ford Mustang Mach-E	2021-2025	SIFMJH-MME21-P3
Ford Mustang	2019-2023	SIFMJR-MUST19-P3
Ford Mustang	2024-2025	SIFMJUR-MUST24-P3
Ford Police Interceptor Utility	2020-2026	SIFMJH-FPIU20-P3
Ford F-150	2015-2025	SIFMJR-FD15-P3
Chevrolet Blazer EV	2024-2025	SIFMJH-BZEV-P3
Chevrolet Camaro	2016-2024	SIFMJR-CAM16-P3
Chevrolet Tahoe	2021-2025	SIFMJH-TAH21-P3
Dodge Charger	2016-2023	SIFMJR-CHGR17-P3
Dodge Durango	2016-2026	SIFMJH-DUR18-P3
Jeep Grand Cherokee	2025-2026	SIFMJH-JGC25-P3

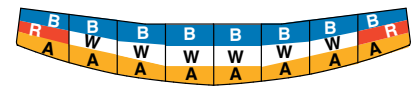
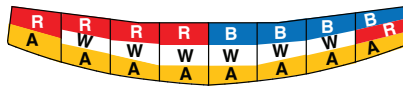

OBD Integrated SIFMJ Rear Deck/Rear Hatch/Rear Window Models

VEHICLE	YEAR	MODEL	MODEL
Ford Police Interceptor Utility	2020-2026	SIFMJH-FPIU20-PF1	SIFMJH-FPIU20-PF2
Ford F-150	2015-2025	SIFMJR-FD15-PF1	SIFMJR-FD15-PF2
Chevrolet Tahoe	2021-2025	SIFMJH-TAH21-PF1	SIFMJH-TAH21-PF2
Dodge Charger	2017-2023	SIFMJR-CHGR17-PF1	SIFMJR-CHGR17-PF2
Dodge Durango	2018-2026	SIFMJH-DUR18-PF1	SIFMJH-DUR18-PF2

Note

- \* Visit our online configurator to configure your custom SpectraLux ILS Low-Profile.



Distributed by Gross Automation | +1 (262) 252-1600 | sales@grossautomation.com

# Siren Feature Comparison

	PATHFINDER® PF400	PATHFINDER® PF200	PATHWAY™	PA300	PA300-100	PA4000
Total Output Wattage	400 W	200 W	100 W	200 W	100 W	200 W
FS Convergence Network	•	•	•		•	•
FSJoin®	•	•	•			•
Air Horn	•	•	•	•	•	•
PA (Public Address)	•	•	•	•	•	•
Siren Tones	•	•	•	•	•	•
Remote Control Head	•*	•*	•*			•
Slide Switch	•*	•*	•*			
Lighting Control	•	•	•		•†	•
SignalMaster™ Control	•	•	•			•
Microphone	•	•	•	•	•	•
Built-in Timer Feature	•	•	•		•	•
Programmable Inputs & Outputs	•	•	•		•**	•
Load Management	•	•	•			•
FS Vehicle Integration/OBD Integration	•	•				•
Integrated Dual-Tone	•	•				•
Integrated Rumbler® Traffic-Clearing Capability	•	•				•
Rotary Switch	•*	•*	•*	•	•	•
Warranty (years)	5	5	5	3	5	5

\* Select Models

\*\* Inputs only

† Through Convergence Network ports only

Distributed by Gross Automation | +1 (262) 252-1600 | sales@grossautomation.com



Effective January 19, 2026

# Q-Siren®

- Streamlined and polished electro-mechanical siren
- Distinct sound provides recognizable, long-distance warning
- Utilizes a unique clutch design that provides a longer coast-down sound while reducing the amperage draw
- Available in traditional Chrome or Black Chrome



Siren tones available online



MODEL	DESCRIPTION
Q2B-012NNSD	Q2B, mechanical siren, Chrome, recess mount
Q2B-012PSD	Q2B, mechanical siren, Chrome, pedestal mount
Q2B-NN-BLK	Q2B, mechanical siren, Black Chrome, recess mount
Q2B-P-BLK	Q2B, mechanical siren, Black Chrome, pedestal mount
<b>KITS</b>	
Q-MT	Kit, Q2B, bracket for recess mounting Q2B siren
Q2B-SWKIT	Kit, Q2B, Solenoid and Foot Switch
<b>COMMON REPLACEMENT PARTS</b>	
Z8280080B	Motor, Q2B siren
Z828000641	Clutch assembly
Z8280104B	Front grille, Q2B siren; -BC (Black Chrome)
Z8280106A	Stator guard, Q2B siren; -BC (Black Chrome)
Z8280B003J-02	Brake assembly
Z8280C077A	Mounting base, Q2B siren, polished stainless steel; -BC (Black Chrome)
ZH5205-03	Rear housing, Q2B siren, polished stainless steel; -BC (Black Chrome)



Distributed by Gross Automation | +1 (262) 252-1600 | sales@grossautomation.com

# Pathfinder® PF400



- 400 W Programmable siren/light controller with remote-mount amplifier
- (4) 100 W independent audio channels
- Integrated multi-tone capability
- Integrated Rumbler® traffic-clearing capability
- Capable of Rumbler and dual-tone in a single amplifier
- PF400Q models feature the traditional trademarked Q-Siren tone
- FS Vehicle Integration/On-Board Diagnostics Integration (OBDII)
- Library of selectable siren tones
- (4) FS Convergence Network ports
- (7) programmable inputs and (16) programmable solid-state outputs
- Standard voice messages are available in English, Spanish, and French Canadian to broadcast alerts. Custom voice messages available for an additional fee
- Convergence Network Configuration Software allows easy customization of siren and light controls

Convergence Network

FSJoin

Rumbler

Q-Siren Sound

Siren tones and voice messages available online

WARRANTY  
5 YEARS

MODEL	DESCRIPTION
PF400Q	Siren/Light Controller with Remote surface mount controller, 400 W, integrated Q-tone
PF400QS17B	Siren/Light Controller with 17-button controller, 400 W, integrated Q-tone
PF400QS17BRK	Siren/Light Controller with 17-button and rotary knob controller, 400 W, integrated Q-tone
PF400QH	Siren/Light Controller with Handheld controller/microphone, 400 W, integrated Q-tone
PF400QR	Siren/Light Controller with Remote surface mount controller, 400 W, integrated Q-tone
PF400QS13	Siren/Light Controller with 13-button controller, 400 W, Integrated Q-tone
PF400QAMP	PF400Q Amplifier, no controller, integrated Q-tone

## CONTROLLER OPTIONS



**PF400Q**  
Remote Surface-mount Controller with (4) Push-buttons and Rotary Knob



**PF400QR**  
(9) Push-buttons, Rotary Knob, and Slide Switch



**PF400QH**  
Handheld Controller / Microphone with (14) Push-buttons



**PF400QS17B**  
Remote Surface-mount Controller with (17) Push-buttons and Slide Switch



**PF400QS17BRK**  
Remote Surface-mount Controller with (17) Push-buttons, Rotary Knob, and Slide Switch



**PF400QS13**  
Remote Surface-mount Controller with (13) Push-buttons

Distributed by Gross Automation | +1 (262) 252-1600 | sales@grossautomation.com

# Pathfinder® PF200

- 100/200 W siren and light controller with PA and noise-canceling microphone
- Integrated dual-tone capability when used with (2) speakers
- Integrated Rumbler® traffic clearing capability
- Optional FS Vehicle Integration/On-Board Diagnostics Integration (OBDII)
- Library of selectable siren tones includes SmartSiren®, Unitrol™, PA300, and Powercall® siren tones
- (7) programmable inputs and (12) programmable solid-state relay outputs
- Convergence Network Configuration Software allows easy customization of siren and light controls
- (2) FS Convergence Network ports
- Standard digital voice messages are available in English, Spanish, and French Canadian to broadcast alerts. Custom digital voice messages are available for an additional fee



MODEL	DESCRIPTION
PF200	Siren/Light Controller with self contained controls, 100/200 W
PF200R	Siren/Light Controller with Remote surface mount controller, 100/200 W
PF200H	Siren/Light Controller with Handheld controller/microphone, 100/200 W
PF200S17B	Siren/Light Controller with 17-button controller, 100/200 W
PF200S17BRK	Siren/Light Controller with 17-button and rotary knob controller, 100/200 W
PF200S13	Siren/Light Controller with 13-button controller, 100/200 W
PF200S6	Siren/Light Controller with 6-button controller, 100/200 W
PF200S4	Siren/Light Controller with 4-button controller, 100/200 W
PF200AMP	Pathfinder Amplifier, no controller

## CONTROLLER OPTIONS



PF200



PF200H



PF200R



PF200S17B



PF200S6



PF200S4



PF200S17BRK



PF200S13



Distributed by Gross Automation | +1 (262) 252-1600 | sales@grossautomation.com

**PATHFINDER® ACCESSORIES**

**ACCESSORIES**

PFSYNC-1	On Scene Sync Module
RBKIT-SOLO*	Single Rumbler Solo low frequency speaker for use with sirens with integrated Rumbler capability
RBKIT2-COMPACT*	Pair of Rumbler Compact low frequency speakers for use with sirens with integrated Rumbler capability
PBW-SYSTEM	Perimeter Breach Warning System
PBWK-FPIU20	Perimeter Breach Warning System mounting kit, Ford Police Interceptor Utility, 2020-2025
PBWK-TAH21	Perimeter Breach Warning System mounting kit, Chevrolet Tahoe, 2021-2025
PBWK-DUR23	Perimeter Breach Warning System mounting kit, Dodge Durango, 2023-2025
PFPDM-1	Power Distribution Module, 100 A max load
EXPMOD24	24-Channel Expansion Module
EXPMOD32	32-Channel Expansion Module
EXPMOD-2	Rear Expansion Module, (18) solid-state programmable relay outputs, (16) 7.5 A flashing outputs and (2) 20 A control outputs
EXPHARN01	Rear taillight connection wire harness for use with rear expansion module, Dodge Charger Pursuit, 2015-2023
EXPHARN03	Rear taillight connection wire harness for use with rear expansion module, Ford Police Interceptor Utility, 2020-2025
EXPHARN04	Rear taillight and rear liftgate lighting connection wire harness for use rear expansion module, Dodge Durango, 2018-2025
EXPHARN05	Rear taillight connection wire harness for use with rear expansion module, Chevrolet Tahoe, 2021-2024
EXPHARN06	Rear taillight connection wire harness for use with rear expansion module, Ford Police Interceptor Utility, 2020-2025
EXPHARN07	Rear taillight connection wire harness for use with rear expansion module, Chevrolet Tahoe, 2025+
PFSPLTR-4	4-to-1 splitter
RMK-PF400	RJ11 microphone, extension cable

**COMMON REPLACEMENT PARTS**

Z258B577D-03	RJ11 microphone
MNCT-SD	1/4-inch Jack microphone, PF200 only
Z862302765A	Replacement Controller, PF200H/PW100H/PF400H/PF400QH
Z862303172A	Replacement Controller, PF200S17B/PF400S17B/PF400QS17B
Z862304788A	Replacement Controller, PW100S13/PF200S13/PF400QS13
Z8623129A	Swivel Mount, PF200H/PW100H/PF400H/PF400QH
Z862302763A	Mounting bracket, PF200H/PW100H/PF400H/PF400QH
Z1751357A-06	CAT5 Cable — Coupler to Amplifier, 8-ft
Z1751357A-02	CAT5 Cable — Control Head to Coupler, 25-ft
Z17501359A	Relay output pigtail
Z13901850A	RJ45 Coupler
Z17501849A	Wire Assembly — RJ45 Coiled
Z71401783A	Legend stickers

**RUMBLER® INTEGRATION**

Pathfinder is available with built-in Rumbler traffic-clearing capability. With Rumbler, the Pathfinder produces a Rumbler tone without the need for a separate externally-mounted amplifier.

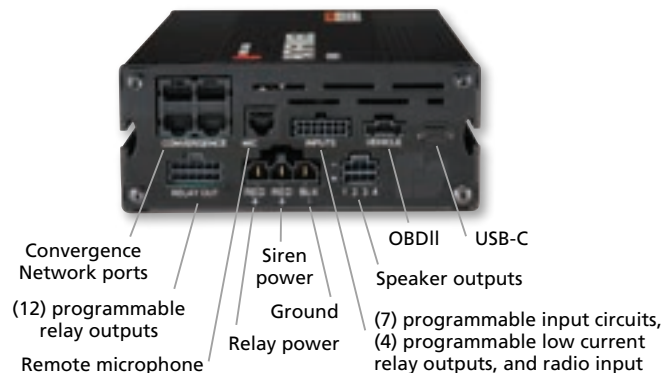

Distributed by Gross Automation | +1 (262) 252-1600 | sales@grossautomation.com

# RUMBLER®, MULTI-TONE, AND PERIMETER BREACH WARNING CAPABILITIES FOR MAXIMUM RESPONSE

When responding to a call, safety is the number one priority. Pathfinder® comes through with built-in Rumbler® traffic clearing capability and Multi-tone integration to clear traffic where you need it most.

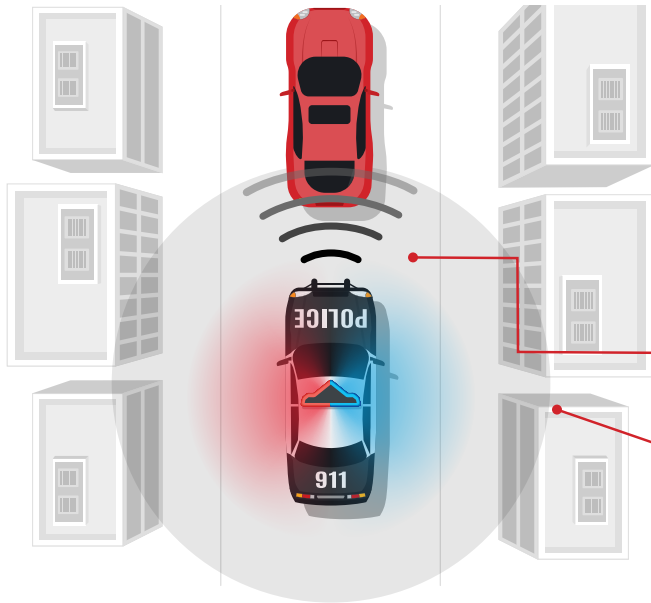

## RUMBLER®

Rumbler® low frequencies deliver up to 10dB more sound pressure inside civilian vehicles near your emergency vehicle—getting attention and clearing traffic more effectively than a standard siren tone.

*Sound pressure varies based on vehicle type and distance.*

Low frequency tones work simultaneously with primary siren—penetrating nearby vehicles.

Particularly effective for Police and Fire/EMS applications in dense urban environments with heavy vehicle traffic.

## MULTI-TONE

Multi-Tone provides a 50% increase in audible warning distance vs. a single-speaker/single-tone system creating the perception of a multi-vehicle, emergency response ideal for highway patrol.

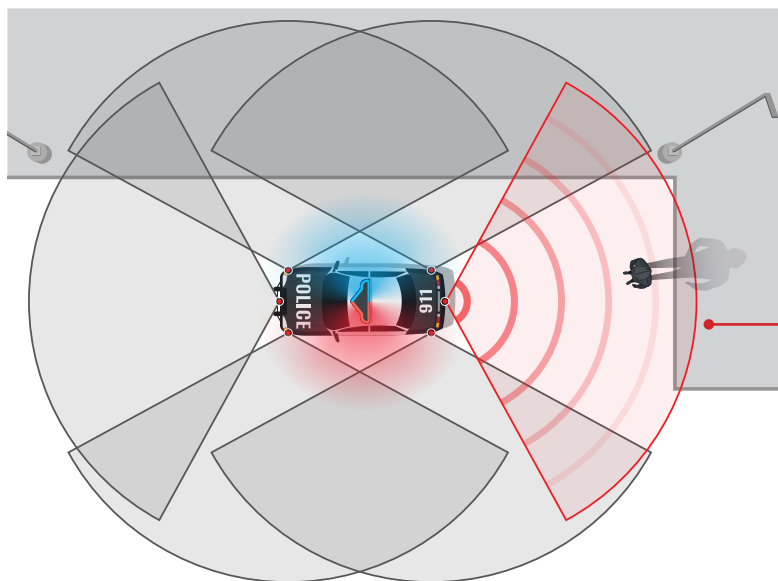
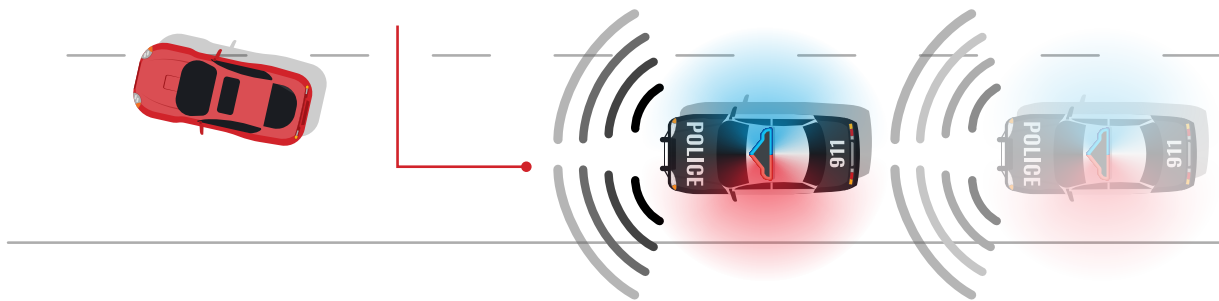

## PERIMETER BREACH WARNING

Perimeter Breach Warning provides a minimum 25-foot activation zone for audible and visual alerts, enhancing situational awareness.

# Pathfinder® OBD Cable Vehicle Reference Chart

VEHICLE	YEARS	OBDCABLE6-1 (6')/ OBDCABLE25-1 (25')	OBDCABLE8-6 (8-FT)/ OBDCABLE20-6 (20-FT)	OBDCABLE6-DGCAN (6')/ OBDCABLE25-DGCAN (25')	OBDCABLE8-GMCAN (8')/ OBDCABLE20-GMCAN (20')	OBDCABLE8-4 (8')/ OBDCABLE20-4 (20')	OBDCABLE4-5 (4')/ OBDCABLE20-5 (20')	OBDCABLE16-7 (16')
<b>CHEVROLET</b>								
Blazer EV	2024-2026						•	
Camero	2021-2023	•						
Equinox	2025-2026						•	
Silverado EV	2024-2026						•	
Silverado 1500	2023-2026						•	
Silverado 2500/3500	2023-2026						•	
Tahoe/Suburban	2018-2020	•						
	2021-2025				•		•	
Traverse	2025-2026						•	
<b>DODGE</b>								
Challenger	2018-2023			•				
Charger	2018-2024			•				
Durango	2016-2026			•				
Ram 1500	2025-2026***			•				
Ram 2500	2025-2026***			•				
Ram 3500	2025-2026***			•				
<b>FORD</b>								
Escape	2023-2026		•					
	2020-2024		•					
Expedition	2025-2026***			•				
F-150	2024-2025		•					
F-150 Lightning	2022-2026		•			•		
F-250 F-350 F-450 F-550	2023-2026***			•				
Mustang	2024-2026		•					
Mustang Mach-E	2021-2026		•			•		
Police Interceptor Utility	2025-2026							•
Ranger	2024-2026		•					
Transit*	2020-2026							•
<b>JEEP</b>								
Cherokee	2019			•				
Wrangler	2020-2026***			•				
Grand Cherokee	2025-2026***			•				
<b>GMC</b>								
Acadia	2025-2026						•	
Yukon	2021-2025				•		•	
Sierra 1500	2023-2026						•	
Sierra 2500/3500	2023-2026						•	

**Notes**

- \* Models equipped with 4" or 8" entertainment screen only
- \*\*\* Cable must be hard-wired





Distributed by Gross Automation | +1 (262) 252-1600 | sales@grossautomation.com



# Pathway™

- 100 W siren and light controller with PA and noise-canceling microphone
- Library of selectable siren tones includes SmartSiren®, Unitrol™, PA300 and Powercall® siren tones
- (7) programmable inputs and (12) programmable solid-state relay outputs
- Convergence Network Configuration Software allows easy customization of siren and light controls
- (2) FS Convergence Network ports
- Standard digital voice messages available in English, Spanish and French Canadian to broadcast alerts; custom digital voice messages available for an additional fee

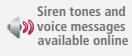

 Convergence Network	 FSJoin.	 Siren tones and voice messages available online	 WARRANTY 5 YEARS
---	---	---	--

MODEL	DESCRIPTION
PW100	Siren/light controller with self-contained controls, 100 W
PW100R	Siren/light controller with remote surface mount controller, 100 W
PW100H	Siren/light controller with handheld controller/microphone, 100 W
PW100S13	Siren/light controller with Thirteen-button controller
PW100S6	Siren/light controller with Six-button controller, 100 W
PW100S4	Siren/light controller with Four-button controller, 100 W
<b>ACCESSORY</b>	
PFSYNC-1	On Scene Sync Module

## CONTROLLER OPTIONS



**PW100**  
(9) Push-buttons, Rotary Knob, and Slide Switch



**PW100H**  
Handheld Controller / Microphone with (14) Push-buttons



**PW100R**  
(9) Push-buttons, Rotary Knob, and Slide Switch



**PW100S6**  
Remote Surface-mount Controller with (6) Push-buttons and Slide Switch



**PW100S4**  
Remote Surface-mount Controller with (4) Push-buttons



**PW100S13**  
Remote Surface-mount Controller with (13) Push-buttons



Distributed by Gross Automation | +1 (262) 252-1600 | sales@grossautomation.com

# PA300

- Full-featured siren in a compact package
- Easy-to-operate and durable switching
- Built-in noise-canceling microphone
- Illuminated, non-glare control panel
- External PA Gain control
- Easily accessible fuse protection
- Effective TAP II intersection clearing
- Priority in place of hi-lo tone available
- 12 Vdc or 24 Vdc models available



Siren tones available online



MODEL	DESCRIPTION
690009	200 W, PA300-024MSC, hi-lo tone, hard-wired microphone, 24 Vdc
690010	200 W, PA300-012MSC, hi-lo tone, hard-wired microphone
<b>ACCESSORIES AND KITS</b>	
761300	Kit, PA300 Series, adapter cable harness converts to new 690000 PA300 design
MNCT-SD	Microphone, noise-canceling, PA/Radio
DSM	Kit, PA300 Series, bezel for dash mount
<b>COMMON REPLACEMENT PARTS</b>	
Z122377A	Switch, 690 Series, air horn
Z141A102	Knob, PA300, gain control
Z141A111	Knob, PA300, function/tone selector
Z1461360A	Wire harness, 690 Series, 4-ft length, 12 Vdc
Z8537561A	Accessory kit, connectors, bracket, hardware

# PA300-100

- 100 W siren with PA and noise-canceling microphone
- Library of selectable siren tones
- (4) programmable inputs, plus dedicated inputs for park, horn, and ignition
- Convergence Network Configuration Software allows easy customization of the siren
- (2) FS Convergence Network ports
- Standard voice messages available in English, Spanish, and French Canadian to broadcast alerts; custom voice messages available for an additional fee



Siren tones and voice messages available online



MODEL	DESCRIPTION
PA300-100	Siren with self-contained controls, 100 W







Distributed by Gross Automation | +1 (262) 252-1600 | sales@grossautomation.com

# PA4000

- 200 W siren and light controller with PA and noise-canceling microphone
- Flush mount controller with remote amplifier
- Integrated dual-tone capability when used with (2) speakers
- Integrated Rumbler® traffic clearing capability
- Library of selectable siren tones includes SmartSiren®, Unitrol™, and Powercall® siren tone
- Optional FS Vehicle Integration/On Board Diagnostics Integration (OBDII)
- Convergence Network Configuration Software allows for easy customization of siren and light controls
- (7) programmable inputs and (12) programmable solid-state relay outputs
- (2) FS Convergence Network ports
- Standard voice messages available in English, Spanish, and French Canadian to broadcast alerts; custom voice messages available for an additional fee

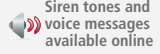

 Convergence Network	 FSJoin.	 Rumbler.	 Siren tones and voice messages available online	 5 YEAR WARRANTY
---	---	--	---	---

MODEL	DESCRIPTION
PA4000-200	200 W, flush mount control, remote amplifier

# Rumbler®

- Rumbler low frequencies deliver up to 10 dB more sound pressure inside civilian vehicles near emergency vehicle — getting attention and clearing traffic more effectively than a standard siren tone
- Low-frequency tones work simultaneously with primary siren
- Produces penetrating/vibrating low-frequency sound waves
- Interacts with most 100/200 W emergency vehicle siren amplifiers
- Highly effective in dense urban environments with heavy vehicle traffic
- Rumbler low-frequency speakers work in conjunction with Federal Signal sirens that feature integrated traffic-clearing capability
- Rumbler low frequency speakers are also available with Rumbler amplifier to work with other Federal Signal sirens



RBKIT2-COMPACT



RBKIT-SOLO



MODEL	DESCRIPTION
RBKIT2-COMPACT	Pair of Rumbler Compact low frequency speakers for use with sirens with integrated Rumbler capability
RBKIT1-COMPACT	Single Rumbler Compact low frequency speaker for use with sirens with integrated Rumbler capability
RBKIT-SOLO	Single Rumbler Solo low frequency speaker for use with sirens with integrated Rumbler capability
RUMBLER-C2	Rumbler Amp, Pair of Rumbler Compact low frequency speakers and hardware kit
RUMBLER-SOLO	Rumbler Amp, Single Rumbler Solo low frequency speaker and hardware kit
<b>ACCESSORY</b>	
RB-SW	Rumbler activation switch

**Note**

- Vehicle-specific Rumbler brackets sold separately and can be found on page 29

Distributed by Gross Automation | +1 (262) 252-1600 | sales@grossautomation.com



**RUMBLER® BRACKETS**



RBS-FPIU20ND

Single Rumbler Solo or Single Compact, no drill, passenger side bracket, Ford Police Interceptor Utility, 2020-2025



RBC-FPIU25ND

(1) Compact, no drill, passenger side bracket. Compatible with DFC Series Push Bumper lower guard, Ford Police Interceptor Utility, 2020-2025



RBC2-FPIU25ND

(2) Compact, no drill, (1) passenger side bracket and (1) driver side bracket. Compatible with DFC Series Push Bumper lower guard, Ford Police Interceptor Utility, 2020-2025



RBS-TAH21ND

Single Rumbler Solo or (1) Compact, no drill, passenger side bracket, Chevrolet Tahoe, 2021-2025 and Chevrolet Silverado 1500, 5.3L V8 only, no turbo, 2019-2025



RBC2-TAH21ND

Pair of Compact speakers, no drill, (1) passenger side bracket and (1) driver side bracket, Chevrolet Tahoe, 2021-2025 and Chevrolet Silverado 1500, 5.3L V8 only, no turbo, 2019-2025



RBS-DUR23ND

Single Rumbler Solo or Single Compact, no drill, passenger side bracket, Dodge Durango, 2015-2026



RBC2-DUR23ND

Pair of Compact speakers, no drill, (1) passenger side bracket and (1) driver side bracket, Dodge Durango, 2015-2026



RBC1PB-DUR21

(1) Compact, no drill, passenger side bracket. Compatible with DFC Push Bumper Series lower guard, Dodge Durango, 2015-2026



RBC2PB-DUR21

(2) Compact, no drill, (1) passenger side bracket and (1) driver side bracket. Compatible with DFC Push Bumper Series lower guard, Dodge Durango, 2015-2026



RBC1-EXP25ND

(1) Compact, no drill, passenger side bracket, Ford Expedition, 2022-2025



RBC2-EXP25ND

Pair of Compact speakers, no drill, (1) passenger side bracket and (1) driver side bracket, Ford Expedition, 2022-2025



RBS-CHGR15

(1) Rumbler Solo or (1) Compact, no drill, passenger side bracket, Dodge Charger, 2015-2023

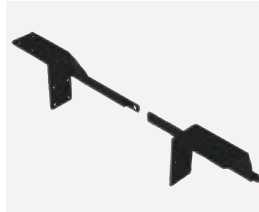

RBC2-FRD15ND

Pair of Compact speakers, no drill, (1) passenger side bracket and (1) driver side bracket, Ford F-150, 2015-2025



RBC1-RAM19ND-C15

(1) Compact, no drill, driver side bracket, RAM Classic 1500, 2019-2024



RBC2-RAM19ND-C15

(2) Compact, no drill, (1) passenger side bracket and (1) driver side bracket, RAM Classic 1500, 2019-2024



RB-UNIV

(2) universal brackets, use for (1) Solo or (1) or (2) Compact



Distributed by Gross Automation | +1 (262) 252-1600 | sales@grossautomation.com

# DynaMax®/ES100C

- Slim and lightweight compact 100 W speaker
- Neodymium driver delivers superior sound quality
- Weather-resistant, composite plastic housing
- Compatible with all Federal Signal electronic siren amplifiers
- Vehicle-specific mounting brackets available



CCR  
TITLE 13

SAE  
J1849

WARRANTY  
2  
YEARS

MODEL	DESCRIPTION
ES100C	Speaker, DynaMax/ES100C, 100 W, high output, compact, Class A
ES100C-DEU	Speaker, DynaMax/ES100C, 100 W, high output, compact, Class A, with Deutsch connector

## DynaMax/ES100C Accessories & Brackets

MODEL	TYPE OF BRACKET	VEHICLE	YEARS
<b>MULTI-VEHICLE</b>			
ESB-U	Bracket only—(1) ES100C		All
ESB-L	Bracket only—(1) ES100C, Multiple orientation "L" bracket		All
ESFMT-EF	Recess mount, stainless steel Electric "F" grille		All
ESBMT-SB	Bumper/surface mount		All
ESFMT-EFB	Flush mount, Black grille		All
<b>FORD</b>			
ESB2-FRDL21ND	No drill, dual speaker bracket only—(2) ES100C, Compatible with models equipped with active air shutters and lower active air dam	F-150	2021-2025
ESB2-FRDL22ND	No drill, dual speaker bracket only - (2) ES100C	F-150 Lightning	2022-2023
ESB-FRDL22ND	No drill, bracket only - (1) ES100C	F-150 Lightning	2022-2023
ESB2-FRD15ND	No drill, dual speaker bracket only—(2) ES100C, EcoBoost models only, not compatible with active lower air dam	F-150/Responder	2015-2025
ESB-U	Multi-vehicle, (1) ES100C	F-250/350/450	2020-2025
ESBL-FPIU20	Combination bracket kit—(1) ES100C and (2) MPS lights behind grille, will not work on hybrid models	Interceptor Utility	2020-2024
ESB-FPIU20NDB	No drill, bracket only—(1) ES100C or (1) AS124, compatible with push bumpers	Interceptor Utility	2020-2024
ESB2-FPIU20NDB	No drill, dual speaker bracket only—(2) ES100C or (2) AS124, compatible with push bumpers	Interceptor Utility	2020-2024
ESBL-FPIU25	Combination bracket kit—(1) ES100C and (2) MPS lights behind grille, will not work on hybrid models	Interceptor Utility	2025
ESB-FPIU25NDB	No drill, bracket only—(1) ES100C or (1) AS124, compatible with push bumpers	Interceptor Utility	2025
ESB2-FPIU25NDB	No drill, dual speaker bracket only—(2) ES100C or (2) AS124, compatible with push bumpers	Interceptor Utility	2025
ESB-MUST24ND	No drill, bracket only - (1) ES100C, EcoBoost and GT models without Performance Package	Mustang	2024-2025
ESBL2-MUST24ND	No drill, combination bracket kit - (2) ES100C and (4) MPS6U or (4) MPS12U lights behind grille, EcoBoost and GT models with Performance Package option	Mustang	2024-2025

Distributed by Gross Automation | +1 (262) 252-1600 | sales@grossautomation.com



DynaMax®/ES100C Accessories & Brackets— Continued

MODEL	TYPE OF BRACKET	VEHICLE	YEARS
<b>DODGE</b>			
ESB-CHGR15	Combination bracket kit—(1) ES100C and (2) MPS lights behind grille, does not mount with Rumbler®	Charger	2015-2023
ESB-CHGR15ND	No drill, (1) ES100C, mounts speaker to hood latch assembly	Charger	2015-2023
ESB2-CHGR15	Single/Dual Speaker bracket—(2) ES100C, does not work with adaptive cruise control option	Charger	2015-2023
ESB-DUR15	Combination bracket kit—(1) ES100C and (2) MPS lights behind grille	Durango SSV/Pursuit	2015-2026
ESBL2-DUR21ND	No drill, combination dual bracket kit—(2) ES100C and (2) MPS lights behind grille	Durango Pursuit	2021-2026
ESBL-RAM16	Combination bracket kit—(1) ES100C and (2) MPS lights behind grille (Not compatible with active air shutters)	Ram SSV & Classic	2016-2025
ESB-U	Multi-vehicle, (1) ES100C	Ram Classic	2019-2025
ESB-SPRNR19-D	Driver side bumper mount, (1) ES100C	Sprinter	2019
ESB-SPRNR19-P	Passenger side bumper mount, (1) ES100C	Sprinter	2019
<b>CHEVROLET</b>			
ESB-SILHD20ND	No drill, bracket only—(1) ES100C on Driver's side	Silverado HD	2019-2021
ESB2-SILHD20ND	No drill, dual, brackets only—(1) ES100C on Driver's side and (1) ES100C on Passenger's side	Silverado HD	2019-2021
ESBL2-SIL22ND	No drill, combination dual bracket kit—(2) ES100C and (2) MPS lights behind grille	Silverado 1500	2022-2025
ESB2-TAH21ND	No drill, dual bracket kit—(2) ES100C behind grille	Tahoe/Surburban	2021-2024
ESBL2-TAH21ND	No drill, combination dual bracket kit—(2) ES100C and (2) MPS lights behind grille	Tahoe	2021-2024
ESB2-TAH25ND	No drill, dual bracket kit - (2) ES100C behind grille	Tahoe	2025
ESBL2-TAH25ND	No drill, combination dual bracket kit - (2) ES100C and (2) MPS lights behind grille	Tahoe	2025
<b>VEHICLE-SPECIFIC KITS</b>			
ES100-ESFMT-EF	Kit, includes (2) ES100C speakers and (2) ESFMT-EF	Kenworth, GM Van, Ford F-650, Ford E-250/450	All

Note

- MPS lights that are compatible with ES100C brackets are MPS6U, MPS12U, MPSWP, and MPSW9



Distributed by Gross Automation | +1 (262) 252-1600 | sales@grossautomation.com

# AS124

- Economical 100 W speaker
- Neodymium driver delivers superior sound quality
- Weather-resistant, composite plastic housing
- Compatible with all Federal Signal electronic siren amplifiers
- Vehicle-specific mounting brackets available



CCR  
TITLE 13

SAE  
J1849



MODEL	DESCRIPTION
750501	Speaker, 100 W, with multi-vehicle mount bolts and hardware, high output, Class A
750501V	Speaker, 100 W, vertical mounting applications, with multi-vehicle mounting bolts and hardware, high output, Class A
<b>ACCESSORIES AND KITS</b>	
750501-07	Mounting bracket for vertical applications, push bumper
750501-08	Mounting bracket, Dodge Durango, 2015-2026, does not mount with Rumbler®
750501-09	Mounting bracket, Dodge Charger, 2015-2023
750501-13	Mounting bracket, Chevrolet Tahoe, 2021-2025
ESB-FPIU20NDB	No drill, bracket only — (1) ES100C or (1) AS124, Police Interceptor Utility, 2020-2024, compatible with push bumpers
ESB-FPIU25NDB	No drill, bracket only — (1) ES100C or (1) AS124, Police Interceptor Utility, 2025-2026, compatible with push bumpers
ESB2-FPIU20NDB	No drill, dual speaker bracket only — (2) ES100C or (2) AS124, Police Interceptor Utility, 2020-2024, compatible with push bumpers
ESB2-FPIU25NDB	No drill, dual speaker bracket only — (2) ES100C or (2) AS124, Police Interceptor Utility, 2025-2026, compatible with push bumpers
<b>COMMON REPLACEMENT PARTS</b>	
Z8280090A	Driver, AS124
Z8556120B	Kit, BP200/AS124, speaker head
Z8650106A	Housing assembly with labels, AS124



750501-07



750501-08



750501-09



750501-13

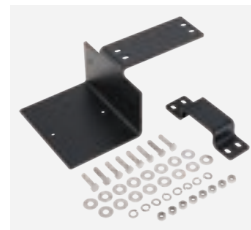

ESB-FPIU20NDB

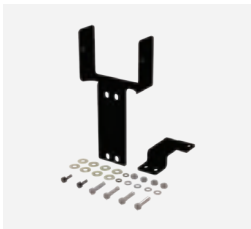

ESB-FPIU25NDB



ESB2-FPIU20NDB



ESB2-FPIU25NDB



Distributed by Gross Automation | +1 (262) 252-1600 | sales@grossautomation.com

Effective January 19, 2026

# TS100-N

- Economical 100 W speaker
- Neodymium driver delivers superior sound quality
- Weather-resistant housing
- Compatible with all Federal Signal electronic siren amplifiers
- Standard mounting bracket included



CCR TITLE 13	SAE J1849	<b>WARRANTY</b> 2 YEARS
-----------------	--------------	-------------------------------

MODEL	DESCRIPTION
TS100-N	Speaker, 100 W, high-output, standard bracket, Class A
<b>COMMON REPLACEMENT PARTS</b>	
Z8470D118	Projector, molded plastic, TS100-N, Black
Z8556082C	Kit, speaker head, TS100-N
Z8556B096A	Cone, 3.25-inch, Black, TS100-N
Z8619145A	Driver, TS100-N

# BP Series

- 200 W speaker
- Neodymium driver delivers superior sound quality
- Designed to be recess-mounted through the bumper of a vehicle
- Available with the stainless steel Electric F grille or the traditional Chrome Q-Siren® grille



BP200-EF

CCR TITLE 13	SAE J1849	<b>WARRANTY</b> 2 YEARS
-----------------	--------------	-------------------------------

MODEL	DESCRIPTION
BP200-EF	200 W, Stainless steel Electric "F" grille, recess mount
BP200-Q	200 W, Chrome Q-Siren grille, recess mount
<b>Accessory</b>	
BPFMT-EF	Recess mount, stainless steel Electric "F" grille
<b>COMMON REPLACEMENT PARTS</b>	
Z8280090A	Driver, 100 W, neomagnet
Z8280104B	Front grille, Q2B siren/BP200-Q, Chrome-plated Q-Siren emblem
Z8556120B	Kit, BP200/AS124, speaker head
Z8567102A	Grille, MSFMT-EF/BP200-EF, stainless steel Electric "F"
Z1751082A	Wire harness, BP200



Distributed by Gross Automation | +1 (262) 252-1600 | sales@grossautomation.com

# FireRay® LED 4x3

- Surface mount, warning light available in four sizes
- Dual-color models
- (13) flash patterns and up to (4) flashing modes
- 12 Vdc
- Black or Chrome bezel optional

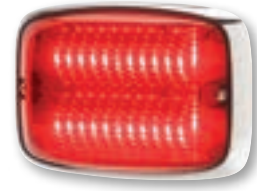

FR4C2-RW  
(shown with optional Chrome bezel FR4MC)

	<b>DUAL-COLOR LED OPTIONS</b> 					

MODEL	DESCRIPTION
FR4C2-AG	Dual-color, Amber/Green LEDs, Clear lens
FR4C2-AW	Dual-color, Amber/White LEDs, Clear lens
FR4C2-BA	Dual-color, Blue/Amber LEDs, Clear lens
FR4C2-BW	Dual-color, Blue/White LEDs, Clear lens
FR4C2-RB	Dual-color, Red/Blue LEDs, Clear lens
FR4C2-RW	Dual-color, Red/White LEDs, Clear lens
<b>ACCESSORIES</b>	
FR4MB	4x3 trim bezel, Black
FR4MC	4x3 trim bezel, Chrome

Distributed by Gross Automation | +1 (262) 252-1600 | sales@grossautomation.com



Effective January 19, 2026

# FireRay® LED 6x4

- Surface mount, warning light available in four sizes
- Single- and dual-color models
- (13) flash patterns and up to (4) flashing modes
- 12 Vdc
- Black or Chrome bezel optional

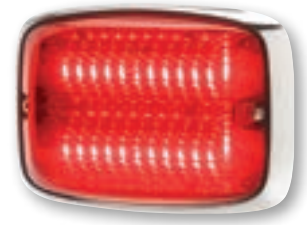

FR6R1-R  
(shown with optional Chrome bezel FR6MC)



**SINGLE- AND DUAL-COLOR LED OPTIONS**



MODEL	DESCRIPTION
FR6A1-A	Single-color, Amber LEDs, Amber lens
FR6B1-B	Single-color, Blue LEDs, Blue lens
FR6C1-A	Single-color, Amber LEDs, Clear lens
FR6C1-B	Single-color, Blue LEDs, Clear lens
FR6C1-R	Single-color, Red LEDs, Clear lens
FR6C1-W	Single-color, White LEDs, Clear lens
FR6R1-R	Single-color, Red LEDs, Red lens
FR6C2-AG	Dual-color, Amber/Green LEDs, Clear lens
FR6C2-AW	Dual-color, Amber/White LEDs, Clear lens
FR6C2-BA	Dual-color, Blue/Amber LEDs, Clear lens
FR6C2-BW	Dual-color, Blue/White LEDs, Clear lens
FR6C2-RA	Dual-color, Red/Amber LEDs, Clear lens
FR6C2-RB	Dual-color, Red/Blue LEDs, Clear lens
FR6C2-RW	Dual-color, Red/White LEDs, Clear lens
<b>Scene light</b>	
FR6LEDCENE	Scene light, Clear lens
<b>Brake/Tail/Turn and Backup lights</b>	
FR6-ARROW	Arrow, Amber LEDs, Amber lens
FR6-BACKUP	Backup light, White LEDs, Clear lens
FR6-BTT	Brake/Tail/Turn, Red LEDs, Red lens
<b>ACCESSORIES AND KITS</b>	
FR6MB	Trim bezel, Black
FR6MB4V	4-position vertical casting, Black
FR6MC	Trim bezel, Chrome
FR6MC3V	3-position vertical casting, Chrome
FR6MC4V	4-position vertical casting, Chrome
FR6MHL	Headlight Mount Kit
FR6-A4HMC	Mounting kit to convert FireRay 6x4 to fit in QuadraFlare® 6x4 mounting holes
FR6-SPACRKT	Kit of two 7-degree rubber mounting wedges for use with FR6 lights



FireRay LED 6x4 (FR6C1-R) mounted on bumper with two-to-four hole conversion kit (FR6-A4HMC)



FireRay LED three-position vertical casting (FR6MC3V) with brake/tail/turn (FR6-BTT), arrow (FR6-ARROW), and backup (FR6-BACKUP)



Distributed by Gross Automation | +1 (262) 252-1600 | sales@grossautomation.com

# FireRay® LED 7x3

- Surface mount, warning light available in four sizes
- Single- and dual-color models
- (13) flash patterns and up to (4) flashing modes
- 12 Vdc
- Black or Chrome bezel optional



FR7R1-R  
(shown with optional  
Chrome bezel FR7MC)



**SINGLE- AND DUAL-COLOR LED OPTIONS**



MODEL	DESCRIPTION
FR7A1-A	Single-color, Amber LEDs, Amber lens
FR7C1-A	Single-color, Amber LEDs, Clear lens
FR7C1-B	Single-color, Blue LEDs, Clear lens
FR7C1-R	Single-color, Red LEDs, Clear lens
FR7C1-W	Single-color, White LEDs, Clear lens
FR7R1-R	Single-color, Red LEDs, Red lens
FR7C2-AW	Dual-color, Amber/White LEDs, Clear lens
FR7C2-BA	Dual-color, Blue/Amber LEDs, Clear lens
FR7C2-BW	Dual-color, Blue/White LEDs, Clear lens
FR7C2-RB	Dual-color, Red/Blue LEDs, Clear lens
FR7C2-RW	Dual-color, Red/White LEDs, Clear lens
<b>Scene light</b>	
FR7LEDSCENE	Scene light, Clear lens
<b>ACCESSORIES AND KITS</b>	
FR7MB	Trim bezel, Black
FR7MC	Trim bezel, Chrome
FR7-A4HMC	Mounting kit to convert FireRay 7x3 to fit in QuadraFlare® 7x3 mounting holes

Distributed by Gross Automation | +1 (262) 252-1600 | sales@grossautomation.com



Effective January 19, 2026

# FireRay® LED 9x7

- Surface mount, warning light available in four sizes
- Single- and dual-color models
- (13) flash patterns and up to (4) flashing modes
- 12 Vdc
- Black or Chrome bezel optional



FR9R1-R  
(shown with optional Chrome bezel FR9MC)



**SINGLE- AND DUAL-COLOR LED OPTIONS**



CCR  
TITLE 13

NFPA  
1900

GSA KKK-  
A-182ZF

IP67



MODEL	DESCRIPTION
FR9A1-A	Single-color, Amber LEDs, Amber lens
FR9B1-B	Single-color, Blue LEDs, Blue lens
FR9C1-A	Single-color, Amber LEDs, Clear lens
FR9C1-B	Single-color, Blue LEDs, Clear lens
FR9C1-R	Single-color, Red LEDs, Clear lens
FR9C1-W	Single-color, White LEDs, Clear lens
FR9R1-R	Single-color, Red LEDs, Red lens
FR9C2-AW	Dual-color, Amber/White LEDs, Clear lens
FR9C2-BW	Dual-color, Blue/White LEDs, Clear lens
FR9C2-RB	Dual-color, Red/Blue LEDs, Clear lens
FR9C2-RW	Dual-color, Red/White LEDs, Clear lens
<b>Scene light</b>	
FR9LEDSCENE	Scene light, Clear lens
<b>ACCESSORIES AND KITS</b>	
FR9MB	Trim bezel, Black
FR9MC	Trim bezel, Chrome
FR9MBSCENE	Trim bezel, Scene light, Black
FR9MCSCENE	Trim bezel, Scene light, Chrome
FR9-A4HMC	Mounting kit to convert FireRay 9x7 to fit in QuadraFlare® 9x7 mounting holes



FireRay LED 9x7 (FR9C1-R) mounted on side and rear of fire engine



Distributed by Gross Automation | +1 (262) 252-1600 | sales@grossautomation.com

# QuadraFlare® 4x3

- Exterior warning light
- Single- and split-color models
- (26) flash patterns and (4) flashing modes
- 12 Vdc
- Black or Chrome bezel optional



QL43C-RW  
(shown with optional Chrome bezel QL43MC)



**SINGLE- AND SPLIT-COLOR LED OPTIONS**



MODEL	DESCRIPTION
QL43-AA	4x3 Warning lights, Amber LEDs, Amber lens
QL43-BB	4x3 Warning lights, Blue LEDs, Blue lens
QL43-RR	4x3 Warning lights, Red LEDs, Red lens
QL43C-AA	4x3 Warning lights, Amber LEDs, Clear lens
QL43C-BB	4x3 Warning lights, Blue LEDs, Clear lens
QL43C-RR	4x3 Warning lights, Red LEDs, Clear lens
QL43C-WW	4x3 Warning lights, White LEDs, Clear lens
QL43C-BA	4x3 Split color Warning lights, Blue/Amber LEDs split, Clear lens
QL43C-RB	4x3 Split color Warning lights, Red/Blue LEDs split, Clear lens
QL43C-RW	4x3 Split color Warning lights, Red/White LEDs split, Clear lens
QL43-BACKUP	Backup light, White LEDs, Clear lens
QL43-BTT	Brake/Tail/Turn, Red LEDs, Red lens
QL43-TURN	Turn light, Amber LEDs, Amber lens
<b>ACCESSORY</b>	
QL43MC	Trim bezel, Chrome with gasket

Distributed by Gross Automation | +1 (262) 252-1600 | sales@grossautomation.com



Effective January 19, 2026

# QuadraFlare® 6x4

- Exterior warning light
- Single- and split-color models
- (26) flash patterns and (4) flashing modes
- 12 Vdc
- Black or Chrome bezel optional



QL64C-RR  
(shown with optional Chrome bezel QL64MC)



**SINGLE- AND SPLIT-COLOR LED OPTIONS**



MODEL	DESCRIPTION
	<b>6x4 Warning lights with Color lens and built-in flasher</b>
QL64-AA	Amber LEDs, Amber lens
QL64-BB	Blue LEDs, Blue lens
QL64-GG	Green LEDs, Green lens
QL64-RR	Red LEDs, Red lens
QL64-RRDEU	Red LEDs, Red lens, with Deutsch connector
	<b>6x4 Warning lights with Clear lens and built-in flasher</b>
QL64C-AA	Amber LEDs, Clear lens
QL64C-BB	Blue LEDs, Clear lens
QL64C-GG	Green LEDs, Clear lens
QL64C-RR	Red LEDs, Clear lens
QL64C-WW	White LEDs, Clear lens
	<b>6x4 Split color Warning lights with Clear lens and built-in flasher</b>
QL64C-AG	Amber/Green LEDs split, Clear lens
QL64C-RA	Red/Amber LEDs, Split, Clear lens
QL64C-RB	Red/Blue LEDs split, Clear lens
QL64C-RG	Red/Green LEDs split, Clear lens
QL64C-RW	Red/White LEDs split, Clear lens
	<b>6x4 Scene Light</b>
QL64LEDSCENE-SB	White LEDs, surface mount

MODEL	DESCRIPTION
	<b>6x4 Brake/Tail/Turn and Backup lights</b>
QL64-BTT	Brake/Tail/Turn, Red LEDs, Red lens
QL64-ARROW	Turn arrow, Amber LEDs, Amber lens
QL64-TURN	Turn light, Amber LEDs, Amber lens
QL64-BACKUP	Backup light, White LEDs, Clear lens
	<b>6x4 3-Position Vertical Casting</b>
QL643V-LEFT	Installed QL64-BTT, QL64-ARROW (left facing), QL64-BACKUP
QL643V-RIGHT	Installed QL64-BTT, QL64-ARROW (right facing), QL64-BACKUP
QL643V-LED	Installed QL64-BTT, QL64-TURN, QL64-BACKUP
QL643V	Casting with gasket
	<b>6x4 3-Position Horizontal Casting</b>
QL643H-LEFT	Installed QL64-BTT, QL64-ARROW (left facing), QL64-BACKUP
QL643H-RIGHT	Installed QL64-BTT, QL64-ARROW (right facing), QL64-BACKUP
QL643H-LEDLEFT	Installed QL64-BTT, QL64-TURN, QL64-BACKUP
QL643H-LEDRGHT	Installed QL64-BTT, QL64-TURN, QL64-BACKUP
QL643H	Casting with gasket
	<b>6x4 4-Position Vertical Casting</b>
QL644V-LEFT	Installed QL64-BTT, QL64-ARROW (left facing), QL64-BACKUP, QL64-RR
QL644V-RIGHT	Installed QL64-BTT, QL64-ARROW (right facing), QL64-BACKUP, QL64-RR
QL644V-LED	Installed QL64-BTT, QL64-TURN, QL64-BACKUP, QL64-RR
QL644V	Casting with gasket
	<b>ACCESSORIES AND KITS</b>
QL64MBLK	Trim bezel, Black with gasket
QL64MC	Trim bezel, Chrome with gasket
QL64MHL	Headlight mount kit



Distributed by Gross Automation | +1 (262) 252-1600 | sales@grossautomation.com



Effective January 19, 2026

# QuadraFlare® 9x7

- Exterior warning light
- Single- and split-color models
- (26) flash patterns and (4) flashing modes
- 12 Vdc
- Black or Chrome bezel optional



QL97C-RW  
(shown with optional Chrome bezel QL97MC)

**SINGLE-, DUAL-, AND SPLIT-COLOR LED OPTIONS**





MODEL	DESCRIPTION
QL97-AA	9x7 Warning lights, Amber LEDs, Amber lens
QL97-BB	9x7 Warning lights, Blue LEDs, Blue lens
QL97-RR	9x7 Warning lights, Red LEDs, Red lens
QL97C-AA	9x7 Warning lights, Amber LEDs, Clear lens
QL97C-BB	9x7 Warning lights, Blue LEDs, Clear lens
QL97C-RR	9x7 Warning lights, Red LEDs, Clear lens
QL97C-WW	9x7 Warning lights, White LEDs, Clear lens
QL97C-RA	9x7 Split color Warning lights, Red/Amber LEDs split, Clear lens
QL97C-RB	9x7 Split color Warning lights, Red/Blue LEDs split, Clear lens
QL97C-RW	9x7 Split color Warning lights, Red/White LEDs split, Clear lens
QL97LEDSCENE-SB	9x7 Scene light, White LEDs, Clear lens, surface mount
QL97LEDSCENE-SB-D	9x7 Scene light, White LEDs, Clear lens, surface mount, Duetsch connector
<b>ACCESSORIES AND KITS</b>	
QL97MBLK	Trim bezel, Black with gasket
QL97MC	Trim bezel, Chrome with gasket

Distributed by Gross Automation | +1 (262) 252-1600 | sales@grossautomation.com







Effective January 19, 2026

# MicroPulse® Ultra D-Pillar

- D-Pillar warning light system
- System includes vacuum-formed vehicle-specific shrouds, MicroPulse Ultra (6) light heads, (2) shroud/bracket assemblies, (2) harnesses, and (1) 24-channel expansion module
- Tri-color models
- Full customization of flash patterns and auxiliary signals such as brake, reverse, and turn signals
- Multi-voltage, 12/24 Vdc





**TRI-COLOR LED OPTIONS**









MODEL	DESCRIPTION
ELSD-FPIU20RBA	Lighting system, D-Pillar, 2020-2025 Ford Police Interceptor Utility, Red/Blue/Amber
ELSD-FPIU20RBW	Lighting system, D-Pillar, 2020-2025 Ford Police Interceptor Utility, Red/Blue/White
ELSD-TAH21RBA	Lighting system, D-Pillar, 2021-2025 Chevrolet Tahoe/Suburban, Red/Blue/Amber
ELSD-TAH21RBW	Lighting system, D-Pillar, 2021-2025 Chevrolet Tahoe/Suburban, Red/Blue/White
ELSD-DUR21RBA	Lighting system, D-Pillar, 2021-2025 Dodge Durango, Red/Blue/Amber
ELSD-DUR21RBW	Lighting system, D-Pillar, 2021-2025 Dodge Durango, Red/Blue/White
ELSD-FRD21RBA	Lighting system, D-Pillar, 2021-2025 Ford F-150, Red/Blue/Amber
ELSD-FRD21RBW	Lighting system, D-Pillar, 2021-2025 Ford F-150, Red/Blue/White

# MicroPulse® C Series

- Low-profile perimeter warning light
- Single- and dual-color models
- (27) single-color or (18) dual-color flash patterns
- 12 Vdc
- Black surface mount bezel and stud mount standard



**SINGLE- AND DUAL-COLOR LED OPTIONS**





MODEL	DESCRIPTION
MPSC-A	Single-color, (6) Amber LEDs, Clear lens
MPSC-B	Single-color, (6) Blue LEDs, Clear lens
MPSC-R	Single-color, (6) Red LEDs, Clear lens
MPSC-W	Single-color, (6) White LEDs, Clear lens
MPSC2-AW	Dual-color, (8), Amber/White LEDs, Clear lens
MPSC2-BW	Dual-color, (8) Blue/White LEDs, Clear lens
MPSC2-RB	Dual-color, (8) Red/Blue LEDs, Clear lens
MPSC2-RW	Dual-color, (8) Red/White LEDs, Clear lens

Distributed by Gross Automation | +1 (262) 252-1600 | sales@grossautomation.com

# MicroPulse® Wide Angle Pro



MPSWP-RAW

- 180-degree wide angle perimeter light
- Single- and tri-color models
- Integrated waterproof connector on all models
- Downward projected White light
- (25) flash patterns
- Multi-voltage, 12/24 Vdc
- Wide range of external mounting applications
- Black bezel standard; Chrome or White bezel optional





**TRI-COLOR LED OPTIONS**





MODEL	DESCRIPTION
<b>Tri-Color, Clear lens</b>	
MPSWP-AGW	Tri-color, (18) Amber/Green/White LEDs, (2) Downward projected White LEDs, Clear lens
MPSWP-BAW	Tri-color, (18) Blue/Amber/White LEDs; (2) Downward projected White LEDs, Clear lens
MPSWP-RAW	Tri-color, (18) Red/Amber/White LEDs; (2) Downward projected White LEDs, Clear lens
MPSWP-RBA	Tri-color, (18) Red/Blue/Amber LEDs; (2) Downward projected White LEDs, Clear lens
MPSWP-RBW	Tri-color, (18) Red/Blue/White LEDs; (2) Downward projected White LEDs, Clear lens
MPSWP-RGW	Tri-color, (18) Red/Green/White LEDs; (2) Downward projected White LEDs, Clear lens
<b>ACCESSORIES</b>	
MPSUMB6-1	Chrome bezel for (1) MicroPulse Wide Angle Pro
MPSUMB6-2	White bezel for (1) MicroPulse Wide Angle Pro
WPCABLE-8	Extension cable for (1) MicroPulse with waterproof connector, 8-ft
WPCABLE-15	Extension cable for (1) MicroPulse with waterproof connector, 15-ft
WPCABLE-30	Extension cable for (1) MicroPulse with waterproof connector, 30-ft
WPCABLE2-25	Harness for (2) MicroPulse with waterproof connector, 25-ft
WPCABLE4-25	Harness for (4) MicroPulse with waterproof connector, 25-ft
Z17502542A	Harness for (3) MicroPulse with waterproof connector, 12-ft
WPCONKIT-20	Mating connectors, bulk pack, 20
WPCONKIT-200	Mating connectors, bulk pack, 200
<b>COMMON REPLACEMENT PART</b>	
MPSUMB6-3	Black bezel

Distributed by Gross Automation | +1 (262) 252-1600 | sales@grossautomation.com



Effective January 19, 2026

# MicroPulse® Wide Angle 9

- 180-degree wide angle perimeter light
- Single- and tri-color models
- (12) single-color or (20) tri-color flash patterns
- Multi-voltage, 12/24 Vdc
- Wide range of external mounting applications
- Black bezel standard; Chrome or White bezel optional



MPSW9-R



**SINGLE- AND TRI-COLOR LED OPTIONS**



CCR  
TITLE 13

IP67

NFPA  
1900



MODEL	DESCRIPTION
MPSW9-A	Single-color, (9) Amber LEDs, Clear lens
MPSW9-B	Single-color, (9) Blue LEDs, Clear lens
MPSW9-R	Single-color, (9) Red LEDs, Clear lens
MPSW9-W	Single-color, (9) White LEDs, Clear lens
MPSW9-AGW	Tri-color, (18) Amber/Green/White LEDs, Clear lens
MPSW9-BAW	Tri-color, (18) Blue/Amber/White LEDs, Clear lens
MPSW9-RAW	Tri-color, (18) Red/Amber/White LEDs, Clear lens
MPSW9-RBA	Tri-color, (18) Red/Blue/Amber LEDs, Clear lens
MPSW9-RBW	Tri-color, (18) Red/Blue/White LEDs, Clear lens
<b>ACCESSORIES</b>	
MPSMW9-1	Chrome bezel for (1) MPSW9
MPSMW9-2	White bezel for (1) MPSW9
<b>COMMON REPLACEMENT PART</b>	
MPSMW9-3	Black bezel for (1) MPSW9

Distributed by Gross Automation | +1 (262) 252-1600 | sales@grossautomation.com



## UNIVERSAL MOUNT

<b>MPSM3-DL</b> Generic L-Bracket for (2) MPS3U lights, side-by-side	<b>MPSM6-DL</b> Generic L-bracket for (2) MPS6U lights, side-by-side	<b>MPSM12-DL</b> Generic L-bracket for (2) MPS12U lights, side-by-side	<b>MPSM3-DS</b> Generic L-Bracket for (2) MPS3U lights, stacked	<b>MPSM6-DS</b> Generic L-bracket for (2) MPS6U lights, stacked
<b>MPSM12-DS</b> Generic L-bracket for (2) MPS12U lights, stacked	<b>MPSM3-LB</b> Generic L-Bracket for (1) MPS3U light	<b>MPSM6-LB</b> Generic L-bracket for (1) MPS6U light	<b>MPSM12-LB</b> Generic L-bracket for (1) MPS12U light	<b>MPSM3-SB</b> Swivel Mount Bracket for (1) MPS3U light
<b>MPSM6-SB</b> Swivel mount bracket for (1) MPS6U light	<b>MPSM12-SB</b> Swivel mount bracket for (1) MPS12U light	<b>MPSMC-LBWN</b> L-bracket kit for (1) MPSC light	<b>MPSMC-SBWN</b> Swivel mount bracket for (1) MPSC light	<b>MPSMW9-LB</b> L-Bracket for (1) MPSW9

## PYLON MOUNT

<b>MPSM3U-PLN</b> Pylon mount for (1) MPS3U light	<b>MPSM6U-PLN</b> Pylon mount for (1) MPS6U light	<b>MPSM12U-PLN</b> Pylon mount for (1) MPS12U light

## WEDGE KIT

<b>MPSM3UC-SPACRKT</b> Kit of four 5-degree rubber mounting wedges for use with MPS3U lights	<b>MPSM6U-SPACRKT</b> Kit of four 5-degree rubber mounting wedges for use with MPS6U lights			
<b>MPSM12U-SPACRKT</b> Kit of four 5-degree rubber mounting wedges for use with MPS12U lights	<b>MPSM6U-FPIU20SMW</b> Kit of two 20-degree rubber mounting wedges, each wedge mounts (1) MPS6U light to each side mirror arm, Ford Police Interceptor Utility, 2020-2025	<b>MPSM6U-FPIU20WW</b> Kit of four rubber mounting wedges, each wedge mounts (1) MPS6U light to each of the four wheel arch moldings, Ford Police Interceptor Utility, 2020-2025	<b>MPSMW9-SPACRKT</b> Kit for (4) 5-degree rubber mounting wedges for use with MPSW9 lights	<b>MPSMW9-SPACRKT2</b> Pair of 22-degree rubber mounting wedges for MPSW9, Ford F-150 2023-2025, and RAM 2500, 2023-2025

Distributed by Gross Automation | +1 (262) 252-1600 | sales@grossautomation.com



**GROMMET MOUNT**



MPSM3U-RND2

4-inch round mounting plate kit for (2) MPS3U, with rubber grommet



330510\*

6-inch oval mounting plate kit for (1) MPS12U, with rubber grommet (light sold separately)



MPSM6U-HOOD

Drill-less hood mount bracket for (1) MPS6U light



MPSM3U-RAM24DTL

Pair of drill-less taillight brackets for horizontal orientation, each bracket holds (1) MPS3U light, RAM, 2024+



MPSM3U-RAM24DTL2

Pair of drill-less taillight brackets for horizontal orientation, each bracket holds (2) MPS3U light, RAM, 2024+



MPSM3U-FRD24DTL

Pair of drill-less taillight brackets for vertical orientation, each bracket holds (1) MPS3U light, Ford F-250/350/450, 2023+



MPSM3U-FRD24DTL2

Pair of drill-less taillight brackets for vertical orientation, each bracket holds (2) MPS3U lights, Ford F-250/350/450, 2023-2025



MPSM12U-FRD25DTL

Pair of drill-less taillight brackets for vertical orientation, each bracket holds (1) MPS6U/MPS12U light, Ford F-150, 2023-2025; will not fit Lightning



MPSM12U-FRD25DTL2

Pair of drill-less taillight brackets for vertical orientation, each bracket holds (1) MPS6U/MPS12U light and (1) MPS3U/MPS6U light, Ford F-150, 2023-2025; will not fit Lightning



MPSM6U-WIN

Adhesive mount for (1) MPS6U light. Kit includes 90°, 67°, 46°, and 30° shrouds



MPSM6U-WIN2

Dual adhesive mount for (2) MPS6U lights. Kit includes 90°, 67°, 46°, and 30° shrouds



MPSM6U-WIN46-12

Adhesive mount for (12) MPS6U lights. Kit includes 46° shrouds

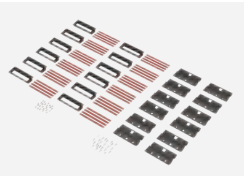

MPSM6U-WIN90-12

Adhesive mount for (12) MPS6U lights. Kit includes 90° shrouds



MPSM12U-WIN

Adhesive mount for (1) MPS12U light. Kit includes 90°, 67°, 46°, and 30° shrouds

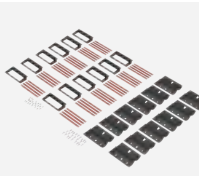

MPSM12U-WIN90-12

Adhesive mount for (12) MPS12U lights. Kit includes 90° shrouds

**SPOILER MOUNT**

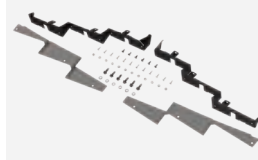

MPSM6-TA21RS

Pair of spoiler brackets, each bracket holds (3) MPS6U lights, Chevrolet Tahoe, 2021-2025

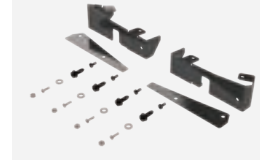

MPSM6-TA21RS1

2-head MPS6U spoiler bracket kit, Chevrolet Tahoe/Suburban, 2021-2025



MPSM6-FPIU20RS1

Pair of spoiler brackets, each bracket holds (1) MPS6U light, Ford Police Interceptor Utility, 2020-2025



MPSM6-FPIU20RS2

Pair of spoiler brackets, each bracket holds (3) MPS6U lights, Ford Police Interceptor Utility, 2020-2025



MPSM6-FPIU20RS3

Pair of spoiler brackets, each bracket holds (2) MPS6U lights, Ford Police Interceptor Utility, 2020-2025

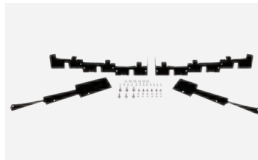

MPSM12-FPIU20RS2

Pair of spoiler brackets, each bracket holds (3) MPS12U lights, Ford Police Interceptor Utility, 2020-2025



MPSM12-DU22RS

Pair of spoiler brackets, each bracket holds (3) MPS12U lights, Dodge Durango, 2022-2026



MPSM6-DU22RS

6-head MPS6U spoiler bracket kit, Dodge Durango, 2015-2026

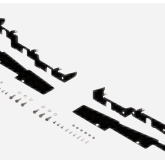

MPSM6U-EXP22RS6

Rear spoiler bracket kit, (3) MPS6U lights on each side of spoiler, Ford Expedition, 2022-2024

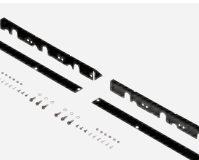

MPS6U-SIL19RS6

Rear spoiler bracket kit, (3) MPS6U lights on each side of spoiler, Chevrolet Silverado 2019-2025



Distributed by Gross Automation | +1 (262) 252-1600 | sales@grossautomation.com

## SIDE MIRROR

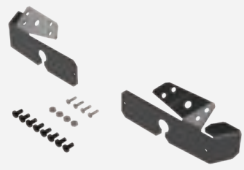

MPSMW9-TAH21MIR

Pair of side mirror brackets, each bracket holds (1) MPSW9 or MPSWP light, Chevrolet Tahoe, 2021-2025



MPSMW9-SIL19MIR

Pair of side mirror brackets, each bracket holds (1) MPSW9 or MPSWP light, Chevrolet Silverado 1500, 2019-2025



MPSMW9-FPIU20MIR

Pair of side mirror brackets, each bracket holds (1) MPSW9 or MPSWP light, Ford Police Interceptor Utility, 2020-2024

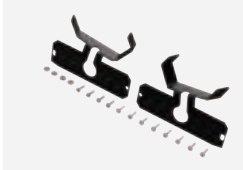

MPSMW9-FPIU25MIRS

Pair of side mirror brackets, each bracket holds (1) MPSW9 or MPSWP light, Ford Police Interceptor Utility, 2025



MPSMW9-FRD21MIR

Pair of side mirror brackets, each bracket holds (1) MPSW9 or MPSWP light, Ford F-150 (non-towing mirrors)/Lightning, 2021-2025

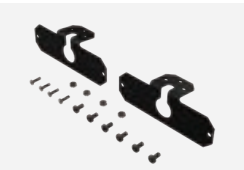

MPSMW9S-UNIVMIR

Pair of side mirror brackets, each bracket holds (1) MPSW9 or MPSWP light, RAM 1500 (5TH GEN) 2023-2024, RAM 1500 Classic (4TH GEN) 2023-2024, Ford F-250/F-350 (towing mirrors) 2023-2025



MPSMW9-DUR21MIRS

Pair of side mirror brackets, each bracket holds (1) MPSW9 or MPSWP light, Dodge Durango, 2015-2026



MPSMW9-SHD

Shroud for (1) MPSW9 or MPSWP light, multi-vehicle applications



MPSMW9-CHGR11MIR

Pair of side mirror brackets, each bracket holds (1) MPSW9 or MPSWP light, Dodge Charger, 2011-2023



MPSMW9-EXP19MIR

Pair of side mirror brackets, each bracket holds (1) MPSW9 or MPSWP light, Ford Expedition, 2019-2024

## D-PILLAR



MPSM6U-BP1

Pair of B-pillar brackets, each bracket mounts (1) MPS6U light on the rear of B-pillar, Dodge Charger, 2011-2023



MPSM6U-BP2

Pair of B-pillar brackets, each bracket mounts (1) MPS6U light on the rear of B-pillar, Chevrolet Tahoe, 2021-2025 and Ford Police Interceptor Utility, 2020-2025

## FOG LIGHT

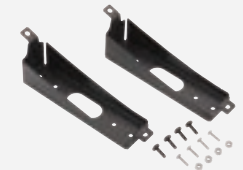

MPS6U-FPIU20FOG

Pair of fog light brackets, each bracket holds (1) MPS3U/MPS6U light, Ford Police Interceptor Utility, 2020-2025

## SURFACE MOUNT ANGLED BEZEL



MPSUMA12-1

40° angled bezel for (1) MPS12U light, Chrome



MPSUMA12-3

40° angled bezel for (1) MPS12U light, Black

## RUNNING BOARD MOUNT

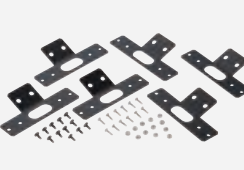

MPSM6-FRD15RB

(6) Running board brackets, each bracket holds (1) MPS6U light, Ford F-150 Responder, 2015-2025 (Includes XL and XLT trim levels with OEM running boards)

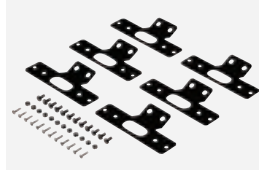

MPSM6U-FD15UPRB

(6) Upper running board brackets, each bracket holds (1) MPS6U light, Ford F-150 Responder, 2015-2025

Distributed by Gross Automation | +1 (262) 252-1600 | sales@grossautomation.com

**LICENSE PLATE**



**IPX-LPV1**  
Flat surface license plate bracket, mounts MPS3U lights, various vehicles without recessed plate mounting locations

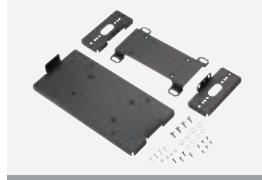

**IPX-LPV2**  
Adjustable license plate bracket, mounts MPS3U/MPS6U/MPS12U lights to the license plate of popular vehicles



**IPX-LPVX1**  
Extended license plate bracket, mounts MPS3U lights, for vehicles with a recessed license plate mount location

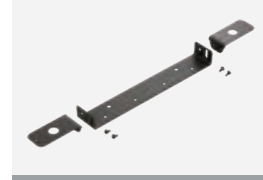

**IPX-LPH1**  
Generic high side license plate holder with horizontal mount tab on each side, mounts MPS3U lights, fits most vehicles

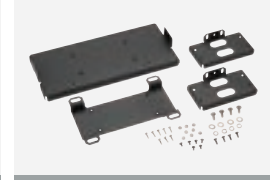

**MPSM6-LPV1**  
Vertical mount license plate brackets, each bracket holds (2) MPS6U light heads on each side

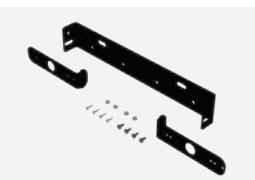

**MPSM-LPH1**  
Horizontal license plate bracket, mounts (2) MPS3U/MPS6U/MPSC lights, fits most vehicles



**MPSM6-LPH1**  
Horizontal license plate mount, (2) MPS6U, MPS12U, MPSW9 lights



**MPSM6-LPV3-DUR**  
Vertical License plate mount each bracket holds (1) MPS6U on each side, fits most vehicles, will not interfere with 2023-2026 Dodge Durango Keyhole

**GRILLE**



**IPX-GRL8**  
Pair of grille brackets with hardware, horizontal mount orientation, each bracket holds (1) MPS3U/MPS6U/MPS12U light, Dodge Charger, 2015-2023, without Rumbler® installation

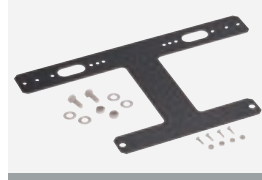

**IPX-GRL16**  
Single grille bracket with hardware, no drill, horizontal mount orientation, bracket holds (2) MPS3U/MPS6U/MPS12U lights, Ford Police Interceptor Utility, 2020-2025



**IPX-GRL17**  
Pair of lower grille brackets with hardware, horizontal mount orientation, each bracket holds (2) MPS3U/MPS6U lights, Ford Police Interceptor Utility, 2020-2025

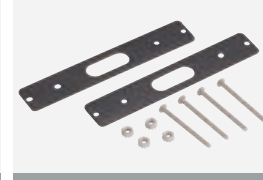

**MPSM6-GRL1**  
Pair of grille brackets, each bracket holds (1) MPS3U/MPS6U light, fits vehicles with a mesh grille

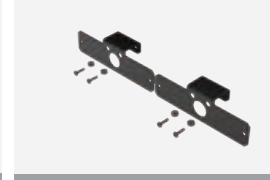

**MPSM6U-FPIU20GCO**  
Kit of two grille cut-out brackets, adapts (2) MPS6U lights to OEM grille cut outs, Ford Police Interceptor Utility, 2020-2025



**MPSM6-GRL2**  
Pair of grille brackets, each bracket holds (1) MPS6U light behind grille, Chevrolet Tahoe, 2021-2025

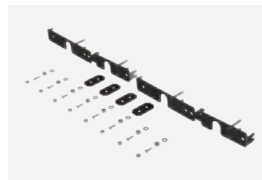

**MPSM6-GRL3**  
Pair of grille brackets, each bracket holds (2) MPS6U light outside of grille, each side of bowtie, Chevrolet Tahoe, 2021-2024

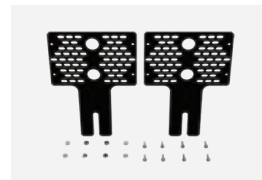

**MPSM-GRL4**  
Pair of grille brackets, each bracket holds (2) MPS6U or (2) MPS12U lights, Ford Mustang, 2025

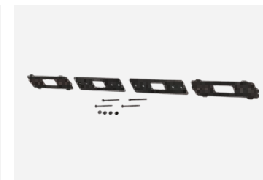

**MPSM6-GRL5**  
Pair of grille brackets with hardware, each bracket holds (1) MPS3U/MPS6U/MPS12U

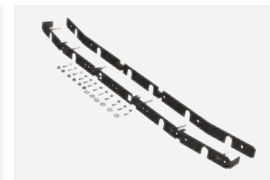

**MPSM6U-EXPD25-6GRL**  
Single grille bracket with hardware, bracket holds (6) MPS6U lights, Ford Expedition, 2025



Distributed by Gross Automation | +1 (262) 252-1600 | sales@grossautomation.com

# DynaFlare™

- Low-profile, perimeter light
- Single-, dual, and tri-color capability
- Amber, Blue, Green, Red, and White
- Lights can be programmed to flash, steady override, dim, and cruise
- Fully sealed with optically clear potting material
- Suitable for exterior and interior mounting locations
- Multi-voltage, 12/24 Vdc













MODEL	DESCRIPTION
-------	-------------

**6-foot Models**

DR6-RBW	(1) Red/Blue/White LEDs, Clear lens
DR6-BAW	(1) Blue/Amber/White LEDs, Clear lens
DR6-RAW	(1) Red/Amber/White LEDs, Clear lens
DR6-RBA	(1) Red/Blue/Amber LEDs, Clear lens
DR6-AGW	(1) Amber/Green/White LEDs, Clear lens
DR6-RGW	(1) Red/Green/White LEDs, Clear lens
DR6-RBW-SMK	(1) Red/Blue/White LEDs, Smoked lens

**5-foot Models**

DR5-RBW	(1) Red/Blue/White LEDs, Clear lens
DR5-BAW	(1) Blue/Amber/White LEDs, Clear lens
DR5-RAW	(1) Red/Amber/White LEDs, Clear lens
DR5-RBA	(1) Red/Blue/Amber LEDs, Clear lens
DR5-AGW	(1) Amber/Green/White LEDs, Clear lens
DR5-RGW	(1) Red/Green/White LEDs, Clear lens
DR5-RBW-SMK	(1) Red/Blue/White LEDs, Smoked lens

**ACCESSORIES**

DR5BKT-RB-DUR15	(1) 5-foot running board mounting bracket, 2015-2026 Dodge Durango
DR6BKT-RB-EXPD25	(1) 6-foot running board mounting bracket, 2025 Ford Expedition
DRBKT-RB-FPIU20B	(1) Running board mounting bracket, 2020-2025 Ford Police Interceptor Utility
DR6BKT-RB-FRD15B	(1) 6-foot running board mounting bracket, 2015-2025 Ford F-150
DR6BKT-RB-SIL19B	(1) 6-foot running board mounting bracket, 2019-2025 Chevrolet Silverado
DR6BKT-RB-TAH21B	(1) 6-foot running board mounting bracket, 2021-2025 Chevrolet Tahoe
DRBKT-RB-UNIV	(1) Running board mounting bracket, universal

**Note**

- Vehicle-specific brackets sold separately

Distributed by Gross Automation | +1 (262) 252-1600 | sales@grossautomation.com



Effective January 19, 2026

DynaFlare™—Continued

MODEL	DESCRIPTION
<b>4-foot Models</b>	
DR4-RBW	(1) Red/Blue/White LEDs, Clear lens
DR4-BAW	(1) Blue/Amber/White LEDs, Clear lens
DR4-RAW	(1) Red/Amber/White LEDs, Clear lens
DR4-RBA	(1) Red/Blue/Amber LEDs, Clear lens
DR4-AGW	(1) Amber/Green/White LEDs, Clear lens
DR4-RGW	(1) Red/Green/White LEDs, Clear lens
DR4-RBW-SMK	(1) Red/Blue/White LEDs, Smoked lens
<b>3-foot Models</b>	
DR3-RBW	(1) Red/Blue/White LEDs, Clear lens
DR3-BAW	(1) Blue/Amber/White LEDs, Clear lens
DR3-RAW	(1) Red/Amber/White LEDs, Clear lens
DR3-RBA	(1) Red/Blue/Amber LEDs, Clear lens
DR3-AGW	(1) Amber/Green/White LEDs, Clear lens
DR3-RGW	(1) Red/Green/White LEDs, Clear lens
DR3-RBW-SMK	(1) Red/Blue/White LEDs, Smoked lens
<b>2-foot Models</b>	
DR2-RBW	(1) Red/Blue/White LEDs, Clear lens
DR2-BAW	(1) Blue/Amber/White LEDs, Clear lens
DR2-RAW	(1) Red/Amber/White LEDs, Clear lens
DR2-RBA	(1) Red/Blue/Amber LEDs, Clear lens
DR2-AGW	(1) Amber/Green/White LEDs, Clear lens
DR2-RGW	(1) Red/Green/White LEDs, Clear lens
DR2-RBW-SMK	(1) Red/Blue/White LEDs, Smoked lens
<b>1-foot Models</b>	
DR1-RBW	(1) Red/Blue/White LEDs, Clear lens
DR1-BAW	(1) Blue/Amber/White LEDs, Clear lens
DR1-RAW	(1) Red/Amber/White LEDs, Clear lens
DR1-RBA	(1) Red/Blue/Amber LEDs, Clear lens
DR1-AGW	(1) Amber/Green/White LEDs, Clear lens
DR1-RGW	(1) Red/Green/White LEDs, Clear lens
DR1-RBW-SMK	(1) Red/Blue/White LEDs, Smoked lens



**AVAILABLE  
Q2 2026**

Distributed by Gross Automation | +1 (262) 252-1600 | sales@grossautomation.com



# 416900 Series



- Low-profile perimeter light
- Single- and tri-color models
- (20) flash patterns
- Multi-voltage, 12/24 Vdc
- Black bezel for surface mounting or installed in a headlamp; Chrome or White bezel optional



**SINGLE- AND TRI-COLOR LED OPTIONS**



IP67



MODEL	DESCRIPTION
416912-A	Single-color, Amber LEDs, Clear lens
416912-B	Single-color, Blue LEDs, Clear lens
416912-R	Single-color, Red LEDs, Clear lens
416912-W	Single-color, White LEDs, Clear lens
416918-AGW	Tri-color, Amber/Green/White LEDs, Clear lens
416918-BAW	Tri-color, Blue/Amber/White LEDs, Clear lens
416918-RAW	Tri-color, Red/Amber/White LEDs, Clear lens
416918-RBA	Tri-color, Red/Blue/Amber LEDs, Clear lens
416918-RBW	Tri-color, Red/Blue/White LEDs, Clear lens
416918-RBW-SMK	Tri-color, Red/Blue/White LEDs, Smoked lens
<b>ACCESSORIES</b>	
416900BZ-C	Chrome bezel for 416900 Series Corner LED
416900BZ-W	White bezel for 416900 Series Corner LED
416900BZ-B	Black bezel for 416900 Series Corner LED
416900-VHB	3M™ VHB™ no-drill mount for Ford Interceptor Utility, 2020-2025 with standard headlight assembly and taillight when Ford option 86T is ordered, 4-pack

Distributed by Gross Automation | +1 (262) 252-1600 | sales@grossautomation.com



Effective January 19, 2026

# 416300 Series

- Flush mount perimeter warning light
- Single- and tri-color models
- (19) flash patterns
- Multi-voltage, 12/24 Vdc



**SINGLE- AND TRI-COLOR LED OPTIONS**

CCR  
TITLE 13

IP67

**WARRANTY**  
5  
**YEARS**

MODEL	DESCRIPTION
416303-A	Single-color, (3) Amber LEDs, Clear lens
416303-B	Single-color, (3) Blue LEDs, Clear lens
416303-R	Single-color, (3) Red LEDs, Clear lens
416303-W	Single-color, (3) White LEDs, Clear lens
416309-AGW	Tri-color, (9) Amber/Green/White LEDs, Clear lens
416309-BAW	Tri-color, (9) Blue/Amber/White LEDs, Clear lens
416309-RAW	Tri-color, (9) Red/Amber/White LEDs, Clear lens
416309-RBA	Tri-color, (9) Red/Blue/Amber LEDs, Clear lens
416309-RBW	Tri-color, (9) Red/Blue/White LEDs, Clear lens
416309-RBW-SMK	Tri-color, (9) Red/Blue/White LEDs, Smoked lens
<b>ACCESSORY</b>	
416302	Grommet kit, mounts (2) 416300 series in bottom of liftgate panel for auxiliary rear warning when liftgate is open, Chevrolet Tahoe, 2021-2025

Distributed by Gross Automation | +1 (262) 252-1600 | sales@grossautomation.com

# XStream®

- Versatile, low-profile interior mount, warning light
- Amber, Blue, Green, Red, and White
- Single-, dual-, or tri-color capability
- Single- or dual-head models
- (25) flash patterns and (10) color modes
- 12 Vdc
- Versatile mounting hardware included for dash/deck, headliner, and window mount applications







**TRI-COLOR LED OPTIONS**



MODEL	DESCRIPTION
XSM1-BRA-US	Single-head, Blue/Red/Amber, Wire leads
XSM1-BRW-US	Single-head, Blue/Red/White, Wire leads
XSM1-BWA-US	Single-head, Blue/White/Amber, Wire leads
XSM1-RWA-US	Single-head, Red/White/Amber, Wire leads
XSM1-WAG-US	Single-head, White/Amber/Green, Wire leads
XSM2-BRA-US	Dual-head, Blue/Red/Amber-Blue/Red/Amber, Wire leads
XSM2-BRW-US	Dual-head, Blue/Red/White-Blue/Red/White, Wire leads
XSM2-BWA-US	Dual-head, Blue/White/Amber-Blue/White/Amber, Wire leads
XSM2-RWA-US	Dual-head, Red/White/Amber-Red/White/Amber, Wire leads
XSM2-WAG-US	Dual-head, White/Amber/Green-White/Amber/Green, Wire leads

**ACCESSORIES AND KITS**

XSMBKT01	Slip-on visor mount kit for use with single- or dual-head models
XSMBKT02	Adjustable, swivel mount for single- or dual-head models
XSMBKT03	Universal headliner mount bracket for single- or dual-head models
XSMBKT07	Driver and passenger visor mount kit for use with (1) single- or dual-head XStream, with mounting holes for front and rear facing cameras, Dodge Charger, 2011-2023
XSMBKT10	Driver and passenger visor mount kit for use with (1) single- or dual-head XStream, with mounting holes for front and rear facing cameras, Ford F-250/350/450/550 Super Duty, 2017-2025, Ford Expedition, 2018-2025, Ford Lightning, 2022-2025
XSMBKT11	Driver and passenger visor mount kit for use with (1) single- or dual-head XStream, with mounting holes for front and rear facing cameras, Ford Police Interceptor Utility, 2020-2025
XSMBKT12	Driver and passenger visor mount kit for use with (1) single- or dual-head XStream, with mounting holes for front and rear facing cameras, Dodge Durango, 2011-2026
XSMBKT13	Driver and passenger rear window mount kit for use with (1) single- or dual-head XStream, Ford Ranger, 2019-2020
XSMBKT14	Driver and passenger visor mount kit for use with (1) single- or dual-head XStream, with mounting holes for front and rear facing cameras, Chevrolet Tahoe, 2021-2025
XSMBKT15	Driver and passenger visor mount kit for use with (1) single- or dual-color head XStream, with mounting holes for front and rear facing cameras, Ford Mustang, 2025
XSMBKT16	Driver and passenger visor mount kit for use with (1) single- or dual-head XStream, with mounting holes for front and rear facing cameras, RAM 1500 SSV, 2025
Z205003	Rubber extrusion



XSM2-BRW-US shown mounted in a vehicle



Each model includes light head, (2) suction cups, bail and pivot brackets, mounting hardware and three different length snap-on flash guards.

Distributed by Gross Automation | +1 (262) 252-1600 | sales@grossautomation.com

Effective January 19, 2026

# SignalTech® LED

- Round and oval flush mount lights available in flashing, stop/tail/turn, backup, and marker light
- Single-color models
- Random, alternating, or synchronous flash patterns
- Multi-voltage, 12/24 Vdc
- Kits include LED light, rubber mount grommet, and sealed wire harness



607123-02SB

607123-04SB

**SINGLE-COLOR LED OPTIONS**



CCR  
TITLE 13

FMVSS  
108



MODEL	DESCRIPTION
<b>4-Inch Round Flashing Light Kits</b>	
607123-02SB	PAR 36, Amp harness, Amber
607123-03SB	PAR 36, Amp harness, Blue
607123-04SB	PAR 36, Amp harness, Red
607123-05SB	PAR 36, Amp harness, White
<b>6-Inch Oval Flashing Light Kits</b>	
607101-02SB	Amp harness, Amber
607101-03SB	Amp harness, Blue
607101-04SB	Amp harness, Red
607101-05SB	Amp harness, White
<b>4-Inch Round STT/Turn/Backup Light Kits</b>	
607100-04SB	Stop/Tail/Turn light, Amp harness, Red
607102-02SB	Turn light, Amp harness, Amber
607124-05SB	Backup light, Amp harness, White
607124-05SB-DEU	Backup light, Amp harness, weather tight connector, White
<b>6-Inch Oval STT/Turn/Backup Light Kits</b>	
607105-04SB	Stop/Tail/Turn light, Amp harness, Red
607106-02SB	Turn light, Amp harness, Amber
607125-05SB	Backup light, Amp harness, White
607130-45SB	Combo Stop/Tail/Turn and Backup, Red and White
<b>Side Marker/Clearance Light Kits</b>	
607120-02SB	2.5 inch round, PL10 harness, Amber; -04SB (Red)
607119-02SB	2-inch round, Amp harness, Amber; -04SB (Red)
607120-02SB-AMP	2.5-inch round, Amp harness, Amber; -04SB-AMP (Red)
<b>Indicator Light</b>	
607121-04SB	1.5-inch flashing and steady, Red
<b>ACCESSORIES AND KITS</b>	
605501-02SB	6-inch oval flashing LED light head, Amber; -04 (Red)
605520SB	4-inch round, rubber mounting grommet
605510SB	6-inch oval, rubber mounting grommet
605523-02SB	4-inch round flashing LED light head, Amber; -03 (Blue); -04 (Red)
605500SB	Sealed wire harness for flashing LED light heads
605530SB	2.5-inch round mounting grommet



Distributed by Gross Automation | +1 (262) 252-1600 | sales@grossautomation.com

# LED Traffic-Clearing Light

- Exterior warning light available in two sizes
- Single-color models
- (10) flash patterns
- 6x4 model available as an option in the Navigator® light bar
- Multi-voltage, 12/24 Vdc
- Chrome bezel optional



LEDTCL64R-R



LEDTCL97C-W

**SINGLE-COLOR LED OPTIONS**



MODEL	DESCRIPTION
LEDTCL64A-A	6x4 (pair), Amber LEDs, Amber lens
LEDTCL64C-A	6x4 (pair), Amber LEDs, Clear lens
LEDTCL64C-B	6x4 (pair), Blue LEDs, Clear lens
LEDTCL64C-G	6x4 (pair), Green LEDs, Clear lens
LEDTCL64C-R	6x4 (pair), Red LEDs, Clear lens
LEDTCL64C-W	6x4 (pair), White LEDs, Clear lens
LEDTCL64R-R	6x4 (pair), Red LEDs, Red lens
LEDTCL64C-RB	6x4 (pair), (1) driver side Red LEDs, Clear lens and (1) passenger side Blue LEDs, Clear lens
LEDTCL97C-A	9x7, Amber LEDs, Clear lens
LEDTCL97C-B	9x7, Blue LEDs, Clear lens
LEDTCL97C-G	9x7, Green LEDs, Clear lens
LEDTCL97C-R	9x7, Red LEDs, Clear lens
LEDTCL97C-W	9x7, White LEDs, Clear lens
LEDTCL97R-R	9x7, Red LEDs, Red lens
<b>ACCESSORIES</b>	
QL97MC	9x7 Trim bezel, Chrome with gasket
QL64MC	6x4 Trim bezel, Chrome with gasket

Distributed by Gross Automation | +1 (262) 252-1600 | sales@grossautomation.com



Effective January 19, 2026

# Commander® LED Strip Lights

- 10" LED strip lights
- Available models include compartment and tank light
- Tank level light utilizes four colors to indicate tank level statuses



MODEL	DESCRIPTION
COMSTL-TANK	Tank light, (96) Amber/Blue/Green/Red LEDs, Clear lens
COMSTLS18C-W	Compartment light, (18) White LEDs, Frosted lens
<b>ACCESSORY</b>	
COMSTL-BKT	Mounting bracket for use with (1) COMSTL light

# Commander® COM1 Flashing/Marker Lights

- Multipurpose surface mount warning and marker lights
- Flashing models available with a single flash pattern or steady burn
- Chrome flange and mounting gasket included
- 12 Vdc



**SINGLE-COLOR LED OPTIONS**



MODEL	DESCRIPTION
COM1FC-A	Flashing light, Amber LEDs
COM1FC-R	Flashing light, Red LEDs
COM1MC-A	Marker light, Amber LEDs
COM1MC-R	Marker light, Red LEDs











Distributed by Gross Automation | +1 (262) 252-1600 | sales@grossautomation.com

# Latitude™

- Warning stick light
- Single-color
- 4-, 6-, and 8-head models
- (10) flash patterns
- 12 Vdc
- Wide range of external and internal mounting applications





**SINGLE-COLOR LED OPTIONS**





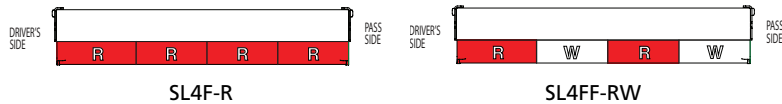

MODEL	DESCRIPTION
<b>4-Head Flashing Models</b>	
SL4F-2R2B	(2) Red light heads, (2) Blue light heads (alternating) R-B-R-B
SL4F-RB	(2) Red light heads, (2) Blue light heads, R-R-B-B
SL4F-R	(4) Red light heads, R-R-R-R
SL4F-B	(4) Blue light heads, B-B-B-B
<b>6-Head Flashing Models</b>	
SL6F-RB	(3) Red light heads, (3) Blue light heads, R-R-R-B-B-B
SL6F-R	(6) Red light heads, R-R-R-R-R-R
SL6F-B	(6) Blue light heads, B-B-B-B-B-B
SL6F-A	(6) Amber light heads, A-A-A-A-A-A, (does not include directional functions)
SL6FF-RW	(3) Red light heads, (3) White light heads, R-W-R-W-R-W (includes white light cut-off option)
<b>8-Head Flashing Models</b>	
SL8F-RB	(4) Red light heads, (4) Blue light heads, R-R-R-R-B-B-B-B
SL8F-R	(8) Red light heads, R-R-R-R-R-R-R-R
SL8F-B	(8) Blue light heads, B-B-B-B-B-B-B-B
SL8F-A	(8) Amber light heads, A-A-A-A-A-A-A-A, (does not include directional functions)

MODEL	DESCRIPTION
<b>ACCESSORIES AND KITS</b>	
320310	Kit, bracket, flush mount system
320320	Kit, bracket, double L-bracket
320330	Kit, bracket, system mount
320340	Kit, bracket, multi-vehicle mount
320350	Kit, bracket, foot adaptor
SLB-001	Kit, Long L-bracket
SLB-002	Kit, Short L-bracket
SLB-FRD15ND	8-head bracket, CN SignalMaster™ or Latitude, no drill, Ford F-150 2015-2025, Lightning 2022-2025, and Super Duty 2017-2025. Not for models with panoramic moon roof
SLB-SIL19ND	8-head bracket, CN SignalMaster or Latitude, no drill, Chevrolet Silverado, 2019-2025

### 4-HEAD CONFIGURATIONS



### 6-HEAD CONFIGURATIONS

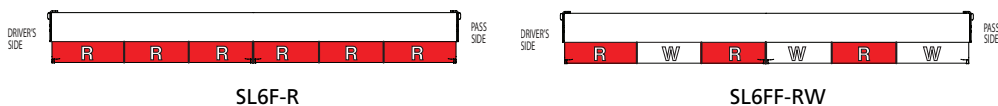

### 8-HEAD CONFIGURATIONS

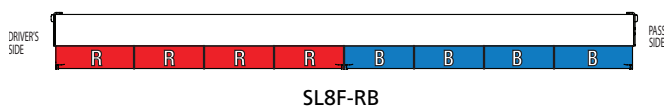





Distributed by Gross Automation | +1 (262) 252-1600 | sales@grossautomation.com

# Latitude™ SignalMaster™



- Directional warning stick light
- Available in 24", 32", and 48" lengths
- Single-color models
- 6- or 8-head models
- Left, right, and center-out directional signals; (1) flash pattern
- 12 Vdc
- SignalMaster economy controller included
- Wide range of external and internal mounting applications



**SINGLE-COLOR LED OPTION**









MODEL	DESCRIPTION
<b>6-Head SignalMaster Model</b>	
SL6S-A	24-inch, (6) Amber light heads, SignalMaster™ economy controller, 30-ft cable
<b>8-Head SignalMaster Models</b>	
SL8S-A	32-inch, (8) Amber light heads, SignalMaster™ economy controller
SL8S-A-50	32-inch, (8) Amber light heads, SignalMaster™ economy controller, 50-ft cable
SL8S-A48	48-inch, (8) Amber light heads, SignalMaster™ economy controller
SL8S-A48-50	48-inch, (8) Amber light heads, SignalMaster™ economy controller, 50-ft cable

**Note**

- SignalMaster brackets on page 62

# QuadraFlare® SignalMaster

- Directional warning stick light
- Available in 47" and 72" lengths
- Single-color models
- 6- or 8-head models
- Left, right, center-out directional signals
- 12 Vdc
- Controller required, purchased separately

**SINGLE-COLOR LED OPTIONS**





MODEL	DESCRIPTION
QL64SM47-6AC	47-inch, (6) Amber light heads, Clear lens, 30-ft cable
QL64SM72-8AC	72-inch, (8) Amber light heads, Clear lens, 30-ft cable

**Note**

- SignalMaster brackets on page 62



Distributed by Gross Automation | +1 (262) 252-1600 | sales@grossautomation.com

# CN SignalMaster™



- Directional warning light with flood light capability
- Available in 16" and 31" lengths
- Single-, dual-, and tri-color capability
- 4- and 8-head, and split 8-head models
- Left, right, and center-out directional signals; (27) flash patterns
- 12 Vdc
- Wide range of external and internal mounting applications

**LED COLOR OPTIONS**

MODEL	DESCRIPTION
<b>4-Head Front Model</b>	
CNSMJ4F-P3C	(4) Red/Blue/White light heads, no interface module
<b>8-Head Rear Models</b>	
CNSMJ8R-P1C	(4) Red/Amber light heads, (4) Blue/Amber light heads, no interface module
CNSMJ8R-P2C	(8) Blue/Amber light heads, no interface module
CNSMJ8R-P3C	(8) Red/Blue/Amber light heads, no interface module
CNSMJ8R-F1C	(8) Red/Amber light heads, no interface module
<b>Split 8-Head Rear Model</b>	
CNSMJ2X4R-P3C	(8) Red/Blue/Amber light heads, no interface module
<b>ACCESSORIES AND COMMON REPLACEMENT PARTS</b>	
Z1751531A	Splitter for network cables
Z858303641A	Interface module with cable assembly, FSJoin®

**Note**

- SignalMaster brackets on page 62

### 8-HEAD — REAR OF VEHICLE

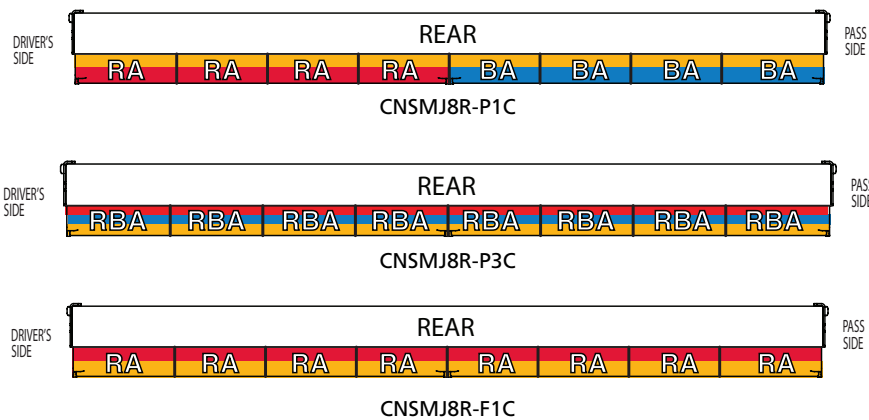

# MicroPulse® SignalMaster™

- Directional warning stick light
- Available in 20", 23", 30", 32", 36", 42", 44", 51", 65", and 84" lengths
- Single color; with or without Red brake lights (center)
- 4-, 6-, and 8-head models
- Left, right, center-out directional signals
- Controller features multiple user-selected warning patterns:  
(16) Full-featured controller model 331105-SB or (10) Basic controller model 330104-SB
- 12 Vdc
- Controller required, purchased separately



MPSUSM51-BRK-30



MPSUSM42-A-30

**SINGLE-COLOR LED OPTIONS**



MODEL	DESCRIPTION
MPSUSM23-A-30	23-inch, (4) Amber light heads, 30-ft cable
MPSUSM30-BRK-50	30-inch, (4) Amber light heads and (1) Red brake light (center), 50-ft cable
MPSUSM32-A-30	32-inch, (6) Amber light heads, 30-ft cable
MPSUSM32-A-60	32-inch, (6) Amber light heads, 60-ft cable
MPSUSM36-BRK-50	36-inch, (6) Amber light heads and (1) Red brake light (center), 50-ft cable
MPSUSM42-A-30	42-inch, (6) Amber light heads, 30-ft cable
MPSUSM42-BRK-30	42-inch, (6) Amber light heads and (1) Red brake light (center), 30-ft cable
MPSUSM42-A-60	42-inch, (6) Amber light heads, 60-ft cable
MPSUSM42-8A-30	42-inch, (8) Amber light heads, 30-ft cable
MPSUSM42-8A-60	42-inch, (8) Amber light heads, 60-ft cable
MPSUSM44-A-30	44-inch, (8) Amber light heads, 30-ft cable
MPSUSM44-A-60	44-inch, (8) Amber light heads, 60-ft cable
MPSUSM51-BRK-30	51-inch, (8) Amber light heads and (1) Red brake light (center), 30-ft cable
MPSUSM51-A-30	51-inch, (8) Amber light heads, 30-ft cable
MPSUSM51-A-60	51-inch, (8) Amber light heads, 60-ft cable
MPSUSM65-A-60	65-inch, (8) Amber light heads, 60-ft cable

**REQUIRED CONTROLLER OPTIONS**

330104-SB	Basic directional light controller, 12/24 Vdc
331105-SB	Full-feature directional light controller with slide switch and override feature, 12/24 Vdc

**COMMON REPLACEMENT PARTS**

ZMPS121UX-A-SM	Replacement light head, Amber
ZMPS121UX-R-SM	Replacement light head, Red

**Note**

- SignalMaster brackets on page 62



Distributed by Gross Automation | +1 (262) 252-1600 | sales@grossautomation.com

**SIGNALMASTER™ BRACKETS**

Distributed by Gross Automation | +1 (262) 252-1600 | sales@grossautomation.com



CNSM-RBK1

Mount kit for installing CN SignalMaster in Ford Police Utility, 2013-2025, internal use only



CNSM-TAH21

Kit to mount 4-head models to grille of Chevrolet Tahoe 2021-2025



CNSM-UM

Universal mount for installing CN SignalMaster, internal/external use



320310

Kit, bracket, flush mount system



320330

Kit, bracket, system mount



320340

Kit, bracket, universal vehicle mount



320350

Kit, bracket, foot adaptor

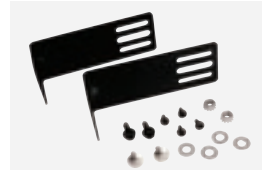

SLB-001

Kit, Long L-bracket

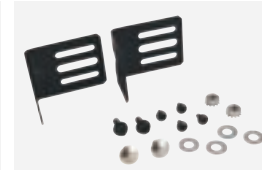

SLB-002

Kit, Short L-bracket



SLB-FRD15ND

8-head bracket for CN SignalMaster or Latitude™, no drill, Ford F-150 2015-2025, Lightning 2022-2025, and Super Duty 2017-2025. Not for models with panoramic moon roof



SLB-SIL19ND

8-head bracket for CN SignalMaster or Latitude™, no drill, Chevrolet Silverado 2019-2025

# MB1 LED Message Board



- Public safety message system with custom messaging capability
- (60) default messages, 1 MB memory for additional (500) custom messages
- PC software to create custom message sets included
- 12 Vdc
- Mount kits for specific vehicles or other Federal Signal brand light bars

**SINGLE-COLOR LED OPTIONS**



IP67



MODEL	DESCRIPTION
MB1	Blue LED message display and controller, 12 Vdc
MB1-A	Amber LED message display and controller, 12 Vdc
MB1-G	Green LED message display and controller, 12 Vdc
MB1-BNRW	Blue LED message display and controller, narrow mounting applications, 12 Vdc

**ACCESSORIES AND KITS**

MBK01	Kit for mounting MB1 to rear interior of Ford Police Interceptor Utility, 2013-2025
MBK03H	Kit for mounting MB1 message board to rear of Valor® light bars, hook mount only
MBK04	Kit for mounting MB1 to rear of Integrity®, Legend®, LPX and Navigator® light bars
MBK05	Kit for mounting MB1 to rear of Vision® SLR light bar
MBK06	Kit for mounting MB1-BNRW to rear interior of Dodge Durango 2011-2026

### EXAMPLES OF PRE-PROGRAMMED MESSAGES

### EXAMPLES OF DIFFERENT FONT CHOICES

(Messages can be customized for "steady-on," scrolling, flashing, multiple lines, scroll direction, scroll speed and Bold/Normal font)

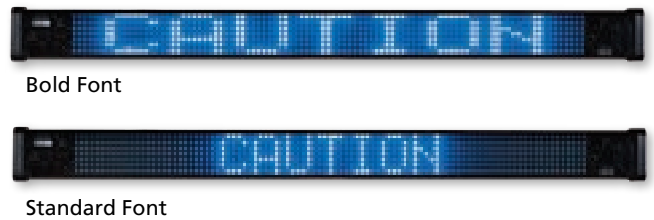

Message creation software



Control head



Distributed by Gross Automation | +1 (262) 252-1600 | sales@grossautomation.com

# Pro LED Beacon

- Versatile warning beacon for a variety of applications
- Short and tall domes available
- Single- and dual-color models
- (25) flash patterns
- Multi-voltage, 12/24 Vdc
- Built-in permanent/1" pipe mount aluminum diecast base



300TMPC-R-SB



**SINGLE- AND DUAL-COLOR LED OPTIONS**



MODEL	DESCRIPTION
300TMP-A-SB	Single-color, Amber LEDs, Tall Amber dome
300TMP-B-SB	Single-color, Blue LEDs, Tall Blue dome
300TMP-R-SB	Single-color, Red LEDs, Tall Red dome
300TMPC-A-SB	Single-color, Amber LEDs, Tall Clear dome
300TMPC-B-SB	Single-color, Blue LEDs, Tall Clear dome
300TMPC-G-SB	Single-color, Green LEDs, Tall Clear dome
300TMPC-R-SB	Single-color, Red LEDs, Tall Clear dome
320TMP-AB-SB	Dual-color, Amber/Blue LEDs, Tall Clear dome
320TMP-AG-SB	Dual-color, Amber/Green LEDs, Tall Clear dome
320TMP-AW-SB	Dual-color, Amber/White LEDs, Tall Clear dome
<b>ACCESSORY</b>	
300B-TALL	Branch guard, tall dome
300BKT-LB	L-bracket



300B-TALL

Distributed by Gross Automation | +1 (262) 252-1600 | sales@grossautomation.com





Effective January 19, 2026



# SLR Beacon

- Unique beacon with rotating LED reflector
- Single-color models
- (3) rotating speeds: 75/90/120 RPM
- Multi-voltage, 12/24 Vdc
- Built-in permanent/1" pipe mount aluminum diecast base



262650-02



**SINGLE-COLOR LED OPTIONS**









MODEL	DESCRIPTION
262650-02	Amber LEDs, Amber dome
262650-04	Red LEDs, Red dome
262650-05	White LEDs, Clear dome
262650-25	Amber LEDs, Clear dome

# IVP SLR

- Rotating beacon design complementing the Vision® SLR family of light bars
- Single-color models
- Multi-voltage, 12/24 Vdc



VSLR1-R1A02



**SINGLE-COLOR LED OPTIONS**





MODEL	DESCRIPTION
VSLR1-R1	Red LEDs, Red dome
VSLR1-R2	Red LEDs, Clear dome
VSLR1-A1	Amber LEDs, Amber dome
VSLR1-A2	Amber LEDs, Clear dome
VSLR1-G1	Green LEDs, Green dome
VSLR1-G2	Green LEDs, Clear dome
VSLR1-B1	Blue LEDs, Blue dome
VSLR1-B2	Blue LEDs, Clear dome

Distributed by Gross Automation | +1 (262) 252-1600 | sales@grossautomation.com

# NightSpire®

- Adjustable spot-to-flood light
- 360 degrees of continuous rotation
- 130 degrees of vertical tilt
- Wireless Bluetooth® or dash-mounted, ignition-powered, wireless controller with backlit buttons; each include (2) memory controls and pairs with up to (3) units
- 12 Vdc
- Permanent and magnet mount bases available



IP69K



MODEL	DESCRIPTION
NS200-P-SB	Permanent/1-inch pipe mount, battery-powered Bluetooth wireless controller
NS200-DM-SB	Permanent/1-inch pipe mount, ignition-powered Bluetooth wireless controller, dash mount kit included
NS200-DM2-SB	Permanent/1-inch pipe mount, ignition-powered Bluetooth wireless controller and battery-powered Bluetooth wireless controller, dash mount kit included
NS200-M-SB	Magnet mount, accessory plug, battery-powered Bluetooth wireless controller
ACCESSORIES AND COMMON REPLACEMENT PARTS	
200NS-ADPKT	Adaptor mount kit
200NS-TALL	Branch guard for permanent mount models
NSCTRL-1	Replacement battery-powered Bluetooth wireless controller
NSCTRL-BKT	Dash mount bracket for battery-powered Bluetooth wireless controller
Z843303374A	Clear dome
Z864901329	Bracket kit for mounting to Allegiant® Max/Integrity®



NightSpire mounted on Allegiant Max with Z864901329 bracket kit



Battery-powered wireless Bluetooth controller



Ignition-powered wireless Bluetooth controller

Distributed by Gross Automation | +1 (262) 252-1600 | sales@grossautomation.com





# Commander® 8" LED Interior Light

- Direct replacement for 8-inch halogen or incandescent lamps utilizing standard industry hole patterns and cutout dimensions
- Models available with chrome or white housings, including snap-in models
- Hi-Lo intensity inputs



GSA KKK-A-182F

WARRANTY 5 YEARS

MODEL	DESCRIPTION
COM8PTC	(18) LEDs, White, diffusing lens, Chrome housing

# Commander® Flex Light

- Ultra-thin, flexible strip lights to illuminate compartment spaces
- Cool White LEDs
- Multi-voltage, 12/24 Vdc
- 3M™ acrylic foam tape on back for easy installation; mounting clips and screws included



IP67

WARRANTY 3 YEARS

MODEL	DESCRIPTION
COMFLEX-9	9-inch, flexible compartment strip light, White LED
COMFLEX-18	18-inch, flexible compartment strip light, White LED
COMFLEX-27	27-inch, flexible compartment strip light, White LED
COMFLEX-36	36-inch, flexible compartment strip light, White LED
COMFLEX-45	45-inch, flexible compartment strip light, White LED
COMFLEX-54	54-inch, flexible compartment strip light, White LED
COMFLEX-63	63-inch, flexible compartment strip light, White LED

Distributed by Gross Automation | +1 (262) 252-1600 | sales@grossautomation.com



# Commander® 3" Compartment Light

- Standard 3" round surface mount compartment lights with an aluminum base
- Surface mount alleviates the need to do full body cutouts
- Low-profile design allows for versatile mounting options
- All models include bolt or adhesive mount for added flexibility in mounting
- Dual-color compartment lights allow for separate control of colors
- Red LED compartment lights are ideal for improved nighttime vision in compartments
- Chrome flange and rubber grommet available



MODEL	DESCRIPTION
COM3SWC	Single-color, (6) White LEDs, Clear lens
COM3SRWC	Dual-color, (3) White LEDs, (3) Red LEDs, Clear lens
ACCESSORIES AND KITS	
COM3FLANGEC	3-inch round chrome flange for COM3 lights
COM3GROMMET	Kit, Grommet for COM3 lights

# Commander® 5" LED Interior Light

- Low-profile, surface mount, interior dome or compartment light
- Cool White LEDs
- 12 Vdc
- Durable polycarbonate housing and sealed lens



MODEL	DESCRIPTION
COMINT5-W	5-inch, White LEDs, 380 Lumen



# Evacuator® Backup Alarms

- Backup alarm with dual-tone function
- Universal mounting bracket included
- Multi-voltage, 12-48 Vdc



SAE J994



MODEL	DESCRIPTION
	<b>Evacuator Plus, Dual Functions, 12/48 Vdc</b>
210330SSG	87 dB
210331SSG	97 dB
210333SSG	107 dB
210335SSG	112 dB

# 2012 Series Backup Alarm

- Dependable and economical backup alarm for variety of applications
- Multi-voltage, 12/24 Vdc
- Steam-cleanable and pressure-washable
- Built-in universal mount bracket



SAE J994



MODEL	DESCRIPTION
210238-W*	87 dB(A), wired, SAE J994 Type D
210239-S*	97 dB(A), stud terminal, SAE J994 Type C
210239-W*	97 dB(A), wired, SAE J994 Type C
210240-S*	102 dB(A), stud terminal, SAE J994 Type F
210240-W*	102 dB(A), wired, SAE J994 Type F

Distributed by Gross Automation | +1 (262) 252-1600 | sales@grossautomation.com



Effective January 19, 2026

# Opticom®

- Infrared and strobe traffic pre-emption emitters compatible with select Federal Signal light bars
- Transmission range up to 2,500 feet
- Weather-resistant encoded signal device
- Internal-mount and external-mount emitter available
- Models available with mounting brackets



MODEL	DESCRIPTION
795H-EXTB-D	GTT 795H emitter/bracket for attaching to driver-side of Valor®, Integrity®, Vision® SLR, Navigator®, Allegiant® Max, Reliant® S2 and Split Vision® SLR light bars
795H-EXTB-P	GTT 795H emitter/bracket for attaching to passenger-side of Valor, Integrity, Vision SLR, Navigator, Allegiant Max, Reliant S2 and Split Vision SLR light bars
794-AH	794 infrared LED emitter, suitable for external use

### Notes

- Opticom emitters must be mounted behind clear domes
- 795H-EXTB-D/-P are not intended for use with the Low-Profile mounting foot option

# Headlight/Taillight Flashers

- Vehicle-specific flashers for a variety of vehicles
- Multiple flash pattern options
- Plug-and-Play models allow for quick installation
- Vehicle-specific mounts available



FHL-TAIL



MODEL	DESCRIPTION
FHL-CHG	Flasher, Headlight, 2015-2026 Dodge Durango (fog only)
FHL-HL	Flasher, Headlight, positive-side switched systems, 18-inch wire leads, (2) 10 A outputs, multiple flash patterns
FHL-TAIL	Flasher, Taillight, universal applications, 18-inch wire leads

## Headlight/Taillight Flashers Vehicle Chart

VEHICLE	HEADLIGHT	TAILLIGHT
Ford Expedition (Halogen headlights only), 2018-2024	FHL-CHG	FHL-TAIL
Chevrolet Tahoe, 2021-2025	N/A	FHL-TAIL
Dodge Charger, 2015-2023	N/A	FHL-TAIL
Dodge Durango (Fog lights only), 2015-2026	FHL-CHG	FHL-TAIL
Ford Police Interceptor Utility, 2020-2025	N/A	FHL-TAIL
Ford F-150 (Halogen only), 2015-2025	FHL-CHG	FHL-TAIL



FHL-CHG



FHL-HL



Distributed by Gross Automation | +1 (262) 252-1600 | sales@grossautomation.com

# Atkinson Dynamics® Intercoms

- Rugged and reliable intercom system to receive, amplify, and send signals
- Two- or three-way communication
- Integrated filtering to reduce outside noise and interference
- Push-to-talk and hands-free intercom models can be paired with flush, swivel, or wall mount speakers and hand-held microphone
- Multi-voltage, 12/24 Vdc
- Sealed, corrosion-resistant cast aluminum housing



MODEL	DESCRIPTION
<b>Intercoms</b>	
AD26-Z	Push to talk, 12/24 Vdc
AD26-8-M44-Z	Push to talk, pre-amplifier, remote volume, 12/24 Vdc, use with ADSS-25 or ADSF-25
AD26C-Z	Master intercom, push to talk, 12/24 Vdc, use with hands-free intercom
AD26C-1-Z	12/24 Vdc, master intercom, power audio in single cable
AD26C-7-Z	Master intercom, push to talk, microphone ready, 12/24 Vdc, use with hands-free intercom
AD26D-Z	Hands-free intercom, defaults to talk mode, 12/24 Vdc, use with master intercom
AD26D-1-Z	12/24 Vdc, auxiliary intercom, use with AD26C-1-Z
<b>Speakers</b>	
ADSF-25-Z	25 W, flush mount
ADSS-25-Z	25 W, swivel mount
ADSV-25-Z	25 W, wall mount with volume control

## BASIC SYSTEMS

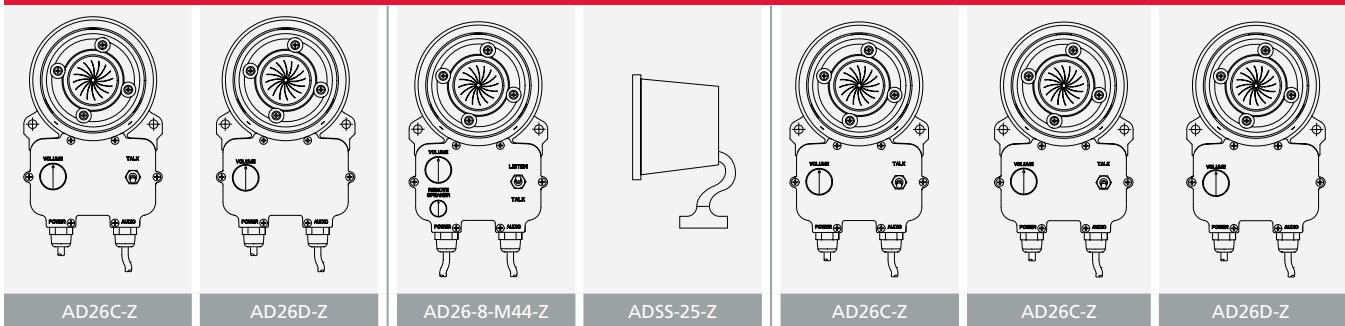

Distributed by Gross Automation | +1 (262) 252-1600 | sales@grossautomation.com



Effective January 19, 2026

# Littlite® LED

- Flexible, gooseneck task light
- UV light model is ideal for checking security watermarks on driver's licenses, passports, and currency
- 12" and 18" lengths available
- Available with an on/off switch or rheostat dimmer control
- Includes 24" of automotive wiring for installation



MODEL	DESCRIPTION
<b>Horizontal Mount - neck extends from top of chassis</b>	
LF12TSB-LED	12-inch, On/Off switch control, wired base
LF12TS-LED	12-inch, On/Off switch control
LF18TSB-LED	18-inch, On/Off switch control, wired base
LF18TSB-LED-BLUE	18-inch, On/Off switch control, wired base, Blue
LF18TS-LED	18-inch, On/Off switch control
<b>Vertical Mount - neck extends from end of chassis</b>	
LF12ES-LED	12-inch, On/Off switch control
LF18ES-LED	18-inch, On/Off switch control
LF12ESB-LED	12-inch, On/Off switch control, wired base
LF18ER-LED-UV	18-inch, Rheostat control, UV/White/Red light modes

# Voice Gun

- High-power, lightweight, handheld electronic megaphone
- Versatile applications
- Excellent sound quality
- Made of high-impact, flame-retardant plastic
- Operates on (8) AA batteries, not included
- Audio range up to 1,320 feet



MODEL	DESCRIPTION
A12SA	16 W, 1320-ft range, requires (8) AA batteries



Distributed by Gross Automation | +1 (262) 252-1600 | sales@grossautomation.com

# LIMITED WARRANTY POLICY

Effective January 19, 2026

Federal Signal Corporation ("Federal Signal"), subject to the terms, conditions and exceptions contained herein, warrants each NEW product to be free from defects in material and workmanship, under normal and proper use, care, maintenance and required service only. Start of Warranty, Warranty periods and exceptions to the foregoing Limited Warranty are contained on the Schedule of Products included in this document and are subject to change at the sole discretion of Federal Signal.

### SPECIFIC EXCLUSIONS AND EXCEPTIONS

This Limited Warranty does NOT apply nor is it extended to products that are not manufactured by Federal Signal. These products may be covered by a separate limited warranty provided by the particular manufacturer, and all claims and questions regarding the same are to be directed to the particular manufacturer. Goods sourced by Seller from a third party for resale to Buyer shall carry only the warranty extended by the original manufacturer.

Domes, lenses, lamps, and batteries installed on Federal Signal products are specifically excluded. Repair or replacement of any product(s) or part(s) under this warranty does NOT extend the term of this warranty, and such product(s) or part(s) shall remain covered by the unexpired portion of the warranty period or for ninety (90) days from the date of return to Federal Signal, whichever is later. This limited warranty applies ONLY to the initial or first installation of the product. This limited warranty shall not apply to products (1) that have been subjected to neglect, abuse, misuse, improper installation, inadequate maintenance, or damage due to improper use of cleaning or cleaning materials or chemicals, or non-compliance with Federal Signal's storage, installation, operation, maintenance or environmental requirements; (2) that have undergone any modification or repair not previously authorized by Federal Signal in writing, or service, repair or modification by or from any facility other than an authorized Federal Signal service center or technician, or that use non-authorized software or spare or replacement parts; or (3) that fail due to reasonable and normal use or wear and tear, or materials made, furnished, or specified by the Buyer or end user.

During the specific warranty periods set forth below, Federal Signal will, at its sole option, repair or replace the product(s) or particular part(s) that are found to be defective in either material or workmanship or, in its sole discretion, refund the purchase price for such product(s) or part(s), which are returned or delivered, transport or shipping prepaid by the Buyer or end user, to either Federal Signal or its designated and authorized warranty service center. This limited warranty does not cover travel expenses, the cost of specialized equipment for gaining access to the product(s) or part(s), or labor charges for removal and re-installation of the product.

No person or affiliated company representative is authorized to alter the terms of this warranty, to give any other warranties, to extend the term or duration of this warranty, or to assume any other liability on behalf of Federal Signal in connection with the sale, servicing, or repair of any product manufactured by the Federal Signal.

Federal Signal reserves the right to make design changes and improvements in its products without imposing any obligation upon itself to change or improve previously manufactured products.

The use in the product of any part other than parts approved by Federal Signal may invalidate this warranty. Federal Signal reserves the right to determine, in its sole discretion, if the use of non-approved parts invalidates this warranty.

THIS WARRANTY IS IN LIEU OF ALL OTHER WARRANTIES, EXPRESS OR IMPLIED, INCLUDING, WITHOUT LIMITATION, WARRANTIES OF MERCHANTABILITY AND FITNESS FOR A PARTICULAR PURPOSE, AND REGARDLESS OF ANY FAILURE OF ESSENTIAL PURPOSE. ALL OTHER WARRANTIES OF WHATSOEVER KIND AND NATURE, WHETHER EXISTING IN CONTRACT OR AT LAW, ARE HEREBY AND FOREVER DISCLAIMED.

UNDER NO CIRCUMSTANCES WILL FEDERAL SIGNAL BE LIABLE OR RESPONSIBLE FOR SPECIAL, COMPENSATORY, INCIDENTAL, CONSEQUENTIAL OR PUNITIVE DAMAGES, LOST PROFITS, LOST SALES, OR LOSS OF USE OR LOSS OF BUSINESS OPPORTUNITY BY OR THROUGH THE USE OF THE PRODUCT. FEDERAL SIGNAL'S SOLE AND MAXIMUM LIABILITY WITH RESPECT TO THE PRODUCT, OTHER THAN ITS OBLIGATIONS SET FORTH ABOVE, SHALL BE THE TOTAL PURCHASE PRICE PAID FOR THE PRODUCT.

Distributed by Gross Automation | +1 (262) 252-1600 | sales@grossautomation.com



LIMITED WARRANTY— Schedule of Products  
Effective January 19, 2026

**Federal Signal Corporation – Public Safety Systems Division (Police, Fire/EMS, Work Truck)**

	Warranty Period for Parts replacement from the date of manufacture stamped on the product	Warranty period for Factory Labor from the date of delivery to the first user-purchaser
<b>STANDARD WARRANTY COVERAGE</b>		
<b>AUDIBLE</b>		
Speakers	2 years	1 year
Pathway™	5 years	5 years
Pathfinder®	5 years	5 years
<b>LED PRODUCTS</b>		
All LED (Light Emitting Diode) products unless otherwise noted	5 years	5 years
MicroPulse® LED lights (shipped prior to January 1, 2021)	3 years	3 years
MicroPulse® LED lights (shipped on or after January 1, 2021)	5 years	5 years
416300 Series (shipped prior to January 1, 2021)	3 years	3 years
416300 Series (shipped on or after January 1, 2021)	5 years	5 years
MB1 LED Message Board	3 years	3 years
Commander® Series Flex	3 years	3 years
4200S-A Perimeter Light	3 years	3 years
4200S/8200S SignalMaster™	3 years	3 years
SignalTech® Lights	3 years	3 years
ICON® Series	3 years	3 years
Renegade LED	3 years	3 years
Firebolt LED Class 3	3 years	3 years
<b>OTHER PRODUCTS</b>		
Littlite® Map lights	5-year warranty on LED components Limited lifetime warranty on mechanical components	5-year warranty on LED components Limited lifetime warranty on mechanical components
Reverse Camera Systems	2 years	2 years
Stinger Spike Systems	5 years	5 years
DFC Series Push Bumper	3 years	3 years
FSLink® Programmer	1 year	1 year
Atkinson Dynamics® Intercoms	2 years	1 year
Switch Boxes SW200, SW300, SW400SS	3 years	3 years
Mounting Bar	3 years	3 years
Littlite Platform Series	3 years	3 years
Convergence Network Controllers & Relay Modules	3 years	3 years
FSDirect™ Control Module	5 years	5 years
Backup Alarms	3 years	3 years
Mounts, brackets, all other products not specifically listed below	3 years	3 years

NOTE: Domes, lenses, lamps, and batteries are NOT covered under warranty.



Distributed by Gross Automation | +1 (262) 252-1600 | sales@grossautomation.com



# FEDERAL SIGNAL STRENGTH™

Every moment of every day, we go beyond the call. Every decision driven by the safety of you and your community. Take comfort in our commitment to engineer the most reliable, durable, and high-performing products for your emergency vehicle.



## SAFETY IN THIS MOMENT.

### EXCLUSIVE TECHNOLOGIES TO KEEP YOUR COMMUNITY SAFE. THAT'S FEDERAL SIGNAL STRENGTH.™



**FS CONVERGENCE NETWORK** enables true plug-and-play installation and programming.



**FSLINK**® is an embedded software technology that utilizes a shared set of flash patterns and a common five-conductor cable to flash the patterns of Federal Signal's mini-light bars, beacons, and warning devices simultaneously or alternately.



**FSJOIN**® is a programming feature designed to enhance customization across Federal Signal's visual and audible vehicle warning products.



**HOTFOOT**® lighted mounting feet accommodate LED takedown and alley lights.



**SPECTRALUX**® multicolor LED technology provides the ability for a single light head to change color while in operation.



**ROC (RELIABLE ONBOARD CIRCUITRY™)** technology eliminates approximately 85% of connection failure points found in a typical light bar.



**RUMBLER**® Ideal for dense urban environments, Rumbler® is a low-frequency siren that works simultaneously with a primary siren tone to penetrate solid material, allowing vehicle operators and nearby pedestrians to feel the sound waves.



**SLR (SOLARIS® LED ROTATOR)** maximizes the LED light source for full light coverage. SLR rotators provide rotating, oscillating, flashing, and flood light functionality.



**SOLARIS® LED** reflector technology maximizes optical efficiency and provides superior off-axis warning.



**V-SHAPE**® light bar is mechanically designed to have a non-linear shape (V-Shape), providing an advantage in terms of off-axis warning performance compared to light bars with a traditional linear shape.



**Q-SIREN**® The sound of the Q-Siren® is a registered trademark of Federal Signal Corporation, and it provides a distinct, recognizable long-distance warning.

“It’s not a fire truck unless it’s got a **Q-Siren®!**”



There is no mistaking the **iconic sound** of the

## **Federal Signal Q-Siren®**

Introduced in 1951, its unmistakable tone quickly became a defining sound of the American fire service — signaling urgency long before a fire truck came into view. Its polished chrome housing reflected the craftsmanship of mid-century apparatus builders, preserving a sense of pride and tradition. For generations of firefighters, the Q-Siren has been more than equipment—it has been a symbol of service, heritage, and the enduring spirit of the firehouse.

We continue to bring that same unmatched craftsmanship to every Q-Siren, honoring the dedicated professionals who serve our communities.



In 2026, each Q-Siren will feature an exclusive etching commemorating **75 years of safety.**

2645 Federal Signal Drive  
University Park, IL 60484  
(708) 534-3400

[www.fedsig.com](http://www.fedsig.com)



### **Customer Support**

(800) 264-3578  
[policefireorders@fedsig.com](mailto:policefireorders@fedsig.com)

### **Service Department**

(800) 433-9132  
[empserviceinfo@fedsig.com](mailto:empserviceinfo@fedsig.com)

Chevrolet®, Chrysler®, Dodge®, Durastar®, Ford®, General Motors®, Jeep®, Nissan®, RAM®, and Toyota® are registered trademarks of their respective owners and are displayed only to show fit and compatibility, not as indicators of source, origin, endorsement, sponsorship, or affiliation.

Littlite and Opticom are trademarks of its respective owner.

All others indicated are trademarks of Federal Signal Corporation.

©2025 Federal Signal Corporation. All rights reserved worldwide.