

---

CATALOG

**Carlon®**

Enclosures and junction boxes



---

**Thomas & Betts is now ABB Installation Products, but our long legacy of quality products and innovation remains the same. From connectors that help wire buildings on Earth to cable ties that help put machines in space, we continue to work every day to make, market, design and sell products that provide a smarter, safer and more reliable flow of electricity, from source to socket.**

---

# Table of contents

<b>004</b> –011	<b>Carlton® non-metallic junction boxes</b>
<b>012</b> –021	<b>Circuit Safe® NEMA enclosures</b>
<b>022</b> –026	<b>Circuit Safe® JIC enclosures</b>
<b>027</b> –030	<b>Circuit Safe® pushbutton enclosures</b>
<b>031</b> –034	<b>Circuit Safe® enclosure accessories</b>
<b>035</b> –049	<b>Himeline® enclosures</b>
<b>050</b> –052	<b>Slack and splice enclosures</b>
<b>053</b> –062	<b>Technical information</b>

# To give you a better way to install parking lot lights we started at the bottom

## Curved lid J-box

Curved lid J-box anyone who's worked with parking lot light poles knows the problem. Those tiny, integral hand holes for electrical wiring can really slow a project down. But now, there's a better answer for shopping centers, car dealerships, sports arenas, office complexes or anywhere you need pole lighting for large parking lot areas – the Carlon® non-metallic curved lid J-Boxes.



Carlon® curved lid J-Boxes are listed in accordance with UL 50 specifications for Electrical Enclosures as well as NEMA 1, 2, 3, 3R, 3S, 4, 4X, 12 and 13 ratings. They are available in sizes 8" x 8" or 12" x 12". Both the base and lid are made from PVC to eliminate rust and corrosion, and both are supplied with tamper-resistant screws.

Designed specifically for use with 24" diameter concrete piers, J-Boxes are installed, along with all necessary conduit and fittings, when piers are poured. This gives installers a giant junction box at the base of every pole to ease wiring, facilitate circuit management and provide easy post-installation maintenance. Just take a closer look, and you'll see why our non-metallic J-Boxes are a better choice for you.

## Install Carlon® Weatherproof covers

### Features and benefits:

- NEMA 1, 2, 3, 3R, 3S, 4, 4X, 12, 13
- UL® Listed and CSA Certified
- Paintable lid
- Dividers available to separate high and low voltage, and can be retrofitted into existing applications
- Lids provide locations to mount weatherproof covers:
  - 8" x 8" – one location
  - 12" x 12" – three locations
- Nonconductive and noncorrosive
- Designed for a 24" diameter concrete pier

Note: The J-box can also be installed in concrete piers from 18" to 36" in diameter.  
Contact your Thomas & Betts representative for installation details.



- 01 Site lighting plan with J-box
- 02 Site lighting plan without J-box

**Faster, easier wiring for greater productivity**

Once your J-Boxes are installed, you can speed projects along by pre-wiring before poles arrive. Or, you can install poles first and use them to mount cable-pulling equipment – a particular advantage for long, difficult wire pulls. Of course, all the extra hand room our J-Boxes offer makes splicing much easier and faster than working through cramped pole-access holes.



**More flexibility, fewer home runs and easier maintenance, too**

Extra room also gives you splicing space for options like zone lighting or to reduce the number of home runs, which can lower trenching and associated materials costs by up to 30%.

In addition, the box lids provide locations to mount receptacles and weatherproof covers for even more flexibility. For easy maintenance, fixture protection can be placed at the base, and if need be, poles can even be removed and replaced in the middle of the circuit without affecting overall lighting.

- 03 J-box, with all conduit and fittings placed as desired, is temporarily attached to the concrete form – base and lid inside.

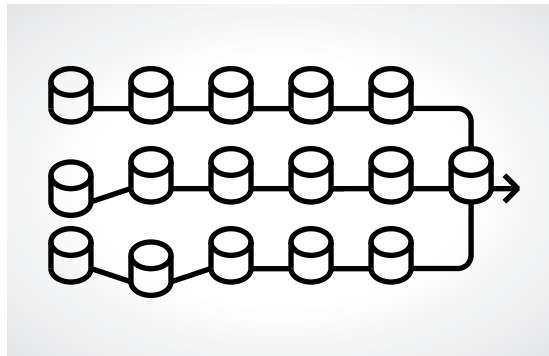

01

- 04 Remove form after concrete has been poured and allowed to cure.

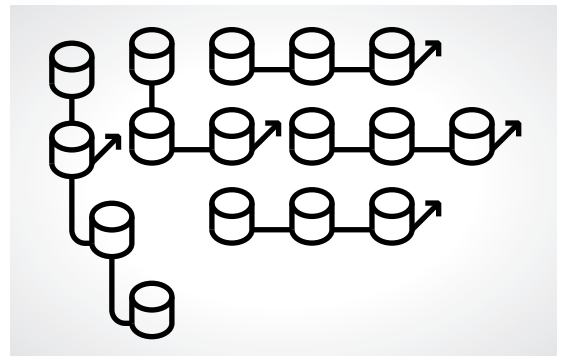

02

- 05 Pop off the J-box lid, leaving an 8" x 8" x 4" or 12" x 12" x 4" access area, depending on the J-box selected.

- 06 After wiring is completed, the lid is replaced to complete the installation.

Easy to install



03



04



05



06

## J-Box

### Assemblies



Cat. No.	Size (in.)	Std. Ctn.	Std. Wt. (lbs.)
E88C24	8 x 8 x 4	6	28.3
E1212C24	12 x 12 x 4	2	9.7

## Accessories



### Replacement lids

Cat. No.	Size (in.)	Std. Ctn.	Std. Wt. (lbs.)
E88L24	8 x 8	1	2.1
E1212L24	12 x 12	1	2.3



J-Box dividers are used to separate high- and low-voltage devices and solvent cement into place.

### Dividers

The National Electrical Code® (NEC®) allows electrical conductors to share an outlet box when the conductors and communication cables are separated by a barrier within the box.

Cat. No.	Std. Ctn.	Std. Wt. (lbs.)
▶ E88DIV (For use with CAT. NO. E88C24)	6	2.1
▶ E1212DIV (For use with CAT. NO. E1212C24)	2	2.3

NEC and National Electrical Code are registered trademarks of the National Fire Protection Association, Inc.

## Molded non-metallic boxes

6P rated

Non-metallic junction boxes are UL Listed with a NEMA 6P rating per Section 314.29, Exception of the National Electrical Code® and CSA Certified per Section 12 of the Canadian Electrical Code. Manufactured from PVC or PPO thermoplastic molding compound and featuring foam in-place gasketed lids attached with stainless steel screws, these rugged enclosures offer all the corrosion resistance and physical properties you need for direct-burial applications.

Type 6P enclosures are intended for indoor or outdoor use, primarily to provide a degree of protection against contact with enclosed equipment, falling dirt, hose-directed water, entry of water during prolonged submersion at a limited depth and external ice formation.

### Features and benefits:

- All Carlon® junction boxes are UL Listed/CSA Certified and maintain a minimum of a NEMA Type 4/4X Rating

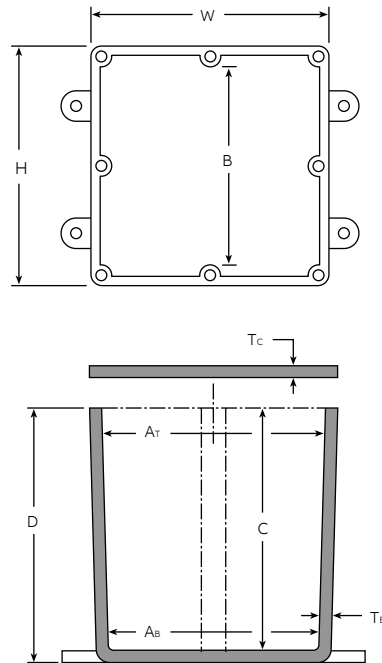

Molded non-metallic junction boxes – 6P rated

Cat. No.	Size H x W x D (in.)	Std. Ctn.	Dimensions (in.)					Material			Std. Wt.(lbs.)
			Min. AT	Min. AB	Min. B	Min. C	T <sub>B</sub>	T <sub>C</sub>	PVC	Thermo- plastic	
E989NNJ*	4 x 4 x 2	10	3 <sup>11</sup> / <sub>16</sub>	3 <sup>5</sup> / <sub>8</sub>	N/A	2	0.160	0.155	X		3
E987N*	4 x 4 x 4	10	3 <sup>11</sup> / <sub>16</sub>	3 <sup>1</sup> / <sub>2</sub>	N/A	4	0.160	0.155	X		4
▶ E989NNR*	4 x 4 x 6	10	3 <sup>11</sup> / <sub>16</sub>	3 <sup>3</sup> / <sub>8</sub>	N/A	6	0.160	0.200	X		5
E989PPJ*	5 x 5 x 2	10	4 <sup>11</sup> / <sub>16</sub>	4 <sup>1</sup> / <sub>2</sub>	N/A	2	0.110	0.150		X	3
E987R-CAR*	6 x 6 x 4	2	6	5 <sup>5</sup> / <sub>8</sub>	N/A	4	0.190	0.190		X	3
E989RRR-UPC*	6 x 6 x 6	8	5 <sup>5</sup> / <sub>8</sub>	5 <sup>3</sup> / <sub>8</sub>	N/A	6	0.160	0.150		X	14
E989N-CAR	8 x 8 x 4	1	8	8	N/A	4	0.185	0.190		X	2
E989SSX-UPC	8 x 8 x 7	2	7 <sup>21</sup> / <sub>32</sub>	7 <sup>5</sup> / <sub>16</sub>	N/A	7	0.160	0.150		X	6
E989UUN	12 x 12 x 4	3	11 <sup>5</sup> / <sub>8</sub>	11 <sup>1</sup> / <sub>2</sub>	11 <sup>1</sup> / <sub>8</sub>	4	0.160	0.150		X	12
E989R-UPC	12 x 12 x 6	2	11 <sup>15</sup> / <sub>16</sub>	11 <sup>7</sup> / <sub>8</sub>	11 <sup>7</sup> / <sub>16</sub>	6	0.265	0.185		X	10

\* UL Listed  
NEC and National Electrical Code are registered trademarks of the National Fire Protection Association, Inc.

## Large PVC junction boxes

### NEMA 4X

Large PVC junction boxes are fabricated from Type II PVC sheet using a unique technology. Reduce the use of steel boxes and keep your wiring connections clean, safe and dry using these high-quality, fully gasketed junction boxes.

#### Features and benefits:

- PVC Type II material with “Uni-Body” construction and penetration welding providing a very strong, durable enclosure
- UL94V-0 flame rating
- Suitable for exposure of up to 90° C
- PVC material enables the use of standard solvent cements for fitting attachment
- Junction boxes are available with or without mounting flanges
- Individual mounting feet are available and provided in kits of four
- Custom features such as windows or panel mounts are available
- Custom sizes are also available upon request
- Made in the USA

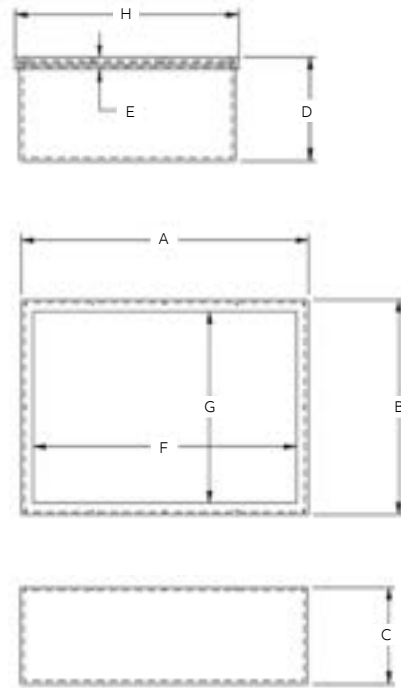
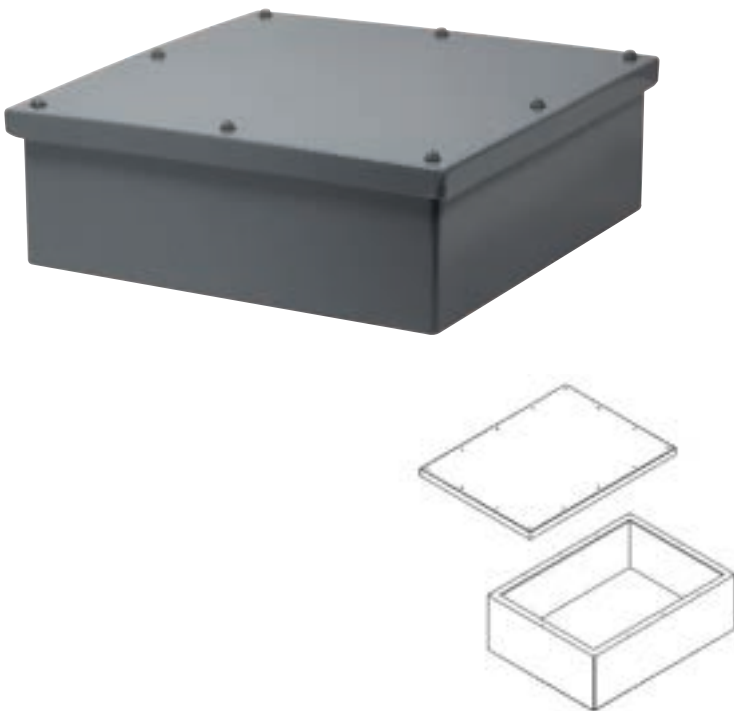

#### Large PVC junction boxes – NEMA 4X

Cat. No.	Dimensions (in.)								Std. Wt. (lbs.)
	A	B	C	D	E	F	G	H	
EP12128	12	12	8	8.25	1.00	10.5	10.5	12.75	11
EP181812	18	18	12	12.25	1.00	16	16	18.75	21
EP201808	20	18	8	8.25	1.00	18	16	18.75	20
EP202008	20	20	8	8.25	1.00	18	18	20.75	22
EP241808	24	18	8	8.25	1.00	22	16	18.75	24
EP242008	24	20	8	8.25	1.00	21.5	17.5	20.75	25
EP242408	24	24	8	8.25	1.00	21.5	21.5	24.75	29
EP302408	30	24	8	8.25	1.00	27.5	21.5	24.75	34
EP362408	36	24	8	8.25	1.00	33.5	21.5	24.75	39

#### Accessories

Cat. No.	Description	Std. Wt. (lbs.)
ESMFK-1	“CleverMount” mounting feet (Four feet and fasteners)	5

# Single-gang

## FS Device boxes

**Features and benefits:**

- For dead-end terminations
- All sizes take standard covers and accessories or devices
- Integral mounting feet provide easy mounting

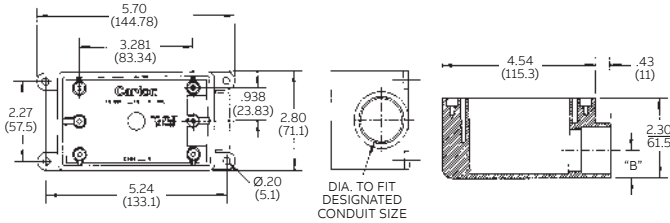

Type FSE

	Cat. No.	Size (in.)	Vol. Cu. (in.)	Std. Ctn.
	E980DFN	1/2	19	10
	🇨🇦 C980DFN-CTN	1/2	18	12
	E980EFN	3/4	19	10
	🇨🇦 C980EFN-CTN	3/4	18	12
	E980FFN	1	19	18
	🇨🇦 C980FFN-CTN	1	18	8
	E980FFN-CAR	1	19	10

🇨🇦 Canada only.

**Features and benefits:**

- For through terminations
- All sizes take standard covers and accessories or devices
- Integral mounting feet provide easy mounting

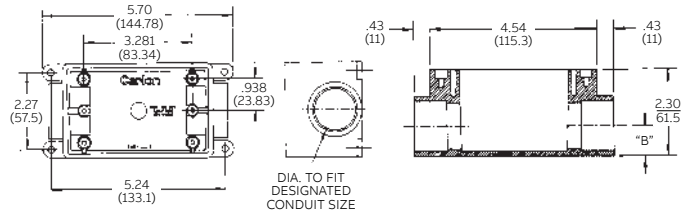

Type FSC

	Cat. No.	Size (in.)	Vol. Cu. (in.)	Std. Ctn.
	E981DFN	1/2	19	15
	🇨🇦 C981DFN-CTN	1/2	18	12
	E981EFN	3/4	19	15
	🇨🇦 C981EFN-CTN	3/4	18	12
	E981FFN	1	19	18
	E981FFN-CAR	1	19	10
	🇨🇦 C981FFN-CTN	1	18	8

🇨🇦 Canada only.

**Features and benefits:**

- For multiple dead-end circuit terminations or where additional support is required in stub-up applications
- All sizes take standard covers and accessories or devices
- Integral mounting feet provide easy mounting

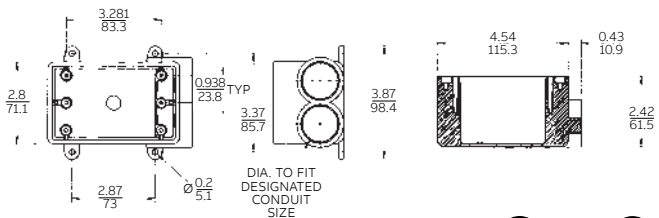

Type FSS

	Cat. No.	Size (in.)	Vol. Cu. (in.)	Std. Ctn.
	E982DFN	1/2	19	10
	🇨🇦 C982DFN-CTN	1/2	18	12
	E982EFN	3/4	19	10
	🇨🇦 C982EFN-CTN	3/4	18	12
	E982FFN	1	19	10
	🇨🇦 C982FFN-CTN	1	18	8

🇨🇦 Canada only.

**Features and benefits:**

- For multiple through-circuit terminations or where additional support is required in stub-up applications
- All sizes take standard covers and accessories or devices
- Integral mounting feet provide easy mounting

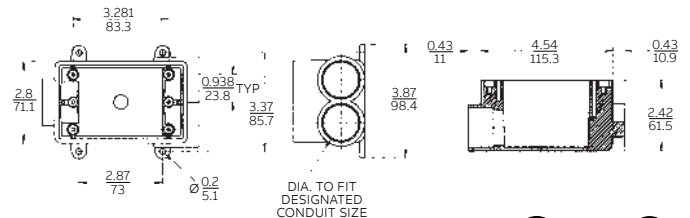

Type FSCC

	Cat. No.	Size (in.)	Vol. Cu. (in.)	Std. Ctn.
	E979DFN-CAR	1/2	19	10
	🇨🇦 C979DFN	1/2	18	15
	E979EFN-CAR	3/4	19	10
	🇨🇦 C979EFN	3/4	18	15
	E979FFN	1	19	15
	🇨🇦 C979FFN	1	18	15

🇨🇦 Canada only.

## Single-gang FD

### Deep device boxes

**Features and benefits:**

- For terminations where hub requirements vary according to application – hubs easily made with flared wood bit or hole saw
- All sizes take standard covers and accessories or devices
- Integral mounting feet provide easy mounting

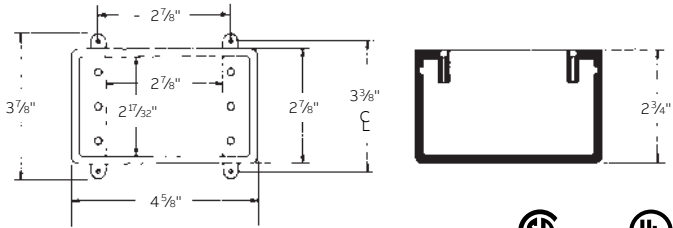

Type FD

Cat. No.	Size (in.)	Vol. Cu. (in.)	Std. Ctn.
E9801	N/A	25	10
☛ CE9801-CTN	N/A	25	10
☛ C9801-347	N/A	25	10

☛ Canada only.

**Features and benefits:**

- For dead-end terminations where large devices or additional wiring capacity is required
- All sizes take standard covers and accessories or devices
- Integral mounting feet provide easy mounting

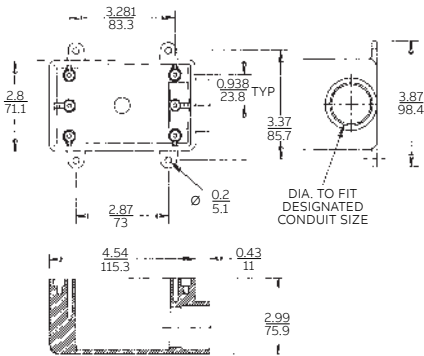

Type FDE

Cat. No.	Size (in.)	Vol. Cu. (in.)	Std. Ctn.
E9801DN	1/2	25	10
☛ C9801DN	1/2	25	10
E9801EN	3/4	25	10
☛ C9801EN	3/4	25	10
E9801FN	1	25	10
☛ C9801FN	1	25	10

☛ Canada only.

**Features and benefits:**

- For through terminations where large devices or additional wiring capacity is required
- All sizes take standard covers and accessories or devices
- Integral mounting feet provide easy mounting

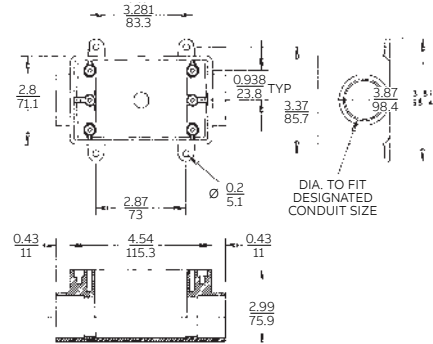

Type FDC

Cat. No.	Size (in.)	Vol. Cu. (in.)	Std. Ctn.
E9811DN	1/2	25	10
☛ C9811DN	1/2	25	10
E9811EN	3/4	25	10
☛ C9811EN	3/4	25	10
E9811FN	1	25	10
☛ C9811FN	1	25	10

☛ Canada only.

## Blank covers

### For single-gang device boxes

**Features and benefits:**

- Fits Carlon® single-gang FS boxes
- Supplied with stainless steel mounting screws and gasket

Cat. No.	Color	Std. Ctn.	Std. Wt. (lbs.)
E980CN-CAR	Gray	12	1.60
E980CM-CAR	White	12	1.60

## Two-gang FS Device boxes

### Features and benefits:

- For through terminations where two devices or additional wiring capacity is required
- All sizes take standard covers and accessories or devices
- Integral mounting feet provide easy mounting

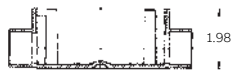
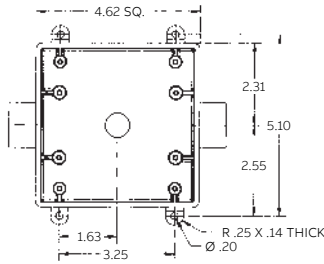

LR31146  
Where noted by



E11461

Type 2FSC

Cat. No.	Size (in.)	Vol. Cu. (in.)	Std. Ctn.
E9812D	1/2	32	10
CE9812D-CTN	1/2	32	10
E9812E	3/4	32	10
CE9812E-CTN	3/4	32	10
E9812F	1	32	10
C9812F	1	32	10

Canada only.

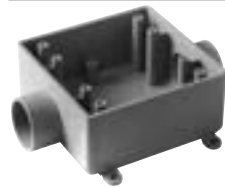

### Features and benefits:

- For dead-end terminations where two devices or additional wiring capacity is required
- All sizes take standard covers and accessories or devices
- Integral mounting feet provide easy mounting

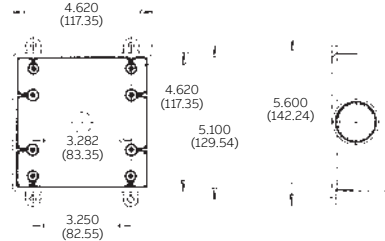

LR31146  
Where noted by



E11461

Type 2FSE

Cat. No.	Size (in.)	Vol. Cu. (in.)	Std. Ctn.
E9802D	1/2	32	10
CE9802D-CTN	1/2	32	10
E9802E	3/4	32	10
CE9802E-CTN	3/4	32	10
E9802F	1	32	10
C9802F	1	32	1

Canada only.



### Features and benefits:

- For terminations where hub requirements vary according to application – hubs easily made with flared wood bit or hole saw
- All sizes take standard covers and accessories or devices
- Integral mounting feet provide easy mounting

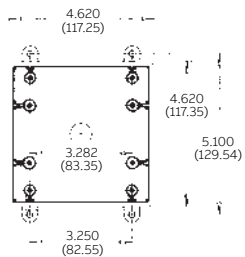

LR31146  
Where noted by



E11461

Type FS

Cat. No.	Size (in.)	Vol. Cu. (in.)	Std. Ctn.
E9802	N/A	32	10
CE9802	N/A	32	10

Canada only.



## Blank covers

For two-gang device boxes

### Features and benefits:

- Fits Carlon® two-gang FS boxes, other non-metallic and metallic FS boxes
- Supplied with stainless steel mounting screws and gasket

Cat. No.	Color	Std. Ctn.	Std. Wt. (lbs.)
E9802CN-CAR	Gray	10	2.17



# Circuit Safe®

## NEMA Enclosures

Circuit Safe® NEMA Enclosures are the flagship product of the Carlon® Enclosure offering. Molded in tough, durable polycarbonate resin, these enclosures lead the market in terms of design, durability, aesthetics and economy of use.

Ranging in size from 6" x 4" x 4" to 16" x 14" x 6", all Circuit Safe® NEMA products are UL 50 Listed and meet Types 4X, 12 and 13. These enclosures utilize recognized materials that carry an ultraviolet rating of F1, ensuring a very long, stable service life when installed outdoors. In addition, the use of polycarbonate material means that these enclosures enjoy an extremely high impact-resistance rating...almost three times more impact resistant than traditional fiberglass enclosures.

Installation of components is made easy, too, with the panel adjuster kits and swing-out panel kits. Subpanels can be stacked or suspended at any depth within the enclosure, maximizing the space available for component mounting. Machining polycarbonate is also safe and easy. There are no splintering problems or airborne fibers as is typical when machining traditional fiberglass products.

Lighter, stronger, easier, safer to use and better looking. Check out Carlon's Circuit Safe® NEMA line today.

### Features and benefits:

- 100% non-metallic construction, including hinges
- Sturdy SS latches install without penetration of the enclosure base
- Clear covers are available, which eliminate the need for window kits
- All cover screws are captive
- Panel suspension system enables the installation of panels at any depth, including stacking of multiple panels
- Swing panels are also available
- Available in junction boxes, external hinge and hidden hinge versions
- Subpanels are available in steel or PVC
- Non-metallic mounting rails for easy installation
- Less than half the weight of metal enclosures, 25% lighter than fiberglass, easier to handle and less expensive to ship
- Full modification services are available

### Applications:

- Any outdoor applications, especially where sunlight resistance is an issue
- Applications where water is present
- Applications where damage during shipment, installation or use is an issue
- Any applications where it is necessary to view internal components through a clear cover
- Applications where weight is an issue
- Applications where the ability to pass wireless signals is needed
- Applications where rust and corrosion are an issue

### Examples:

- Septic and pump controls
- Wireless system component protection
- Marina and sea-side installations
- Controls that require through-cover viewing of readouts and dials
- Machine controls/process controls
- Food and beverage process controls
- Security system controls

### Standards:

- Meets or exceeds NEMA Types 4X, 12 and 13
- Listed per UL 50 as Types 4X, 12 and 13



---

## NEMA enclosure styles

- 01 Screw cover
- 02 External-hinge cover
- 03 Hidden-hinge cover

Circuit Safe® NEMA enclosures are available in three different cover options and a wide range of sizes. From our screw-cover style enclosures to our hidden-hinge cover style enclosures to our external-hinge cover style enclosures, Carlon® has a Circuit Safe® NEMA enclosure to meet your application-specific needs.

**Styles**

- Screw cover
- External hinge
- Hidden hinge

**Cover color options**

- Opaque
- Clear

**Material**

- Polycarbonate (bases and lids)



01



02



03

## Screw-on covers

Meets NEMA 1, 2, 3, 3S, 3X, 3SX, 4, 4X, 12



Opaque cover



Clear cover



### Enclosure Kits

Opaque cover* Cat. No.	Clear cover* Cat. No.	Size (in.)	Back panels**		Std. Ctn.	Std. Wt. (lbs.) Opaque/Clear
			Steel	PVC		
NS644	NV644	6 x 4 x 4	JP64	JP64P	1	Opa 1.8/Clr 1.9
NS664	NV664	6 x 6 x 4	JP66	JP66P	1	Opa 2.4/Clr 2.4
NS864	NV864	8 x 6 x 4	JP86	JP86P	1	Opa 2.9/Clr 2.8
NS884	NV884	8 x 8 x 4	JP88	JP88P	1	Opa 3.2/Clr 3.3
NS1084	NV1084	10 x 8 x 4	JP108	JP108P	1	Opa 4.0/Clr 3.9
NS1086	NV1086	10 x 8 x 6	JP108	JP108P	1	Opa 4.6/Clr 4.5
NS10106	NV10106	10 x 10 x 6	JP1010	JP1010P	1	Opa 5.3/Clr 4.9
NS12106	NV12106	12 x 10 x 6	JP1210	JP1210P	1	Opa 6.1/Clr 5.2
NS12126	NV12126	12 x 12 x 6	JP1212	JP1212P	1	Opa 6.8/Clr 6.1
NS14126	NV14126	14 x 12 x 6	JP1412	JP1412P	1	Opa 7.4/Clr 7.0
NS16146	NV16146	16 x 14 x 6	JP1614	JP1614P	1	Opa 9.2/Clr 8.1

\* Include body, lid and mounting rail kit.

\*\* Order back panels separately.

### Individual Components

Cat. No.	Enclosure Size (in.)	Enclosure Base*		Enclosure Lids		Back Panels**				
		Std. Ctn.	Std. Wt. (lbs.)	Opaque Lids	Clear Lids	Std. Ctn.	Std. Wt. (lbs.)	Steel Cat. No	PVC Cat. No	Std. Ctn.
NP644B	6 x 4 x 4	18	21	NS64L	NV64L	16	Opa 6.4/Clr 5.7	JP64	JP64P	1
NP664B	6 x 6 x 4	12	17	NS66L	NV66L	12	Opa 6.2/Clr 5.7	JP66	JP66P	1
NP864B	8 x 6 x 4	12	18	NS86L	NV86L	9	Opa 6/Clr 4.4	JP86	JP86P	1
NP884B	8 x 8 x 4	14	28	NS88L	NV88L	18	Opa 14/Clr 11.2	JP88	JP88P	1
NP1084B	10 x 8 x 4	12	26	NS108L	NV108L	12	Opa 13/Clr 11	JP108	JP108P	1
NP1086B	10 x 8 x 6	8	23	NS108L	NV108L	12	Opa 13/Clr 11	JP108	JP108P	1
NP1010B	10 x 10 x 6	6	20	NS1010L	NV1010L	11	Opa 14/Clr 12	JP1010	JP1010P	1
NP1210B	12 x 10 x 6	6	23	NS1210L	NV1210L	12	Opa 15/Clr 15	JP1210	JP1210P	1
NP1212B	12 x 12 x 6	5	22	NS1212L	NV1212L	10	Opa 15/Clr 14	JP1212	JP1212P	1
NP1412B	14 x 12 x 6	5	24	NS1412L	NV1412L	5	Opa 9/Clr 9	JP1412	JP1412P	1
NP1614B	16 x 14 x 6	4	31	NS1614L	NV1614L	5	Opa 11/Clr 11	JP1614	JP1614P	1

\* Mounting rails are not included. See "mounting rails" on page ??.

\*\* Order back panels separately.

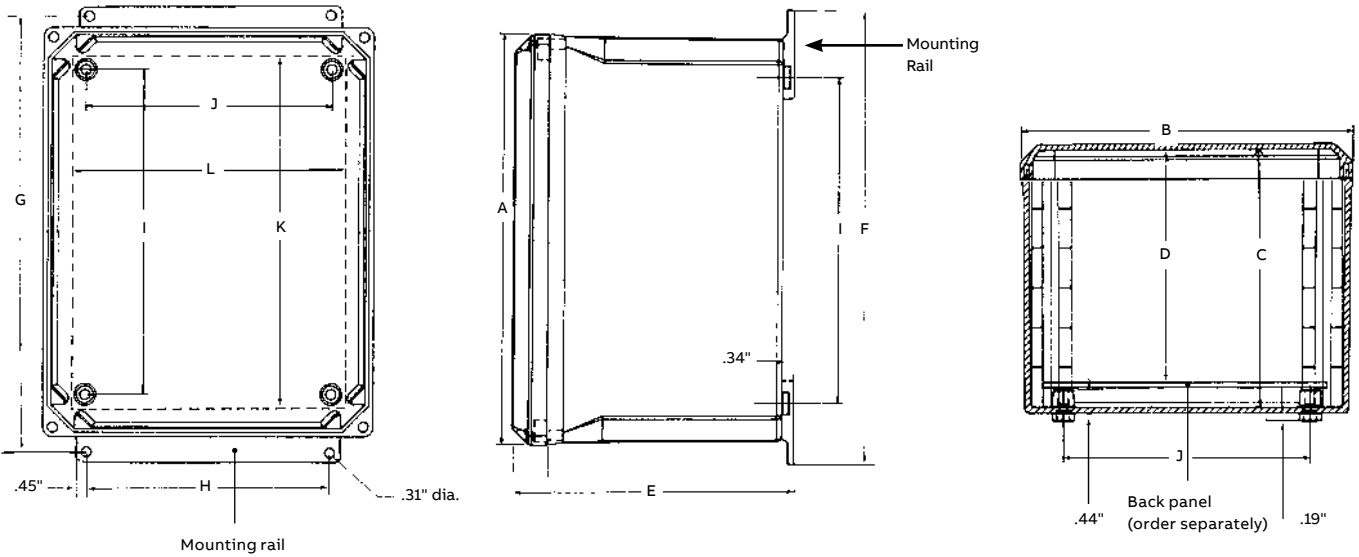
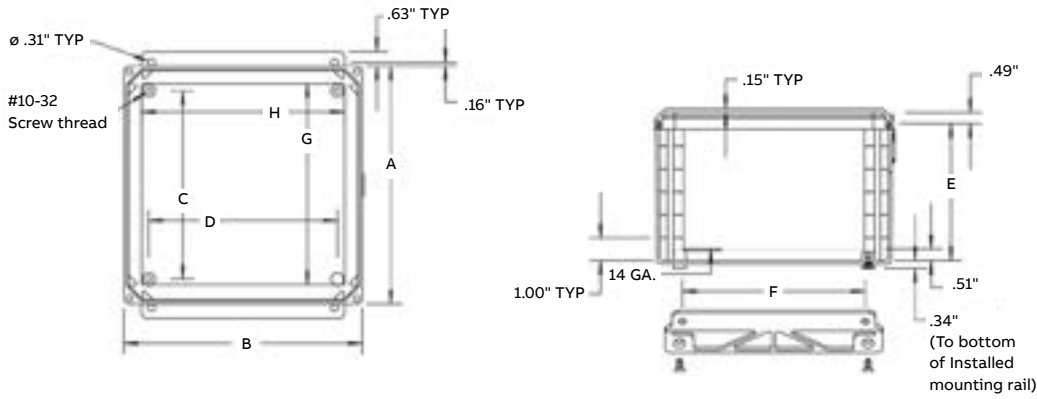

Individual components (continued)

Enclosure with		Enclosure Size (In.)						Enclosure Mounting Hole Spacing		Panel Mounting Hole Spacing		Back Panel Size		Back Panel** Cat. No	
Clear Lid Cat. No	Opaque Lid Cat. No	A	B	C	D	E	F	G	H	I	J	K	L	Steel	PVC
NV644	NS644	6.40	4.40	4.49	3.98	5.13	7.69	6.75	2.00	4.29	2.28	4.88	2.88	JP64	JP64P
NV664	NS664	6.40	6.40	4.49	3.98	5.13	7.69	6.75	4.00	4.28	4.28	4.88	4.88	JP66	JP66P
NV864	NS864	8.40	6.40	4.49	3.98	5.13	9.69	8.75	4.00	6.27	4.26	6.75	4.88	JP86	JP86P
NV884	NS884	8.40	8.40	4.49	3.98	5.13	9.69	8.75	6.00	6.30	6.30	6.75	6.88	JP88	JP88P
NV1084	NS1084	10.40	8.40	4.49	3.98	5.13	11.69	10.75	6.00	8.34	6.30	8.75	6.88	JP108	JP108P
NV1086	NS1086	10.40	8.40	6.49	5.98	7.13	11.69	10.75	6.00	8.34	6.30	8.75	6.88	JP108	JP108P
NV10106	NS10106	10.40	10.40	6.49	5.98	7.13	11.69	10.75	8.00	8.29	8.29	8.75	8.88	JP1010	JP1010P
NV12106	NS12106	12.40	10.40	6.49	5.98	7.13	13.69	12.75	8.00	10.30	8.28	10.75	8.88	JP1210	JP1210P
NV12126	NS12126	12.40	12.40	6.49	5.98	7.13	13.69	12.75	10.00	10.24	10.24	10.75	10.88	JP1212	JP1212P
NV14126	NS14126	14.40	12.40	6.49	5.98	7.13	15.69	14.75	10.00	12.26	10.24	12.75	10.88	JP1412	JP1412P
NV16146	NS16146	16.40	14.40	6.49	5.98	7.13	17.69	16.75	12.00	14.26	12.26	14.75	12.88	JP1614	JP1612P

\* Include body, lid and mounting rail kit.

\*\* Order back panels separately (10/32 - 3/8 back panel screws not supplied).

## Hidden-hinge covers

Meets NEMA 1, 2, 3, 3S, 3X, 3SX, 4, 4X, 12



Opaque cover



Clear cover



### Enclosure kits

Opaque Cover* Cat. No.	Clear Cover* Cat. No.	Size (in.)	Back Panels**		Std. Ctn.	Std. Wt. (lbs.) Opaque/Clear
			Steel	PVC		
NH644	NI644	6 x 4 x 5 †	JP64	JP64P	1	Opa 2.2/Clr 2.8
NH664	NI664	6 x 6 x 5	JP66	JP66P	1	Opa 2.7/Clr 3.2
NH864	NI864	8 x 6 x 5	JP86	JP86P	1	Opa 3.3/Clr 3.8
NH884	NI884	8 x 8 x 5	JP88	JP88P	1	Opa 3.8/Clr 3.8
NH1084	NI1084	10 x 8 x 5	JP108	JP108P	1	Opa 4.0/Clr 4.5
NH1086	NI1086	10 x 8 x 7	JP108	JP108P	1	Opa 5.2/Clr 5.1
NH10106	NI10106	10 x 10 x 7	JP1010	JP1010P	1	Opa 5.7/Clr 5.8
NH12106	NI12106	12 x 10 x 7	JP1210	JP1210P	1	Opa 6.9/Clr 6.1
NH12126	NI12126	12 x 12 x 7	JP1212	JP1212P	1	Opa 7.7/Clr 7.2
NH14126	NI14126	14 x 12 x 7	JP1412	JP1412P	1	Opa 8.3/Clr 7.9
NH16146	NI16146	16 x 14 x 7	JP1614	JP1614P	1	Opa 10.1/Clr 9.6

\* Include body, cover assembly and mounting rail kit.

\*\* Order back panels separately.

† 6 x 4 x 5 size not available with quick-release latches.

### Individual components

Cat. No.	Enclosure Base*			Enclosure Lids		Collars			Back Panels**			Latches				
	Enclosure Size (in.)	Std. Ctn.	Std. Wt. (lbs.)	Opaque Lids Cat. No.	Clear Lids Cat. No.	Std. Ctn.	Std. Wt. (lbs.)	Cat. No.	Std. Ctn.	Std. Wt. (lbs.)	Steel Cat. No.	PVC Cat. No.	Std. Ctn.	Steel Latch Cat. No.	Non-metallic Latch Cat. No.	Std. Ctn.
NP644B	6 x 4 x 5 †	18	21	NH64L	NI64L	16	Opa 6.8/Clr 6.3	NH64C	16	6	JP64	JP64P	1	SSLS	NPLIS	25
NP664B	6 x 4 x 5	12	17	NH66L	NI66L	12	Opa 6.8/Clr 6.3	NH66C	12	5	JP66	JP66P	1	SSLS	NPLIS	25
NP864B	8 x 6 x 5	12	18	NH86L	NI86L	9	Opa 6.3/Clr 5.7	NH86C	9	4	JP86	JP86P	1	SSLS	NPLIS	25
NP884B	8 x 8 x 5	14	28	NH88L	NI88L	18	Opa 16/Clr 15	NH88C	9	3.6	JP88	JP88P	1	SSLS	NPLIS	25
NP1084B	10 x 8 x 5	12	26	NH108L	NI108L	12	Opa 13/Clr 12	NH108C	12	7.8	JP108	JP108P	1	SSLS	NPLIS	25
NP1086B	10 x 8 x 7	8	23	NH108L	NI108L	12	Opa 13/Clr 12	NH108C	12	7.8	JP108	JP108P	1	SSLS	NPLIS	25
NP1010B	10 x 10 x 7	6	20	NH1010L	NI1010L	11	Opa 14/Clr 13	NH1010C	11	7.5	JP1010	JP1010P	1	SSLS	NPLIS	25
NP1210B	12 x 10 x 7 †	6	23	NH1210L	NI1210L	12	Opa 17/Clr 6	NH1210C	12	8	JP1210	JP1210P	1	SSLS	NPLIS	25
NP1212B	12 x 12 x 7 †	5	22	NH1212L	NI1212L	10	Opa 17/Clr 16	NH1212C	12	7.7	JP1212	JP1212P	1	SSLS	NPLIS	25
NP1412B	14 x 12 x 7 †	5	24	NH1412L	NI1412L	5	Opa 10/Clr 10	NH1412C	5	4.7	JP1412	JP1412P	1	SSLS	NPLIS	25
NP1614B	16 x 14 x 7 †	4	31	NH1614L	NI1614L	5	Opa 13/Clr 12	NH1614C	5	5.6	JP1614	JP1614P	1	SSLS	NPLIS	25

\* Mounting rails are not included. See "Mounting Rails" listed on page ??.

\*\* Order back panels separately.

† 6 x 4 x 5 enclosures are not available with quick-release latches.

‡ Sizes 12 x 10 and larger require two (2) latches per enclosure.

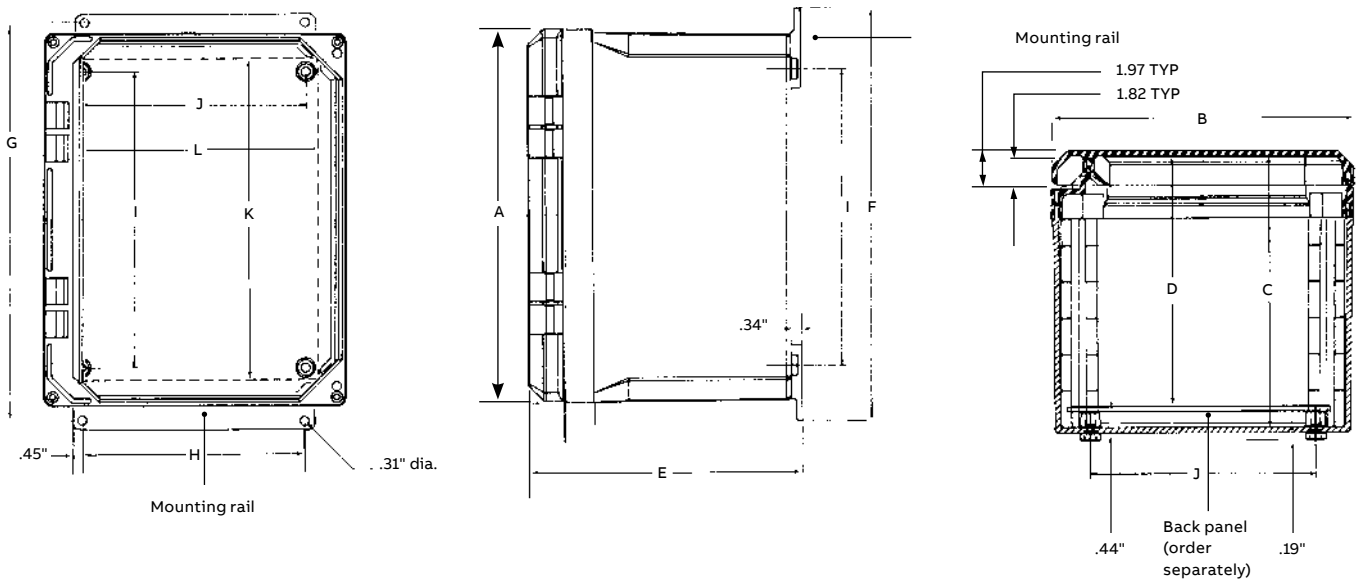

Individual components (continued)

Enclosure With		Enclosure Size (In.)						Enclosure Mounting Hole Spacing		Panel Mounting Hole Spacing		Back Panel Size		Back Panel** Cat. No	
Opaque Lid Cat. No*	Clear Lid Cat. No*	A	B	C	D	E	F	G	H	I	J	K	L	Steel	PVC
NH644	NI644	6.40	4.40	5.30	4.79	5.94	7.69	6.75	2.00	4.29	2.28	4.88	2.88	JP64	JP64P
NH664	NI664	6.40	6.40	5.30	4.79	5.94	7.69	6.75	4.00	4.28	4.28	4.88	4.88	JP66	JP66P
NH864	NI864	8.40	6.40	5.30	4.79	5.94	9.69	8.75	4.00	6.27	4.26	6.75	4.88	JP86	JP86P
NH884	NI884	8.40	8.40	5.30	4.79	5.94	9.69	8.75	6.00	6.30	6.30	6.75	6.88	JP88	JP88P
NH1084	NI1084	10.40	8.40	5.30	4.79	5.94	11.69	10.75	6.00	8.34	6.30	8.75	6.88	JP108	JP108P
NH1086	NI1086	10.40	8.40	7.30	6.79	7.94	11.69	10.75	6.00	8.34	6.30	8.75	6.88	JP108	JP108P
NH10106	NI10106	10.40	10.40	7.30	6.79	7.94	11.59	10.75	8.00	8.29	8.29	8.75	8.88	JP1010	JP1010P
NH12106	NI12106	12.40	10.40	7.30	6.79	7.94	13.69	12.75	8.00	10.30	8.28	10.75	8.88	JP1210	JP1210P
NH12126	NI12126	12.40	12.40	7.30	6.79	7.94	13.69	12.75	10.00	10.24	10.24	10.75	10.88	JP1212	JP1212P
NH14126	NI14126	14.40	12.40	7.30	6.79	7.94	15.69	14.75	10.00	12.26	10.24	12.75	10.88	JP1412	JP1412P
NH16146	NI16146	16.40	14.40	7.30	6.79	7.94	17.69	16.75	12.00	14.26	12.26	14.75	12.88	JP1614	JP1612P

\* Include body, lid and mounting rail kit.

\*\* Order back panels separately (10/32 - 3/8 Back Panel screws not supplied).

## External-hinge covers

Meets NEMA 1, 2, 3, 3S, 3X, 3SX, 4, 4X, 12



Opaque cover



Clear cover



### Enclosure kits

Opaque Cover* Cat. No.	Clear Cover* Cat. No.	Back Panels** Steel	Back Panels** PVC	Size (in.)	Std. Ctn.	Std. Wt. (lbs.) Opaque/Clear
NJ664	NC664	JP66	JP66P	6 x 6 x 4	1	Opa 2.4/Clr 2.4
NJ864	NC864	JP86	JP86P	8 x 6 x 4	1	Opa 2.9/Clr 2.9
NJ884	NC884	JP88	JP88P	8 x 8 x 4	1	Opa 3.3/Clr 3.3
NJ1084	NC1084	JP108	JP108P	10 x 8 x 4	1	Opa 4/Clr 4
NJ1086	NC1086	JP108	JP108P	10 x 8 x 6	1	Opa 4.6/Clr 4.7
NJ10106	NC10106	JP1010	JP1010P	10 x 10 x 6	1	Opa 5.6/Clr 5.3
NJ12106	NC12106	JP1210	JP1210P	12 x 10 x 6	1	Opa 6.3/Clr 5.8
NJ12126	NC12126	JP1212	JP1212P	12 x 12 x 6	1	Opa 6.9/Clr 6.6
NJ14126	NC14126	JP1412	JP1412P	14 x 12 x 6	1	Opa 7.7/Clr 7
NJ16146	NC16146	JP1614	JP1614P	16 x 14 x 6	1	Opa 8.2/Clr 8

\* Include body, lid and mounting rail kit.

\*\* Order back panels separately.

### Individual components

Cat. No.	Enclosure Base*			Enclosure Lids		Enclosure Lids		Back Panels**		Back Panels**		Latches	
	Enclosure Size (in.)	Std. Ctn.	Std. Wt. (lbs.)	Opaque Lids Cat. No.	Clear Lids Cat. No.	Std. Ctn.	Std. Wt. (lbs.)	Steel Cat. No	PVC Cat. No	Std. Ctn.	Steel Latch Cat. No	Non-metallic Latch Cat. No	Std. Ctn.
NL664B	6 x 6 x 4	12	18	NJ66L	NC66L	12	Opa 5.0/Clr 5.9	JP66	JP66P	1	SSLS	NPLIS	25
NL864B	8 x 6 x 4	8	14	NJ86L	NC86L	9	Opa 6/Clr 5.3	JP86	JP86P	1	SSLS	NPLIS	25
NL884B	8 x 8 x 4	14	28	NJ88L	NC88L	18	Opa 15/Clr 13.5	JP88	JP88P	1	SSLS	NPLIS	25
NL1084B	10 x 8 x 4	12	32	NJ108L	NC108L	12	Opa 13/Clr 11.7	JP108	JP108P	1	SSLS	NPLIS	25
NL1086B	10 x 8 x 6	8	15	NJ108L	NC108L	12	Opa 13/Clr 11.7	JP108	JP108P	1	SSLS	NPLIS	25
NL1010B	10 x 10 x 6	6	20	NJ1010L	NC1010L	11	Opa 14/Clr 13	JP1010	JP1010P	1	SSLS	NPLIS	25
NL1210B	12 x 10 x 6 †	6	24	NJ1210L	NC1210L	12	Opa 14/Clr 15	JP1210	JP1210P	1	SSLS	NPLIS	25
NL1212B	12 x 12 x 6 †	5	21.8	NJ1212L	NC1212L	10	Opa 16/Clr 14	JP1212	JP1212P	1	SSLS	NPLIS	25
NL1412B	14 x 12 x 6 †	4	19	NJ1412L	NC1412L	5	Opa 10/Clr 9	JP1412	JP1412P	1	SSLS	NPLIS	25
NL1614B	16 x 14 x 6 †	4	31	NJ1614L	NC1614L	5	Opa 13.5/Clr 12	JP1614	JP1614P	1	SSLS	NPLIS	25

\* Mounting rails are not included. See mounting rails on page ??.

\*\* Order back panels separately.

† Sizes 12 x 10 and larger require two (2) latches per enclosure.

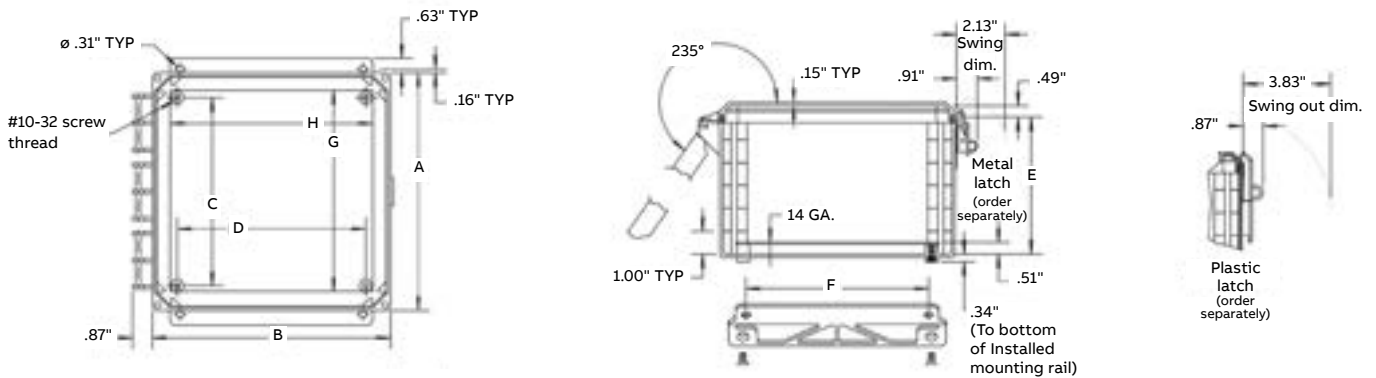

Individual components (continued)

Enclosure With		Enclosure Size (In.)						Enclosure Mounting Hole Spacing		Panel Mounting Hole Spacing		Back Panel Size		Back Panel** Cat. No	
Clear Lid Cat. No*	Opaque Lid Cat. No*	A	B	C	D	E	F	G	H	I	J	K	L	Steel	PVC
NC644	NJ644	6.40	4.40	4.49	3.98	5.13	7.69	6.75	2.00	4.29	2.28	4.88	2.88	JP64	JP64P
NC664	NJ664	6.40	6.40	4.49	3.98	5.13	7.69	6.75	4.00	4.28	4.28	4.88	4.88	JP66	JP66P
NC864	NJ864	8.40	6.40	4.49	3.98	5.13	9.69	8.75	4.00	6.27	4.26	6.75	4.88	JP86	JP86P
NC884	NJ884	8.40	8.40	4.49	3.98	5.13	9.69	8.75	6.00	6.30	6.30	6.75	6.88	JP88	JP88P
NC1084	NJ1084	10.40	8.40	4.49	3.98	5.13	11.69	10.75	6.00	8.34	6.30	8.75	6.88	JP108	JP108P
NC1086	NJ1086	10.40	8.40	6.49	5.98	7.13	11.69	10.75	6.00	8.34	6.30	8.75	6.88	JP108	JP108P
NC10106	NJ10106	10.40	10.40	6.49	5.98	7.13	11.69	10.75	8.00	8.29	8.29	8.75	8.88	JP1010	JP1010P
NC12106	NJ12106	12.40	10.40	6.49	5.98	7.13	13.69	12.75	8.00	10.30	8.28	10.75	8.88	JP1210	JP1210P
NC12126	NJ12126	12.40	12.40	6.49	5.98	7.13	13.69	12.75	10.00	10.24	10.24	10.75	10.88	JP1212	JP1212P
NC14126	NJ14126	14.40	12.40	6.49	5.98	7.13	15.69	14.75	10.00	12.26	10.24	12.75	10.88	JP1412	JP1412P
NC16146	NJ16146	16.40	14.40	6.49	5.98	7.13	17.69	16.75	12.00	14.26	12.26	14.75	12.88	JP1614	JP1614P

\* Include body, lid and mounting rail kit.

\*\* Order back panels separately (10/32 - 3/8 Back Panel screws not supplied).

# Quick Reference

## Screw-on cover styles

Enclosure Kits (no panel or latches)							Individual components	
Opaque Lid	Clear Lid	Body	Lid	Collar	Mtg. Rails	Back Panels		
						Steel	PVC	
NS644		NP644B	NS64L	N/A	NMK4V	JP64	JP64P	
	NV644	NP644B	NV64L	N/A	NMK4V	JP64	JP64P	
NS664		NP664B	NS66L	N/A	NMK6V	JP66	JP66P	
	NV664	NP664B	NV66L	N/A	NMK6V	JP66	JP66P	
NS864		NP864B	NS86L	N/A	NMK6V	JP86	JP86P	
	NV864	NP864B	NV86L	N/A	NMK6V	JP86	JP86P	
NS884		NP884B	NS88L	N/A	NMK8V	JP88	JP88P	
	NV884	NP884B	NV88L	N/A	NMK8V	JP88	JP88P	
NS1084		NP1084B	NS108L	N/A	NMK8V	JP108	JP108P	
	NV1084	NP1084B	NV108L	N/A	NMK8V	JP108	JP108P	
NS1086		NP1086B	NS108L	N/A	NMK8V	JP108	JP108P	
	NV1086	NP1086B	NV108L	N/A	NMK8V	JP108	JP108P	
NS10106		NP1010B	NS1010L	N/A	NMK10V	JP1010	JP1010P	
	NV10106	NP1010B	NV1010L	N/A	NMK10V	JP1010	JP1010P	
NS12106		NP1210B	NS1210L	N/A	NMK10V	JP1210	JP1210P	
	NV12106	NP1210B	NV1210L	N/A	NMK10V	JP1210	JP1210P	
NS12126		NP1212B	NS1212L	N/A	NMK12V	JP1212	JP1212P	
	NV12126	NP1212B	NV1212L	N/A	NMK12V	JP1212	JP1212P	
NS14126		NP1412B	NS1412L	N/A	NMK12V	JP1412	JP1412P	
	NV14126	NP1412B	NV1412L	N/A	NMK12V	JP1412	JP1412P	
NS16146		NP1614B	NS1614L	N/A	NMK14V	JP1614	JP1614P	
	NV16146	NP1614B	NV1614L	N/A	NMK14V	JP1614	JP1614P	

## External-hinge cover styles

Enclosure kits (no panel or latches)							Individual components			
Opaque lid	Clear lid	Body	Lid	Collar	Mtg. Rails	Back Panels		Latches (Qty. needed)		
						Steel	PVC	Steel	Non-metallic	
NJ644		NL644B	NJ64L	N/A	NMK4V	JP64	JP64P	SSLS (1)	NPL1S (1)	
	NC644	NL644B	NC64L	N/A	NMK4V	JP64	JP64P	SSLS (1)	NPL1S (1)	
NJ664		NL664B	NJ66L	N/A	NMK6V	JP66	JP66P	SSLS (1)	NPL1S (1)	
	NC664	NL664B	NC66L	N/A	NMK6V	JP66	JP66P	SSLS (1)	NPL1S (1)	
NJ864		NL864B	NJ86L	N/A	NMK6V	JP86	JP86P	SSLS (1)	NPL1S (1)	
	NC864	NL864B	NC86L	N/A	NMK6V	JP86	JP86P	SSLS (1)	NPL1S (1)	
NJ884		NL884B	NJ88L	N/A	NMK8V	JP88	JP88P	SSLS (1)	NPL1S (1)	
	NC884	NL884B	NC88L	N/A	NMK8V	JP88	JP88P	SSLS (1)	NPL1S (1)	
NJ1084		NL1084B	NJ108L	N/A	NMK8V	JP108	JP108P	SSLS (1)	NPL1S (1)	
	NC1084	NL1084B	NC108L	N/A	NMK8V	JP108	JP108P	SSLS (1)	NPL1S (1)	
NJ1086		NL1086B	NJ108L	N/A	NMK8V	JP108	JP108P	SSLS (1)	NPL1S (1)	
	NC1086	NL1086B	NC108L	N/A	NMK8V	JP108	JP108P	SSLS (1)	NPL1S (1)	
NJ10106		NL1010B	NJ1010L	N/A	NMK10V	JP1010	JP1010P	SSLS (1)	NPL1S (1)	
	NC10106	NL1010B	NC1010L	N/A	NMK10V	JP1010	JP1010P	SSLS (1)	NPL1S (1)	
NJ12106		NL1210B	NJ1210L	N/A	NMK10V	JP1210	JP1210P	SSLS (2)	NPL1S (2)	
	NC12106	NL1210B	NC1210L	N/A	NMK10V	JP1210	JP1210P	SSLS (2)	NPL1S (2)	
NJ12126		NL1212B	NJ1212L	N/A	NMK12V	JP1212	JP1212P	SSLS (2)	NPL1S (2)	
	NC12126	NL1212B	NC1212L	N/A	NMK12V	JP1212	JP1212P	SSLS (2)	NPL1S (2)	
NJ14126		NL1412B	NJ1412L	N/A	NMK12V	JP1412	JP1412P	SSLS (2)	NPL1S (2)	
	NC14126	NL1412B	NC1412L	N/A	NMK12V	JP1412	JP1412P	SSLS (2)	NPL1S (2)	
NJ16146		NL1614B	NJ1614L	N/A	NMK14V	JP1614	JP1614P	SSLS (2)	NPL1S (2)	
	NC16146	NL1614B	NC1614L	N/A	NMK14V	JP1614	JP1614P	SSLS (2)	NPL1S (2)	

Hidden-hinge cover styles

Enclosure kits (no panel or latches)								Individual components	
Opaque Lid	Clear Lid	Body	Lid	Collar	Mtg. Rails	Back Panels		Latches (Qty. needed)	
						Steel	PVC	Steel	Non-metallic
NH644		NP644B	NH64L	NH64C	NMK4V	JP64	JP64P	SSLL (1)	NPL1L (1)
	NI644	NP644B	NI64L	NH64C	NMK4V	JP64	JP64P	SSLL (1)	NPL1L (1)
NH664		NP664B	NH66L	NH66C	NMK6V	JP66	JP66P	SSLL (1)	NPL1L (1)
	NI664	NP664B	NI66L	NH66C	NMK6V	JP66	JP66P	SSLL (1)	NPL1L (1)
NH864		NP864B	NH86L	NH86C	NMK6V	JP86	JP86P	SSLL (1)	NPL1L (1)
	NI864	NP864B	NI86L	NH86C	NMK6V	JP86	JP86P	SSLL (1)	NPL1L (1)
NH884		NP884B	NH88L	NH88C	NMK8V	JP88	JP88P	SSLL (1)	NPL1L (1)
	NI884	NP884B	NI88L	NH88C	NMK8V	JP88	JP88P	SSLL (1)	NPL1L (1)
NH1084		NP1084B	NH108L	NH108C	NMK8V	JP108	JP108P	SSLL (1)	NPL1L (1)
	NI1084	NP1084B	NI108L	NH108C	NMK8V	JP108	JP108P	SSLL (1)	NPL1L (1)
NH1086		NP1086B	NH108L	NH108C	NMK8V	JP108	JP108P	SSLL (1)	NPL1L (1)
	NI1086	NP1086B	NI108L	NH108C	NMK8V	JP108	JP108P	SSLL (1)	NPL1L (1)
NH10106		NP1010B	NH1010L	NH1010C	NMK10V	JP1010	JP1010P	SSLL (1)	NPL1L (1)
	NI10106	NP1010B	NI1010L	NH1010C	NMK10V	JP1010	JP1010P	SSLL (1)	NPL1L (1)
NH12106		NP1210B	NH1210L	NH1210C	NMK10V	JP1210	JP1210P	SSLL (2)	NPL1L (2)
	NI12106	NP1210B	NI1210L	NH1210C	NMK10V	JP1210	JP1210P	SSLL (2)	NPL1L (2)
NH12126		NP1212B	NH1212L	NH1212C	NMK12V	JP1212	JP1212P	SSLL (2)	NPL1L (2)
	NI12126	NP1212B	NI1212L	NH1212C	NMK12V	JP1212	JP1212P	SSLL (2)	NPL1L (2)
NH14126		NP1412B	NH1412L	NH1412C	NMK12V	JP1412	JP1412P	SSLL (2)	NPL1L (2)
	NI14126	NP1412B	NI1412L	NH1412C	NMK12V	JP1412	JP1412P	SSLL (2)	NPL1L (2)
NH16146		NP1614B	NH1614L	NH1614C	NMK14V	JP1614	JP1614P	SSLL (2)	NPL1L (2)
	NI16146	NP1614B	NI1614L	NH1614C	NMK14V	JP1614	JP1614P	SSLL (2)	NPL1L (2)

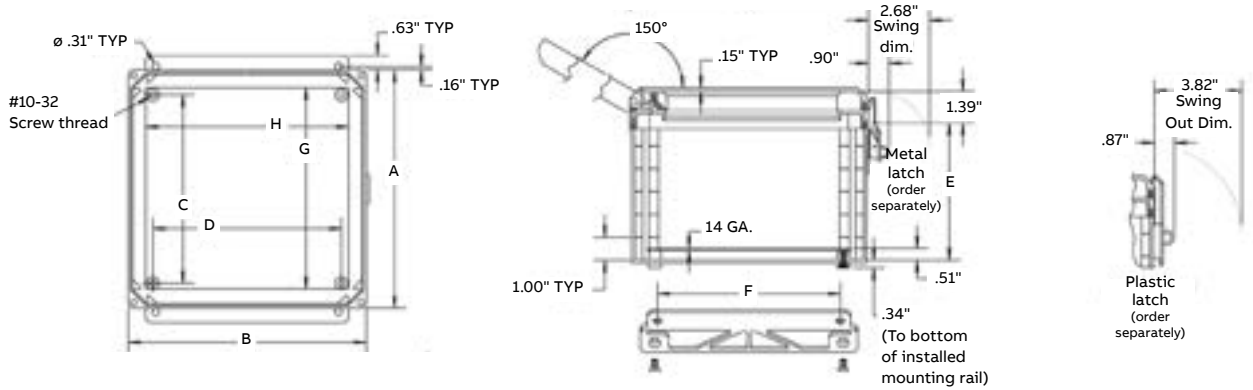

# Circuit Safe®

## JIC enclosures

Manufactured from structural foam thermoplastic, Carlon® Circuit Safe® JIC enclosures provide high-impact strength to eliminate dents and deformations along with high dielectric strength, excellent weathering capabilities and excellent resistance to a wide range of corrosive agents, acids, alkalines and salts.

These UL Approved and CSA Recognized enclosures also withstand wet and dirty environments, while their thick-wall construction make them a particularly good choice wherever condensation is a concern. Rated for use in Type 1, 3, 3S, 3X, 3SX, 4, 4X, 12 and 13 environments, Carlon® Circuit Safe® JIC enclosures are suited for virtually all indoor/outdoor industrial, MRO and OEM applications.

They are available in 10 sizes from 6 x 6 x 5 through 30 x 24 x 12 with a choice of screw or hinged design, opaque covers or clear polycarbonate covers that protect devices from hostile environments while enabling monitoring of instrumentation and/or electrical functions.

### Features and benefits:

- Hinge caps make covers captive
- Non-metallic molded-in hinges on hinged models
- No rough corners, sharp edges or burrs
- Non-conductive – eliminates danger of electrical shock
- Lid design provides greater usable internal volume
- Ample interior space for ease of wiring
- Fully gasketed
- Ultraviolet stabilized for outdoor use

### Applications:

- Instrument case
- Junction and terminal boxes
- Control and switching enclosures
- Splice and pull boxes
- Starter, pushbutton and transformer housings
- Meter and transformer cabinets

### Standards:

- Meets NEMA Types 1, 3, 3S, 3X, 3SX, 4, 4X, 12, 13 as indicated
- UL® Listed per UL 50, enclosures for electrical equipment
- CSA Certified
- JIC compliance



## Hinged covers

Meets NEMA 1, 3, 3S, 3X, 3SX, 4, 4X, 12, 13

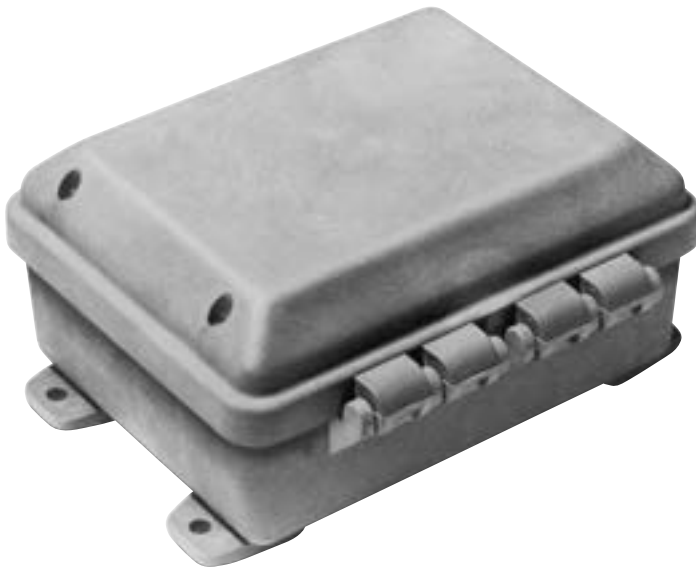

### Features and benefits:

- Non-metallic mounting feet and all mounting hardware included
- White-painted 14-gauge steel or ¼" PVC back panel (order separately)
- 304 (18-8) stainless steel screws (10-32/1½")
- Lid design provides greater usable internal volume
- Completely non-metallic hinges
- Brass screw inserts
- Temperature range: -30° to 230°F
- Material: polycarbonate molded base and cover



Factory assembled

Opaque Cover Cat. No.	Clear Cover Cat. No.	Dimensions (in.)								Std. Wt. (lbs.) Opaque/Clear	Back Panel* Cat. No.		Panel Size (in.)	Std. Wt. (lbs.) Steel/PVC
		External			Internal			Mounting			Steel	PVC		
		A	B	C	D	E	F	G	H					
CJ665	CC665	6.50	6.50	6.69	6.00	6.00	5.45	9.00	4.00	1 (Opa 3.5)/ 1 (Clr 3.1)	JP66	JP66P	4.88 x 4.88	1 (1.0)/1 (0.3)
CJ863	CC863	8.50	6.50	4.49	8.00	6.00	3.25	11.00	4.00	1 (Opa 2.8)/ 1 (Clr 3.1)	JP86	JP86P	6.75 x 4.88	1 (1.0)/1 (0.78)
CJ1085	CC1085	10.50	8.50	6.69	10.00	8.00	5.45	13.00	6.00	1 (Opa 5.2)/ 1 (Clr 5.2)	JP108	JP108P	8.75 x 6.88	1 (1.5)/1 (0.7)
CJ12106	CC12106	12.50	10.50	7.69	12.00	10.00	6.45	15.00	8.00	1 (Opa 7.1)/ 1 (Clr 8.4)	JP1210	JP1210P	10.75 x 8.88	1 (2.0)/1 (1.2)
CJ14126	CC14126	14.50	12.50	7.72	14.00	12.00	6.48	17.00	10.00	1 (Opa 9.0)/ 1 (Clr 8.6)	JP1412	JP1412P	12.75 x 10.88	1 (3.2)/1 (1.7)
CJ16147	CC16147	16.50	14.50	8.46	16.00	14.00	7.22	19.00	12.00	1 (Opa 10.6)/ 1 (Clr 11.9)	JP1614	JP1614P	14.75 x 12.88	1 (4.7)/1 (2.3)

\*Order back panels separately.  
Enclosures shipped with mounting feet, hinge caps and screws.  
For factory-installed pad-lockable latch (part no. CJTL), consult customer service for price and delivery.

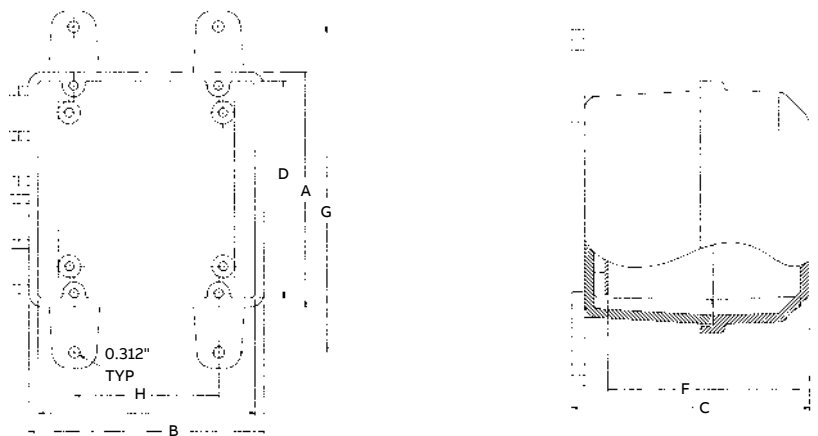

## Screw-on covers

Meets NEMA 1, 3, 3S, 3X, 3SX, 4, 4X, 12, 13



### Features and benefits:

- Non-metallic mounting feet and all mounting hardware included
- 304 (18-8) stainless steel screws (10-32/1½")
- Brass screw inserts
- Clear polycarbonate cover available
- White-painted 14-gauge steel or ¼" PVC back panel (order separately)
- Lid design provides greater usable internal volume
- Temperature range: -30° to 230°F
- Material: polycarbonate molded base and cover



Factory assembled

Opaque Cover Cat. No.	Clear Cover Cat. No.	Dimensions (in.)								Std. Wt. (lbs.) Opaque/Clear	Back Panel* Cat. No.		Panel Size (in.)	Std. Wt. (lbs.) Steel/PVC
		External			Internal			Mounting			Steel	PVC		
		A	B	C	D	E	F	G	H					
CS665	CV665	6.50	6.50	6.69	6.00	6.00	5.45	9.00	4.00	1 (Opa 2.7)/1 (Clr 2.9)	JP66	JP66P	4.88 x 4.88	1 (1.0)/1 (0.3)
CS863	CV863	8.50	6.50	4.49	8.00	6.00	3.25	11.00	4.00	1 (Opa 2.9)/1 (Clr 2.9)	JP86	JP86P	6.75 x 4.88	1 (1.0)/1 (0.4)
CS1085	CV1085	10.50	8.50	6.69	10.00	8.00	5.45	13.00	6.00	1 (Opa 5.0)/1 (Clr 5.0)	JP108	JP108P	8.75 x 6.88	1 (1.5)/1 (0.7)
CS12106	CV12106	12.50	10.50	7.69	12.00	10.00	6.45	15.00	8.00	1 (Opa 6.5)/1 (Clr 7.2)	JP1210	JP1210P	10.75 x 8.88	1 (2.0)/1 (1.2)
CS14126	CV14126	14.50	12.50	7.72	14.00	12.00	6.48	17.00	10.00	1 (Opa 8.0)/1 (Clr 8.8)	JP1412	JP1412P	12.75 x 10.88	1 (3.2)/1 (1.7)
CS16147	CV16147	16.50	14.50	8.46	16.00	14.00	7.22	19.00	12.00	1 (Opa 11.5)/1 (Clr 10.8)	JP1614	JP1614P	14.75 x 12.88	1 (4.7)/1 (2.3)

\*Order back panels separately.  
Enclosures shipped with mounting feet and panel mounting hardware.

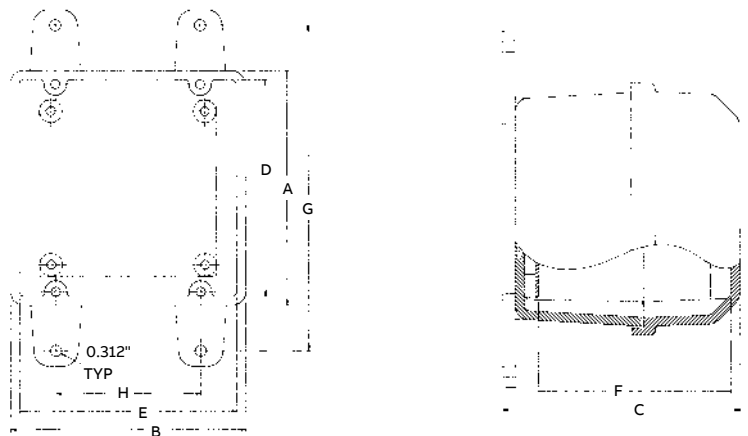

## Medium hinged covers

Meets NEMA 1, 3, 3S, 3X, 3SX, 4, 4X, 12, 13



### Features and benefits:

- Non-metallic mounting feet and all mounting hardware included
- White-painted 14-gauge steel or ¼" PVC back panel (order separately)
- 304 (18-8) stainless steel screws (10-32/1½")
- Completely non-metallic hinges
- Brass screw inserts
- Temperature range: -40° to 185°F
- Material: NORYL base and cover

Factory assembled



Cat. No.	Dimensions (in.)								Std. Wt. (lbs.)	Back Panel* Cat. No.		Panel Size (in.)	Std. Wt. (lbs.) Steel/PVC
	External			Internal			Mounting			Steel	PVC		
	A	B	C	D	E	F	G	H					
C2016A4	20.50	16.50	8.36	17.25	13.25	6.28	21.26	10.00	1 (15.1)	NP2016	NP2016P	17 x 13.25	1 (7.0)/1 (6.1)
C2016B4	20.50	16.50	10.36	17.25	13.25	8.28	21.26	10.00	1 (17.2)	NP2016	NP2016P	17 x 13.25	1 (7.0)/1 (6.1)
C2016C4	20.50	16.50	12.36	17.25	13.25	10.28	21.26	10.00	1 (19.7)	NP2016	NP2016P	17 x 13.25	1 (7.0)/1 (6.1)
C2420A4	24.50	20.50	8.36	21.25	17.25	6.28	25.26	14.00	1 (21.5)	NP2420	NP2420P	21 x 17	1 (10.4)/1 (4.7)
C2420B4	24.50	20.50	10.36	21.25	17.25	8.28	25.26	14.00	1 (24)	NP2420	NP2420P	21 x 17	1 (10.4)/1 (4.7)
C2420C4	24.50	20.50	12.36	21.25	17.25	10.28	25.26	14.00	1 (24.9)	NP2420	NP2420P	21 x 17	1 (10.4)/1 (4.7)
C3024A4	30.50	24.50	8.36	27.25	21.25	6.28	31.26	18.00	1 (28.4)	NP3024	NP3024P	27 x 21	1 (18.0)/1 (9.8)
C3024B4	30.50	24.50	10.36	27.25	21.25	8.28	31.26	18.00	1 (31.4)	NP3024	NP3024P	27 x 21	1 (18.0)/1 (9.8)
C3024C4	30.50	24.50	12.36	27.25	21.25	10.28	31.26	18.00	1 (33.8)	NP3024	NP3024P	27 x 21	1 (18.0)/1 (9.8)

\*Order back panels separately.

\*Enclosure only available with opaque hinged cover.

Enclosures shipped with mounting feet, hinge caps and screws.

For factory-installed pad-lockable latch (part no. CJTL), consult customer service for price and delivery.

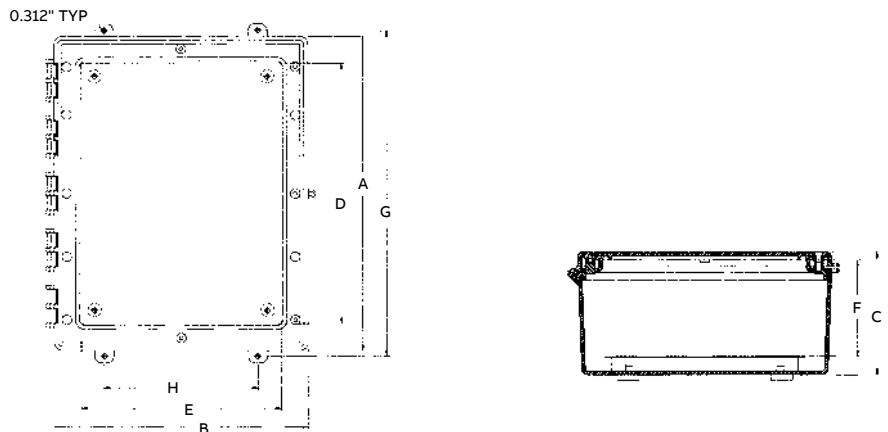

## Hinged window cover

Meets NEMA 1, 3, 3S, 3X, 3SX, 4, 4X, 12, 13



### Features and benefits:

- Non-metallic mounting feet and all mounting hardware included
- 304 (18-8) stainless steel screws (10-32/1½")
- White-painted 14-gauge steel or ¼" PVC back panel (order separately)
- Completely non-metallic hinges
- Lid design provides greater usable internal volume
- Brass screw inserts
- Material: polycarbonate molded base and cover

Note: Window material ⅛" thick, clear polycarbonate is permanently bonded to the cover.



Factory assembled

Cat. No.	Dimensions (in.)										Std. Wt. (lbs.)	Back Panel*		Panel Size (in.)	Std. Wt. (lbs.) Steel/PVC
	External				Internal			Mounting				Steel	PVC		
	A	B	C	D	E	F	G	H	J	K					
J665W	6.50	6.50	6.69	6.00	6.00	5.45	9.00	4.00	3.75	3.75	1 (3.1)	JP66	JP66P	4.88 x 4.88	1 (1.0)/1 (0.3)
J863W	8.50	6.50	4.49	8.00	6.00	3.25	11.00	4.00	3.75	3.75	1 (3.2)	JP86	JP86P	6.75 x 4.88	1 (1.0)/1 (0.78)
J1085W	10.50	8.50	6.69	10.00	8.00	5.45	13.00	6.00	7.75	5.75	1 (5.6)	JP108	JP108P	8.75 x 6.88	1 (1.5)/1 (0.7)
J12106W	12.50	10.50	7.69	12.00	10.00	6.45	15.00	8.00	9.75	7.75	1 (7.4)	JP1210	JP1210P	10.75 x 8.88	1 (2.0)/1 (1.2)

Enclosures shipped with mounting feet, hinge caps and screws.

\*Order back panels separately.

For factory-installed pad-lockable quick-release latch (part no. CJTL), consult customer service for price and delivery.

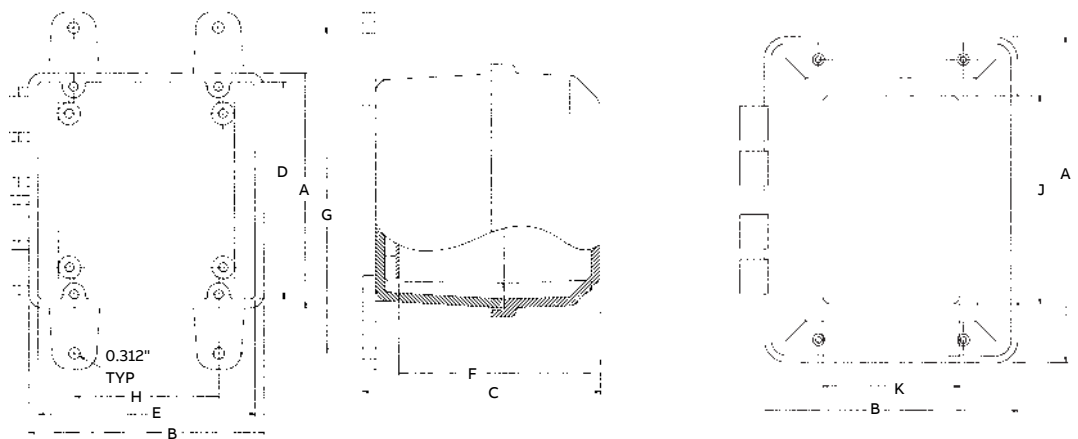

# Circuit Safe®

## Pushbutton enclosures

Circuit Safe® non-metallic pushbutton enclosures are molded from engineered thermoplastic material that is resistant to most corrosive agents. Whether predrilled 1-2-3 hole enclosures, blank cover enclosures or enclosures with multiple hole openings, Carlon's pushbutton enclosure series offers high-impact strength, chemical resistance, high dielectric strength and excellent durability for the correct application.

### Features and benefits:

- Engineered thermoplastic base and cover
- 304 stainless steel screws
- Brass screw inserts
- High-impact strength
- Temperature range: -40° to 185°F
- UL94-V2

### Applications:

- Standard oil-tight pushbuttons, switches and pilot lights
- Conduit entries
- Junction boxes
- MRO and OEM applications

### Standards:

- Standards vary by product
- Screw cover pushbutton enclosures with 1-2-3 hole openings are listed per UL 50 for industrial controls
- Narrow-profile blank-screw cover enclosures are listed per UL 50 for industrial controls and meet NEMA Type 1, 3, 3S, 3X, 3SX, 4, 4X, 12 and 13
- Non-metallic hinged cover enclosures with multiple hole openings are UL Listed

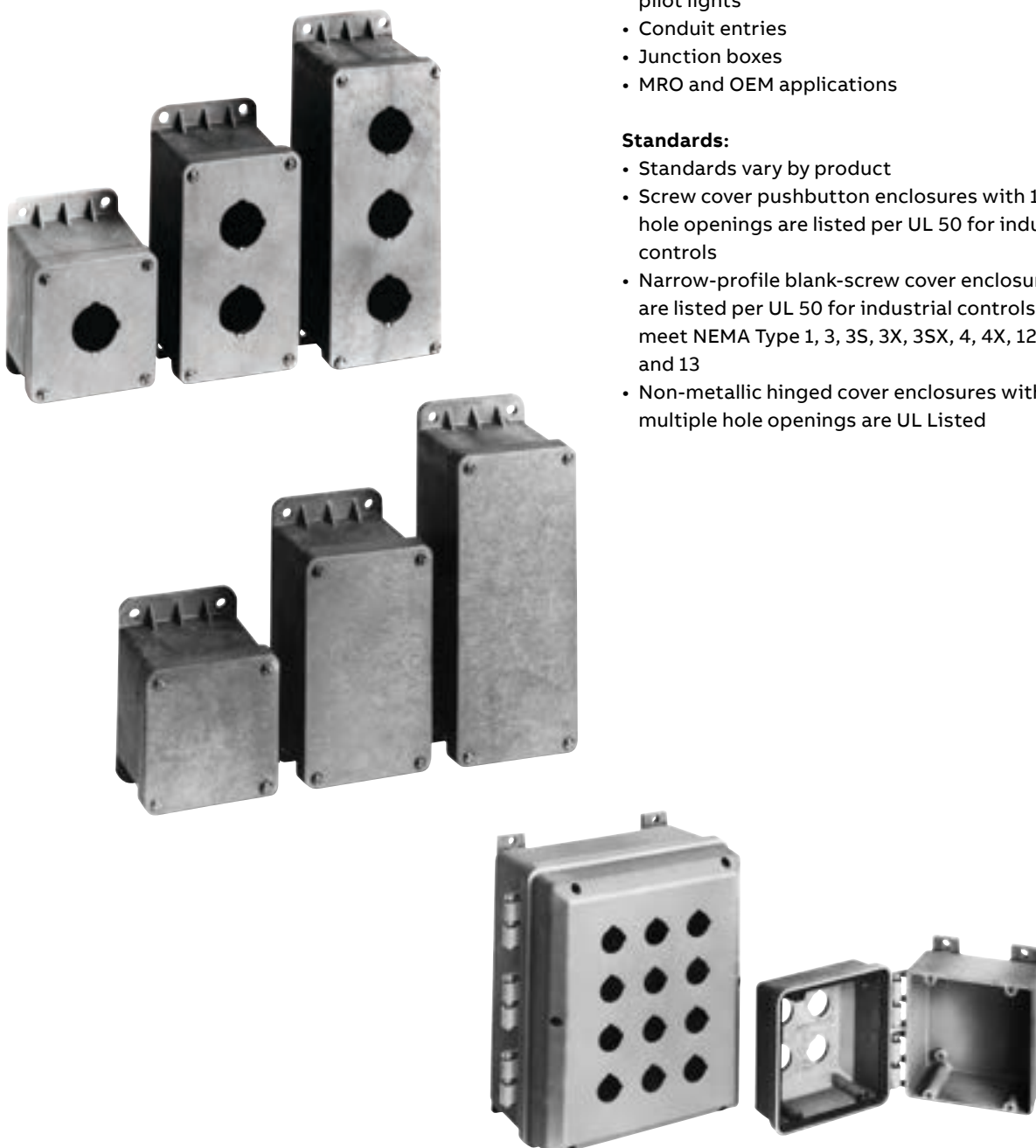

## Screw cover enclosures with 1-2-3 hole openings

UL® Listed per UL 50 for industrial controls

Wallmount pushbutton enclosures are molded from gray, engineered thermoplastic material that is resistant to most corrosive agents. Universal pushbutton holes are designed to accommodate all standard oil-tight pushbuttons, switches and pilot lights. A grounding plate is included on the cover. Auxiliary devices must be rated for appropriate NEMA applications.

### Features and benefits:

- 30.5mm keyed pushbutton holes\*
- Material: nylon base and cover
- Integrally molded mounting flange
- Brass screw inserts
- 304 (18-8) stainless screws (8-32/3/16")
- Temperature range: -40° to 185°F
- UL94-V2

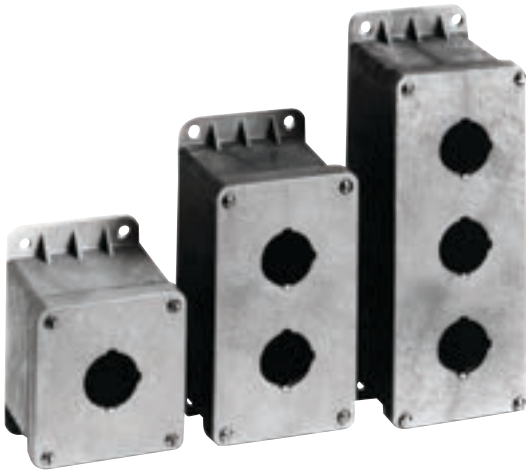

30.5mm pushbutton enclosures†

Cat. No.	Style	Inside box size A x B x C	Mounting L x J	Overall outside including mounting bracket H x W x D				F	G	R	S	Std. Ctn.	Std. Wt. (lbs.)
				H	W	D							
CP100N	One Opening	3.13 x 2.81 x 3	4 x 2.38	4.88	3.50	3.38	3.38	3.25	.63	2.5	12	9	
CP200N	Two Openings	5.38 x 2.81 x 3	6.25 x 2.38	7.13	3.50	3.38	5.63	3.25	.63	2.5	8	8	
CP300N	Three Openings	7.38 x 2.81 x 3	8.50 x 2.38	9.38	3.50	3.38	7.88	3.25	.63	2.5	6	7.60	

22mm pushbutton enclosures\*†

Cat. No.	Style	Inside box size A x B x C	Mounting L x J	Overall outside including mounting bracket H x W x D				F	G	R	S	Std. Ctn.	Std. Wt. (lbs.)
				H	W	D							
PX0010	One Opening	3.13 x 2.81 x 3	4 x 2.38	4.88	3.50	3.38	3.38	3.25	.63	2.5	10	8.26	
PX0007	Two Openings	5.38 x 2.81 x 3	6.25 x 2.38	7.13	3.50	3.38	5.63	3.25	.63	2.5	1	1.31	
PX0011	Three Openings	7.38 x 2.81 x 3	8.50 x 2.38	9.38	3.50	3.38	7.88	3.25	.63	2.5	6	9.43	
PX0008	Four Openings	7.38 x 2.81 x 3	8.50 x 2.38	9.38	3.50	3.38	7.88	3.25	.63	2.5	1	1.60	

\* All Circuit Safe pushbutton enclosures are furnished with standard hole dimensions: 1 1/32" diameter with keyways at 12 o'clock and 3 o'clock  
 † Dimensions are in inches unless marked otherwise. Operators not included.

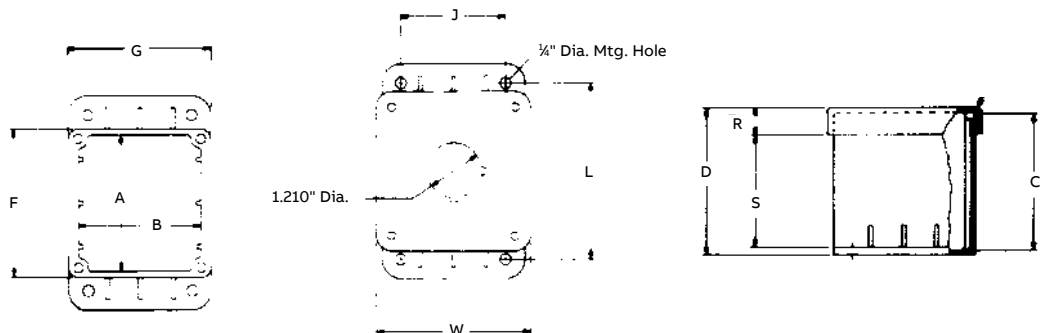

## Narrow-profile blank screw cover enclosures for small instrumentation and control applications

UL® Listed per UL 50 for industrial controls

Meets NEMA 1, 3, 3S, 3X, 3SX, 4, 4X, 12, 13.

Blank cover enclosures can be easily drilled with a standard hole saw for conduit entries and push-buttons. Wallmount enclosures are molded from gray, engineered thermoplastic material and are resistant to most corrosive agents.

**Features and benefits:**

- Brass screw inserts
- Material: nylon base and cover
- Integrally molded mounting flange
- 304 (18-8) stainless screws (10-32/3/8")
- Temperature range: -40° to 185°F



Blank screw cover enclosures\*\*

Cat. No.	Style	Inside box size A x B x C	Mounting L x J	Overall outside including mounting bracket H x W x D					Std. Ctn.	Std. Wt. (lbs.)
				F	G	R	S	D		
CP100NB	Blank Cover	3.13 x 2.81 x 3	4 x 2.38	4.88 x 3.50 x 3.38	3.38	3.25	.63	2.5	12	9.60
CP200NB	Blank Cover	5.38 x 2.81 x 3	6.25 x 2.38	7.13 x 3.50 x 3.38	5.63	3.25	.63	2.5	8	8.8
CP300NB	Blank Cover	7.38 x 2.81 x 3	8.50 x 2.38	9.38 x 3.50 x 3.38	7.88	3.25	.63	2.5	6	8.20

\* All Circuit Safe pushbutton enclosures are furnished with standard hole dimensions: 17/32" diameter with keyways at 12 o'clock and 3 o'clock  
 † Dimensions are in inches unless marked otherwise.

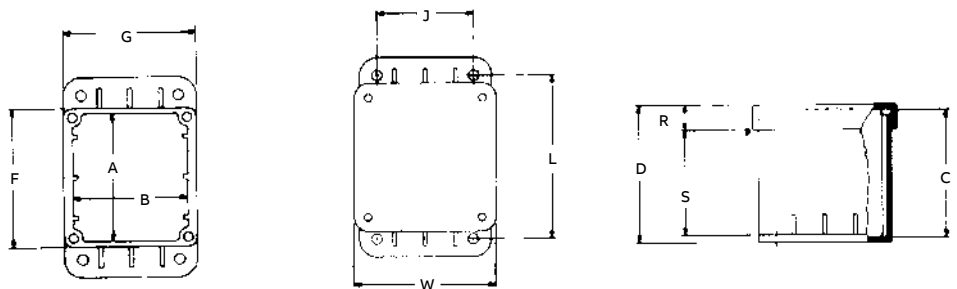

## Hinged cover enclosures with multiple hole openings

Made from engineered thermoplastic material, these enclosures are ideal for applications that require high-impact strength, chemical resistance, high dielectric strength and excellent weathering capabilities, including indoor/outdoor industrial, MRO and OEM applications. Non-metallic hinges are an integral part of the mold. Removable cover enables easy field adjustment. Auxiliary devices must be rated for appropriate NEMA applications.

**Features and benefits:**

- Non-metallic mounting feet and all mounting hardware included
- White-painted 14-gauge steel or 1½" PVC back panel (order separately)
- Material: engineered thermoplastic base and cover
- 304 stainless steel screws
- Brass screw inserts
- Lid design provides greater usable volume
- Completely non-metallic hinges
- Temperature range: -40° to 185°F



**Screw cover pushbutton enclosures with multiple 30.5mm openings\***

Cat. No.	Openings	Inside box size (in.)	Weight (lbs.)	Std. Ctn.	Panel Cat. No.	Size (in.) Steel/PVC
J665P	4	6 x 6 x 5.88	2.42	1	JP66 / JP66P	4.88 x 4.88
J863P	6	8 x 6 x 3.63	1.86	1	JP86 / JP86P	6.75 x 4.88
J1085P	9	10 x 8 x 5.88	3.59	1	JP108 / JP108P	8.75 x 6.88
J12106P	12	12 x 10 x 6.88	4.29	1	JP1210 / JP1210P	10.75 x 8.88
J14126P	20	14 x 12 x 6.88	7.19	1	JP1412 / JP1412P	12.75 x 10.88
J16147P	25	16 x 14 x 7.63	11.20	1	JP1614 / JP1614P	14.75 x 12.88

For enclosures larger than 25 position, please call customer service.  
 \* All Circuit Safe pushbutton enclosures are furnished with standard hole dimensions: 1½" diameter with keyways at 12 o'clock and 3 o'clock.  
 Special openings or positionings available on request.

**Circuit Safe®**  
NEMA Accessories



**Gasketed pushbutton hole plug**

Cat. No.	Size	Std. Ctn.	Std. Wt. (lbs.)
CP900	Standard PB Hole	100	2.0

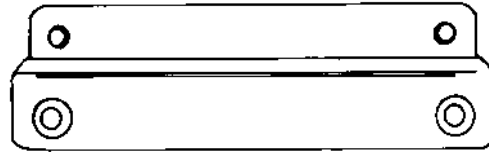

**Mounting rail kits**

Cat. No.	Size (in.)	Std. Ctn.	Std. Wt. (lbs.)
NMK4V	4	25	5
NMK6V	6	24	7.7
NMK8V	8	24	10.25
NMK10V	10	20	13.26
NMK12V	12	20	11.4
NMK14V	14	25	17.76

\*Mounting Rails include two rails and four stainless steel screws.  
Mounting Rails can be mounted on long or short side of enclosure.  
Size mounting flange to side of the enclosure to which the flange will be attached.

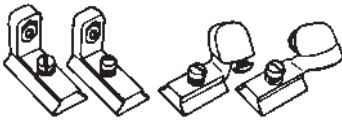

Swing-Out Panel Adjuster Kit (NBPSWG2)



Panel Adjuster Kit (NBPADJ2)



180° Swing-Out Panel Kit (NBPSWG)

**Panel adjuster kits**

Cat. No.	Product	Description	Std. Ctn.	Std. Wt. (lbs.)
NBPADJ2	Panel adjuster kit	(4) Panel adjusters (4) #10-32 screws to mount panel	10 Kits	2.07
NBPSWG	180° swing-out panel kit	(4) Panel adjusters (2) Hinges (2) #10-32 screws to mount panel	10 Kits	2.68
NBPSWG2	Swing-out panel adjuster kit	(2) Hinged adjusters (2) Panel adjusters (4) #10-32 screws	10 Kits	1.80



**Latch kits – For NEMA hinged enclosures**

Cat. No.	Product	Description	Std. Ctn.	Std. Wt. (lbs.)
NPL1L	Non-metallic quick-release latch kit	Quick-release latch kit for use with hidden hinge enclosure for NH & NI Series	25	2.00
NPL1S	Non-metallic quick-release latch kit	Quick-release latch kit for use with external hinge enclosure for NJ & NC Series	25	2.00
SSLL	304 stainless steel quick-release latch kit	Quick-release latch kit for use with hidden hinge enclosure for NH & NI Series	25	4.27
SSLS	304 stainless steel quick-release latch kit	Quick-release latch kit for use with external hinge enclosure for NJ & NC Series	25	3.41

# Circuit Safe®

## JIC accessories

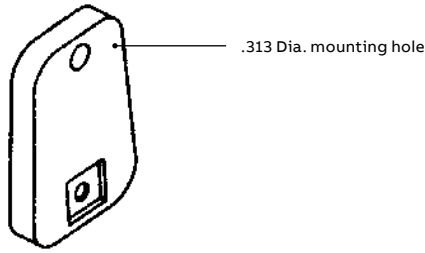

Mounting feet

Cat. No.	Std. Ctn.	Std. Wt. (lbs.)
CJB159*	As required	.04

\*CJB159 non-metallic mounting feet provide 1/8" standoff and may be used to mount enclosures in horizontal or vertical mode. They are shipped with all Circuit Safe® JIC enclosures. No screws are provided when mounting feet are ordered separately.

### JIC installation kit

Cat. No.	Std. Ctn.	Std. Wt. (lbs.)
CH208*	1 Kit	.25

\*Installation kit is included as standard equipment with all JIC enclosures. Information listed here for purposes of additional purchase only. Kit includes four mounting feet, eight hinge caps and eight screws.

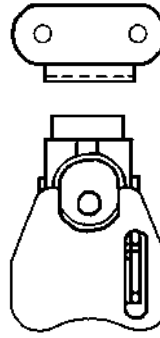

JIC latch kit

Cat. No.	Std. Ctn.	Std. Wt. (lbs.)
CJTL*	As required	.04

Stainless steel. Kit includes latch and keeper.  
\* Factory installed. Consult customer service for price and delivery. Not UL Listed.

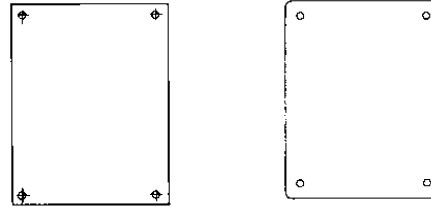

### Medium NEMA back panels\*

Cat. No.	Size (in.)	Std. Ctn.	Std. Wt. (lbs.)
NP2016 / NP2016P	17 x 13	1	7.0/6.125
NP2420 / NP2420P	21 x 17	1	10.4/4.71
NP3024 / NP3024P	27 x 21	1	18.0/9.781

\*Circuit Safe NEMA enclosures are not shipped with back panels, which must be ordered separately.  
All accessories can be factory installed.  
Consult customer service for price and delivery.

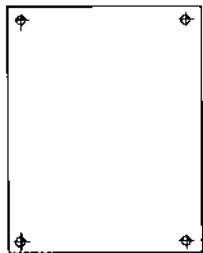

### Steel back panels\* -

Steel back panels are white-painted 14-gauge steel.

Cat. No.	Thickness	Size (in.)	Std. Ctn.	Std. Wt. (lbs.)
JP64	14 gauge	4.88 x 2.88	1	.6
JP66	14 gauge	4.88 x 4.88	1	1.0
JP86	14 gauge	6.75 x 4.88	1	1.0
JP88	14 gauge	6.75 x 6.88	1	1.2
JP108	14 gauge	8.75 x 6.88	1	1.5
JP1010	14 gauge	8.75 x 8.88	1	2.3
JP1210	14 gauge	10.75 x 8.88	1	2.7
JP1212	14 gauge	10.75 x 10.88	1	3.5
JP1412	14 gauge	12.75 x 10.88	1	3.8
JP1614	14 gauge	14.75 x 12.88	1	4.7

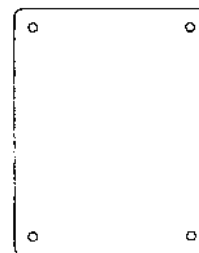

### PVC back panels\* -

PVC back panels are made from 1/4" PVC and meet UL94V-O.

Cat. No.	Size (in.)	Std. Ctn.	Std. Wt. (lbs.)
JP64P	4 7/8 x 2 7/8	1	.3
JP66P	4 7/8 x 4 7/8	1	.3
JP86P	6 3/4 x 4 7/8	1	.4
JP88P	6 3/4 x 6 7/8	1	.5
JP108P	8 3/4 x 6 7/8	1	.7
JP1010P	8 3/4 x 8 7/8	1	.9
JP1210P	10 3/4 x 8 7/8	1	1.2
JP1212P	10 3/4 x 10 7/8	1	1.5
JP1412P	12 3/4 x 10 7/8	1	1.7
JP1614P	14 3/4 x 12 7/8	1	2.3

**Circuit Safe®**

NEMA and JIC Accessories

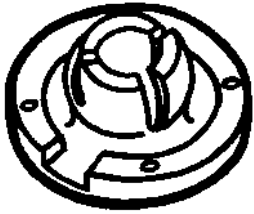

**Draining device\*** – For 3R Rating and condensation buildup

Cat. No.	Std. Ctn.
HPVEA9	30

\*Factory installation available.



**Air vents\*** – NEMA 1 Rated only

Cat. No.	Style	Std. Ctn.
HPVM25	For fitting outside of all enclosures	30
HPVM35	For fitting inside of all enclosures	30

\*Factory installation available.

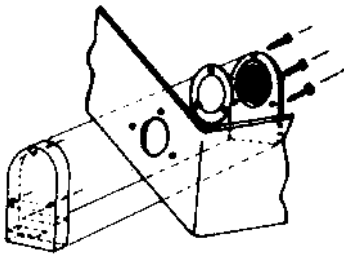

**Enclosure ventilator\*** – Enables any size enclosure to breathe, yet remain watertight

Cat. No.	Std. Ctn.
HVM27	15

\*Factory installation available.

# Window Kits

Carlton® hinged window kits are used to create a NEMA 4X environment on electronic control panels. Polycarbonate construction and double gaskets ensure environmental integrity.

**Features and benefits:**

- High-impact strength
- High dielectric strength
- Suitable for indoor and outdoor use
- Fully gasketed

**Standards:**

- UL Listed and meets NEMA Type 4X with the exception of NI1614W; all sizes are NEMA Type 1 and 12 rated

**Applications:**

- Instrument case
- Junction and terminal boxes
- Control and switching enclosures
- Meter and transformer cabinets
- Small device enclosures
- Surface-mounted instruments

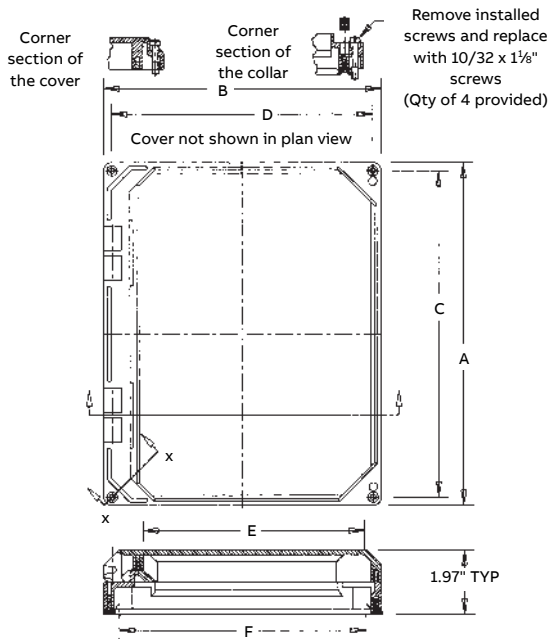

Cat. No.	Size (in.)	Std. Ctn.	Std. Wt. (lbs.)
NI64W	6 x 4	1	.8
NI66W	6 x 6	1	.9
NI86W	8 x 6	1	1.17
NI88W	8 x 8	1	1.4
NI108W	10 x 8	1	1.5
NI1010W	10 x 10	1	1.82
NI1210W	12 x 10	1	2.12
NI1212W	12 x 12	1	2.65
NI1412W	14 x 12	1	2.67
NI1614W	16 x 14	1	3.10

All window kits can be factory installed to Carlton® enclosures. Consult factory for price and delivery.  
 \* Non-stock factory order only — consult customer service.  
 NI1614W is not NEMA Type 4X Rated

Size	Dimensions (IN.)					
	A	B	C	D	E	F
NI64W	6.42 (163.1)	4.41 (112.0)	5.92 (150.4)	3.94 (100.0)	2.72 (69.1)	3.80 (96.5)
NI66W	6.42 (163.1)	6.42 (163.1)	5.94 (150.9)	5.94 (150.9)	4.72 (119.9)	5.80 (147.3)
NI86W	8.44 (214.4)	6.42 (163.1)	7.92 (201.2)	5.94 (150.9)	4.72 (119.9)	5.80 (147.3)
NI88W	8.44 (214.4)	8.43 (214.1)	7.95 (201.9)	7.95 (201.9)	6.72 (170.7)	7.80 (198.1)
NI108W	10.46 (265.7)	8.45 (214.6)	9.95 (253.5)	7.96 (202.2)	6.72 (170.7)	7.80 (198.1)
NI1010W	10.45 (265.4)	10.45 (265.4)	9.97 (253.2)	9.97 (253.2)	8.72 (221.5)	9.80 (248.9)
NI1210W	12.46 (316.5)	10.45 (265.4)	11.99 (304.5)	9.97 (253.2)	8.72 (221.5)	9.80 (248.9)
NI1212W	12.50 (317.5)	12.50 (317.5)	12.00 (304.8)	12.00 (304.8)	10.72 (272.3)	11.80 (299.7)
NI1412W	14.50 (368.3)	12.50 (317.5)	14.01 (355.9)	12.00 (304.8)	10.72 (272.3)	11.80 (299.7)
NI1614W	16.52 (419.6)	14.48 (367.8)	16.03 (407.2)	14.02 (356.1)	12.72 (323.1)	13.80 (350.5)

Note: Chart dimensions read in (mm)

# Himeline® Enclosures

## HS, HP, HLA/HLS Series

Carlson® Himeline® enclosures are the ideal alternative to expensive stainless steel enclosures. They have excellent corrosion-resistant properties and are impervious to sunlight, dirt and moisture. Available in four series (HS, HP and HLA/HLS), with sizes ranging from 11 x 7 x 7 through 50 x 40 x 17, these enclosures offer choices that include double doors, clear or opaque covers, hinged and screw versions, single- or three-point closure mechanisms, 4X windows, DIN rail mounting and an adjustable depth door-in-door option that enables you to customize your enclosures by separating power from communications.

**Features and benefits:**

- High-impact strength
- High dielectric strength
- Suitable for indoor and outdoor use
- Fully gasketed
- Lightweight

**Applications:**

- Instrument case
- Junction and terminal boxes
- Control and switching enclosures
- Meter and transformer cabinets
- Small device enclosures

**Standards:**

- Meets NEMA and IP standards as indicated in appropriate section
- UL® Listed as indicated



# HS Series screw-on

## Fastened and hinged cover enclosures

- Meets NEMA 1, 3, 3S, 4, 4X, 12, 13
- Meets IP 65

Himeline® HS Series enclosures are designed for use as junction boxes, terminal wiring boxes, instrument and control housings and small device enclosure applications. Molded under high pressure, Himeline® HS Series enclosures provide high-impact strength, chemical resistance, high dielectric strength and excellent weathering capabilities.

**Features and benefits:**

- Standard slotted locking screw
- High-impact strength
- Chemical resistance
- High dielectric strength
- Excellent weathering capabilities
- Sealing gasket on all models

**Applications:**

- Junction boxes
- Terminal wiring boxes
- Instrument and control housings
- Small device enclosure applications
- Indoor or outdoor use

**Material:**

- Opaque/clear Lid – polycarbonate
- Base – Fiberglass reinforced polyester

**Standards:**

- Meets NEMA Type 1, 3, 3S, 4, 4X, 12, 13 ratings
- UL Listed per UL 50, enclosures for electrical equipment
- Meets IP 65
- UL® Listed (E108856)



## HS Series screw-on

Fastened and hinged cover enclosures



**Features and benefits:**

- Molded under high pressure
- High-impact strength
- Chemical resistance
- High dielectric strength
- Excellent weathering capabilities
- Clear cover available



Opaque Screw-On Cover Cat. No.	Clear Screw-On Cover Cat. No.	Opaque Hinged Cover Cat. No.	Clear Hinged Cover Cat. No.	Dimensions (in.)						Opaque Wt. (lbs.) each Screw/hinged	Clear Wt. (lbs.) each		Back Panel Cat. No.	Dimensions (in.) H x W	Thick-ness (in.)	Std. Wt. (lbs.)	Std. Ctn.
				External			Internal				Screw/hinged	Std. Ctn.					
				A	B	C	D	E	F								
HS7A7	HS7A7C	HH7A7	HH7A7C	10.63	7.09	7.09	6.26	9.80	6.54	10.7/7	10.9/6.2	4	HS7ABP	5.51 x 9.05	.08	1.1	1
HS11A7	HS11A7C	HH11A7	HH11A7C	10.63	10.63	7.09	9.80	9.80	6.54	15.2/8.5	14/8	4	HS11ABP	9.05 x 9.05	.08	1.7	1
HS11B7	HS11B7C	HH11B7	HH11B7C	14.17	10.63	7.09	9.80	13.35	6.54	17/4	18/4	4	HS11BBP	9.05 x 12.60	.08	2.4	1
HS11C7	HS11C7C	HH11C7	HH11C7C	21.26	10.63	7.09	9.80	20.43	6.54	13/13	12.5/13	2	HS11CBP	9.05 x 19.68	.08	3.9	1
HS15C7	HS15C7C	HH15C7	HH15C7C	21.26	14.17	7.09	13.35	20.43	6.54	17.7/11	18/11	2	HS15CBP	12.60 x 19.68	.08	6.6	1
HS21C7	HS21C7C	HH21C7	HH21C7C	21.26	21.26	7.09	20.43	20.43	6.54	12.5/13	12/13	1	HS21CBP	19.68 x 19.68	.08	8.8	1
HS11A9	HS11A9C	HH11A9	HH11A9C	10.63	10.63	9.06	9.80	9.80	8.47	15/4	16.6/5	4	HS11ABP	9.05 x 9.05	.08	1.7	1
HS11B9	HS11B9C	HH11B9	HH11B9C	14.17	10.63	9.06	9.80	13.35	8.47	20/6	19/6	4	HS11BBP	9.05 x 12.60	.08	2.5	1
HS11C9	HS11C9C	HH11C9	HH11C9C	21.26	10.63	9.06	9.80	20.43	8.47	14/9	14/9	2	HS11CBP	9.05 x 19.68	.08	3.9	1
HS15C9	HS15C9C	HH15C9	HH15C9C	21.26	14.17	9.06	13.35	20.43	8.47	18.5/11	19/11	2	HS15CBP	12.60 x 19.68	.08	6.6	1
HS21C9	HS21C9C	HH21C9	HH21C9C	21.26	21.26	9.06	20.43	20.43	8.47	13/14	14/14	1	HS21CBP	19.68 x 19.68	.08	8.8	1
HS15D9	HS15D9C	HH15D9	HH15D9C	28.35	14.17	9.06	13.35	27.52	8.47	13/13	13/13	1	HS15DBP	12.60 x 26.77	.10	9.5	1
HS21D9	HS21D9C	HH21D9	HH21D9C	28.35	21.26	9.06	20.43	27.52	8.47	18/18	17/18	1	HS21DBP	19.68 x 26.77	.10	15.5	1

Back panels and mounting feet must be ordered separately. Consult customer service for availability and delivery.

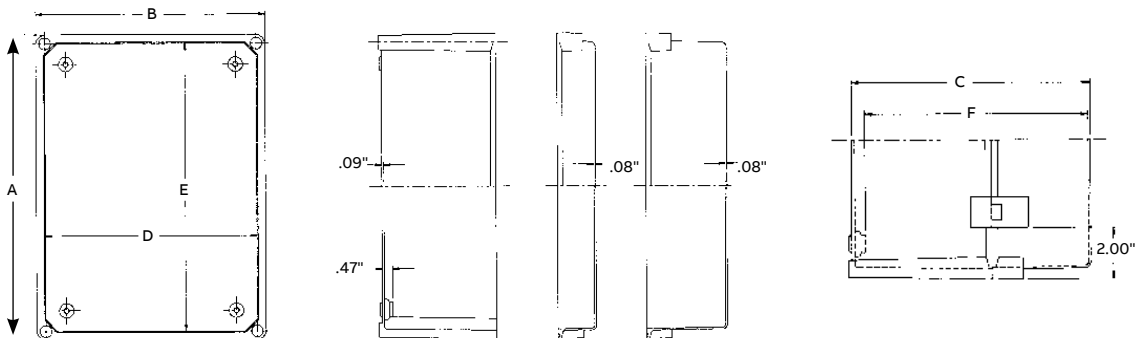

## HS Series

### Accessories

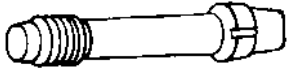

**Thumb screws** – For Himeline® HS enclosures

Cat. No.	Std. Ctn.	Std. Wt. (lbs.)
HSTS4	25	0.1
HSTS6	25	0.15

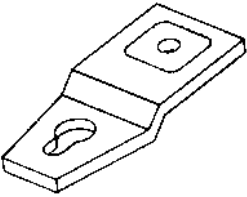

**Thumb screws** – For Himeline® HS enclosures

Cat. No.	Description	Std. Ctn.	Std. Wt. (lbs.)
HSMFZ	Zinc dichromated steel	25	0.2
HSMFSS	304 Stainless steel	25	0.2

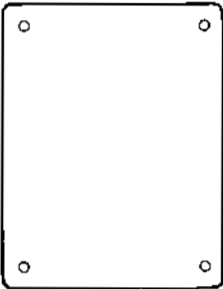

**Back panels\*** – For Himeline® HS enclosures.  
metal back panels are white-painted 14-gauge steel

Cat. No.	Size (in.)	Std. Ctn.	Std. Wt. (lbs.)
HST7ABP	5.51 x 9.05	1	1.2
HS11ABP	9.05 x 9.05	1	2.0
HS11BBP	9.05 x 12.06	1	2.7
HS11CBP	9.05 x 19.68	1	4.3
HS15CBP	12.60 x 19.68	1	7.1
HS21CBP	19.68 x 19.68	1	9.6
HS15DBP	12.60 x 26.77	1	10.2
HS21DBP	19.68 x 26.77	1	16.6

\*Himeline HS enclosures are not shipped with back panels. Order separately.  
PVC back panels available upon request. Consult customer service.

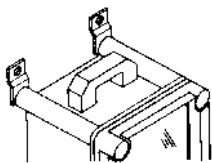

**Non-metallic carrying handle** –  
Converts enclosures to portable units for meters and portable power

Cat. No.	Std. Ctn.	Std. Wt. (lbs.)
HSCH	10	0.2

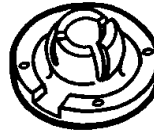

**Draining device\*** – For 3R Rating and condensation build up

Cat. No.	Std. Ctn.
HPVEA9	30

\*Factory installation available.



**Air vents\*** – NEMA 1 Rated only

Cat. No.	Style	Std. Ctn.
HPVM25	For fitting outside of all enclosures	30
HPVM35	For fitting inside of all enclosures	30

\*Factory installation available.

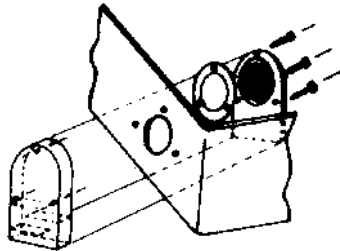

**Enclosure ventilator\*** –  
Enables any size enclosure to breathe, yet remain watertight

Cat. No.	Std. Ctn.
HVM27	15

\*Factory installation available.

# HP Series enclosures

## With hinged quick-release cover

- Meets NEMA 1, 3, 3S, 4, 4X, 12, 13
- Meets IP 66

Himeline® HP Series enclosures for medium-sized devices and equipment provide superior performance as junction and terminal wiring boxes and instrument and control housing applications.

For indoor/outdoor industrial, MRO and OEM applications. HP Series enclosures are resistant to corrosion, sunlight, chemicals, dirt and moisture. Temperature range from -58°F to 320°F.



### Features and benefits:

- Projections for affixing cover mounted panel
- Door-locking mechanism convertible to key lock
- M8x18 studs for back panel mounting (included)
- Hidden hinges open 185°For easy access
- Multi-positional DIN rail fixing components
- Removable stainless steel hinge pins
- Single-piece construction
- Opaque or tempered glass window option
- Steel, non-metallic and slotted back panels available
- External and internal venting available
- Hinged, variable-height inner panel option
- Quick-locking ¼-turn entry
- Underside grid pattern on inner door panel
- Self-positioning panel depth adjusters
- Pole mounting kit
- Pedestal mounting capability
- Sunlight resistant

### Applications:

- Junction boxes
- Terminal wiring boxes
- Instrument and control housing
- Indoor or outdoor use

### Standards:

- NEMA Type 1, 3, 3S, 4, 4X, 12, 13
- UL® Listed per UL 50, enclosures for electrical equipment
- Meets IP 66

### Material:

- Lids/Bases – fiberglass-reinforced polyester

## HS Series enclosures

With hinged quick-release cover



Enclosure With Opaque Cover Cat. No.	Std. Wt. (lbs.)	Enclosure with Clear Window*	Std. Wt. (lbs.)	Window Dimensions (H x W) (in.)	Dimensions (in.)										Std. Ctn.
					External			Internal			Mounting		Window		
					A	B	C	D	E	F	G	H	J	K	
HP1612B	11.04	HC1612B	12.5	11 x 7.87	16.93	12.99	7.87	14.96	10.24	6.61	14.76	5.91	11.02	7.87	1
HP2016B	16.80	HC2016B	17.2	14.96 x 11.81	20.87	16.93	7.87	18.90	14.17	6.61	18.70	9.84	14.96	11.81	1
HP2416C	21.13	HC2416C	24.12	18.89 x 11.81	25.47	17.17	9.84	22.83	14.17	8.35	22.64	9.84	18.90	11.81	1
HP3020D	32.28	HC3020**	36.02	22.83 x 15.74	29.41	21.10	11.81	26.77	18.11	10.28	26.57	13.78	22.83	15.75	1
HP3325D	39.00	HC3325D**	43.12	26.77 x 19.68	33.35	25.04	11.81	30.71	22.05	10.28	30.51	17.72	26.77	19.69	1

\* HC Enclosures are IP 65 Rated. Clear window is glass.  
 \*\* This series of enclosures comes standard with body, lid and mounting rail kit. Consult Customer Service for availability and delivery.

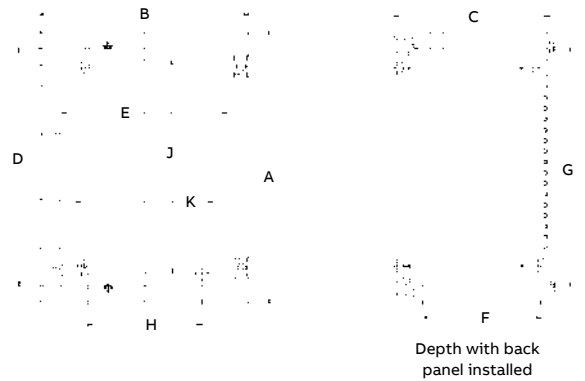

## Hinged internal door

### Features and benefits:

- Internal fiberglass-reinforced polyester door assembly
- Grid pattern on the inside for quicker positioning of equipment
- Quick-locking 1/4-turn entry

Cat. No.	A		A		A		A		Std. Ctn.	Std. Wt. (lbs.)
	in.	(mm)	in.	(mm)	in.	(mm)	in.	(mm)		
PID1612	12.40	(315)	18.07	(205)	5.98	(152)	1.02	(26)	1	2.05
PID2016B	16.34	(415)	12.00	(305)	5.98	(152)	1.02	(26)	1	3.15
PID2416C	20.28	(515)	12.00	(305)	7.64	(194)	1.26	(32)	1	4.50
PID3020D	24.21	(615)	15.94	(405)	9.61	(244)	1.26	(32)	1	6.50
PID3325D	28.15	(715)	19.88	(505)	9.61	(244)	1.26	(32)	1	8.45

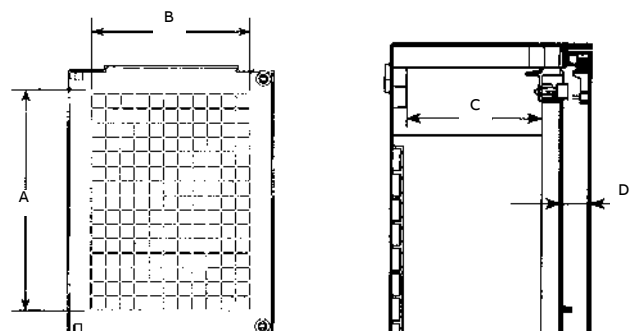

## HS Series back panels

A complete range of plates – directly fix to the enclosure supports or to the adjustable depth supports.

**Steel back panels** – Steel back panels are white-painted 14-gauge steel

Cat. No.	To Fit Enclosures	Thickness		Weight		P (in.)	S (in.)
		in.	(mm)	lbs.	(kg)		
PMM1612	HP1612B	.079	(2)	3.10	(1.6)	14.37	9.84
PMM2016	HP2016B	.079	(2)	6.15	(2.5)	18.30	13.78
PMM2416	HP2416C	.079	(2)	8.0	(3.1)	22.24	13.78
PMM3020	HP3020D	.079	(2)	12.04	(4.6)	26.18	17.72
PMM3325	HP3325D	.118	(3)	20.0	(9.9)	30.11	21.65

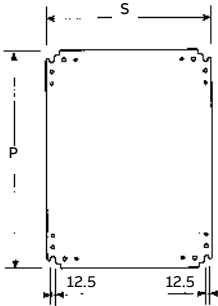

**PVC insulating back panels** – PVC back panels are made from 1/4" PVC and meet UL94V-O

Cat. No.	To Fit Enclosures	Weight		P		S	
		lbs.	(kg)	in.	(mm)	in.	(mm)
PMB1612	HP1612B	1.10	(0.5)	14.37	(365)	9.84	(250)
PMB2016	HP2016B	2.65	(1.2)	18.30	(465)	13.78	(350)
PMB2416	HP2416C	3.09	(1.4)	22.24	(565)	13.78	(350)
PMB3020	HP3020D	4.63	(2.1)	26.18	(665)	17.72	(450)
PMB3325	HP3325D	6.62	(3.0)	30.11	(765)	21.65	(550)

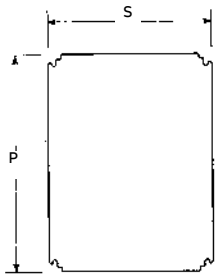

**PVC insulating back panels** – Zinc, dichromated, coated-steel plates perforated for addition of electrical circuitry

Cat. No.	To Fit Enclosures	Weight		D		E	
		lbs.	(kg)	in.	(mm)	in.	(mm)
PMR1612	HP1612B	1.54	(0.7)	13.74	(349)	9.8	(251)
PMR2016	HP2016B	2.87	(1.3)	17.72	(450)	13.82	(351)
PMR2416	HP2416C	3.53	(1.6)	21.85	(555)	13.82	(351)
PMR3020	HP3020D	5.07	(2.3)	25.39	(645)	17.76	(451)
PMR3325	HP3325D	7.06	(3.2)	29.53	(750)	21.69	(551)

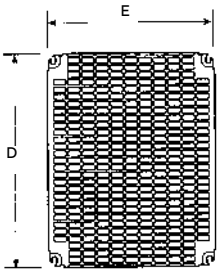

## HP Series Accessories

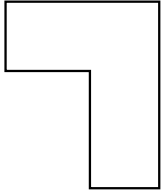

**Blanking grommet** – To close off openings on enclosure backs

Cat. No.	Fits Enclosure Sizes	Description	Std. Ctn.	Std. Wt. (lbs.)
HPBNGB	16 x 12 and 20 x 16	Blanking Grommet	10	1.00
HPBNGC	24 x 16, 30 x 20 and 33 x 25	Blanking Grommet	20	1.00

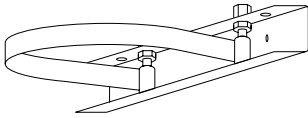

**Pole mounting set**

Cat. No.	To Fit Enclosures	Std. Ctn.
HPPF300	HP1612B	1
HPPF400	HP2016B, HP2416C	1
HPPF500	HP3020D	1
HPPF600	HP3325D	1

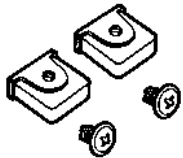

**Rail mounting insert**

Cat. No.	Features	Std. Ctn.
HPRFK	Fits All Enclosures	10

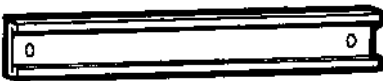

**35mm Symmetrical DIN rail**

Cat. No.	Fits Enclosure	Width (in.)	Std. Ctn.
HPCO300	HP1612B	11.02	25
HPCO400	HP2016B, HP2416C	14.96	2
HPCO500	HP3020D	18.90	50



**Wall mounting set**

Cat. No.	Std. Ctn.	Std. Wt. (lbs.)
HPWMF	10	.1

Includes brass inserts and installation tools.



**Fixing accessories for slotted plates**

Fixing Nut			Fixing bolt with washer		
Cat. No.	Type Of Thread	Std. Ctn.	Cat. No.	Length (in.)	Std. Ctn.
HPFA4	M4	8	HPFB104	.39	1000
HPFA4	M4	8	HPFB164	.63	1000
HPFA5	M5	8	HPFB125	.47	1000
HPFA5	M5	8	HPFB185	.71	1000
HPFA6	M6	8	HPFB126	.47	1000
HPFA6	M6	8	HPFB186	.71	1000

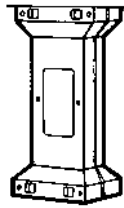

**Pedestal mount**

Cat. No.	To Fit Enclosures	Std. Ctn.
HPSFS1	HP2016B, HP2416C	1

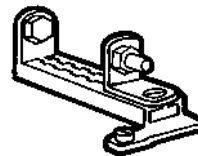

**Back panel depth adjustable supports** - Supports designed to fit 7.87" (200mm), 9.84" (250mm), 11.81" (300mm) and 13.78" (350mm) deep enclosures. Self-positioning slots enable adjustment every .49" (12.5mm). Made of zinc dichromated coated steel.

Cat. No.	To Fit Enclosures	A	B	Std. Ctn.
		in./mm	in./mm	
HPLM200	HP1612B & HP2016B	5.98/152	3.90/99	8
HPLM250	HP2416C	8.07/205	4.13/105	15
HPLM300	HP3020D & HP3325D	10.04/255	8.07/205	10

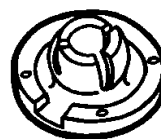

**Draining device\*** – For 3R rating and condensation buildup.

Cat. No.	Std. Ctn.
HPVEA9	30

\*Factory installation available.

**HP Series**

Accessories



**Air vents\*** – NEMA 1 Rated only

Cat. No.	Style	Std. Ctn.
HPVM25	For Fitting Outside of All Enclosures	30
HPVM35	For Fitting Inside of All Enclosures	30

\*Factory installation available.

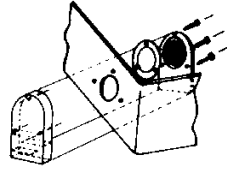

**Enclosure ventilator\*** – Enables any size enclosure to breathe, yet remain watertight

Cat. No.	Std. Ctn.
HVM27	15

\*Factory installation available.



**Replacement standard handle**

Cat. No.	Std. Ctn.	Std. Wt. (lbs.)
HPRSH	1	.05

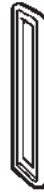

**Coupling frame** – For Himeline HP Enclosures HP3020D and HP3325D.

Cat. No.	Std. Ctn.
HPBU	1

**Locks**

For Himeline® HP enclosures

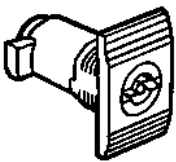

**Replacement door lock**

Cat. No.	Std. Ctn.
HPRLA	15

For replacement handle, order HPRSH.

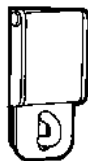

**Padlocking service**

Cat. No.	Std. Ctn.
HPPLH	20



**Cylinder key lock (keyed alike)**

Cat. No.	Std. Ctn.
HPTPLM	15

For replacement key, order HPRKO.

# HLA/HLS Series Enclosures

Carlton® Himeline® HLA/HLS Series Enclosures are large fiber-reinforced polyester cabinets ranging in sizes 20 x 20 x 17 to 50 x 40 x 17 and 20 x 20 x 12 to 50 x 40 x 12, respectively. They have operating temperatures of -50° to 150°C and can accommodate large devices and equipment for a wide range of applications, including junction and terminal wiring boxes, instruments and control housings. They are ideal for indoor/outdoor industrial, MRO and OEM applications, and offer superior strength and high resistance to corrosion, moisture, dust, oil and UV light, enabling them to withstand the harshest of environments.

The HLA/HLS Series Enclosures are fitted with a watertight gasket and are available in one- and two-door configurations. These cabinets have a closed top and bottom and the two-door version includes a central upright to maintain rigidity.

To maintain the watertight seal, the locking mechanism is positioned outside the gasketed area. A wide variety of accessories are available such as steel and non-metallic back panels, self-positioning panel depth adjusters and ventilator kits.

Carlton® Enclosures...the ideal alternative to expensive stainless steel enclosures.

**Features and benefits:**

- Fiber-reinforced polyester
- Temperature range of -58° to 302°F (-50° to 150°C)
- Indoor/outdoor applications
- Superior strength
- High resistance to harsh environments
- Watertight gasket seal
- One- and two-door configurations
- Locking mechanism and hinge are outside gasketed area
- Floor or wall mounted

**Applications:**

- Contain large devices and equipment
- Junction and terminal wiring boxes
- Instrument and control housings

**Standards:**

- IP 65 Rating (single-door versions only)
- 4/4X Rated (single-door versions only)
- UL® Listed



**One-door NEMA Types 1, 2, 3, 3R, 4, 4X, 5, 12, 13**

HLA/HLS Series single- and double-hinged cover enclosures with latches\*



**HLA one door (17" Deep)**

Cat. No.	Dimensions (in.)			Std. Ctn.	Std. Wt. (lbs.)
	H	W	D		
HLA2020	20	20	17	1	38.3
HLA2030	20	30	17	1	53.9
HLA3020	30	20	17	1	53.9
HLA3030	30	30	17	1	60.7
HLA4020	40	20	17	1	63.1
HLA4030	40	30	17	1	81.0
HLA5020	50	20	17	1	78.7
HLA5030	50	30	17	1	96.7

\* Consult customer service for availability and delivery.



**HLA two door (17" Deep)**

Cat. No.	Dimensions (in.)			Std. Ctn.	Std. Wt. (lbs.)
	H	W	D		
HLA30402	30	40	17	1	81.0
HLA40402	40	40	17	1	114.7
HLA40502	40	50	17	1	135.0
HLA50402	50	40	17	1	135.0



**HLS one door (12" Deep)**

Cat. No.	Dimensions (in.)			Std. Ctn.	Std. Wt. (lbs.)
	H	W	D		
HLS2020	20	20	12	1	29.8
HLS2030	20	30	12	1	40.59
HLS3020	30	20	12	1	49.5
HLS3030	30	30	12	1	55.1
HLS4020	40	20	12	1	56.81
HLS4030	40	30	12	1	61.7
HLS5020	50	20	12	1	67.56
HLS5030	50	30	12	1	76.83

\* Consult customer service for availability and delivery.



**HLS two door (12" Deep)**

Cat. No.	Dimensions (in.)			Std. Ctn.	Std. Wt. (lbs.)
	H	W	D		
HLS30402	30	40	12	1	62.57
HLS40402	40	40	12	1	87.59
HLS40502	40	50	12	1	104.28
HLS50402	50	40	12	1	104.28

## HLA/HLS Series

### Accessories

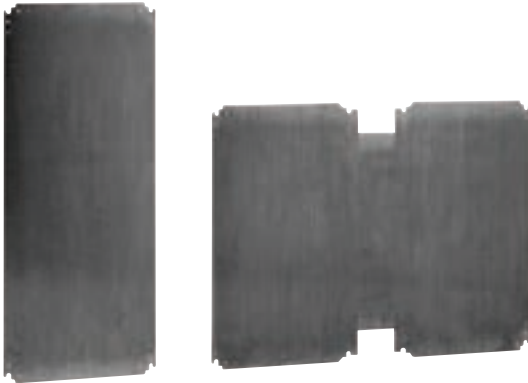

#### Non-metallic thermosetting plastic (Bakelite) – one door

Cat. No.	Dimensions (in.)		Std. Ctn.	Std. Wt. (lbs.)
	H	W		
LP2020BP	15.4	14.8	1	2.1
LP3020BP*	25.2	14.8	1	3.0
LP3030BP	25.2	24.6	1	6.3
LP4020BP	35.0	14.8	1	5.2
LP4030BP	35.0	24.6	1	8.8
LP5020BP	44.3	14.8	1	6.7
LP5030BP	44.3	24.6	1	11.2

\* Use back panel LP3020BP for enclosures HLA2030, HLA3020, HLS2030 and HLS3020

#### Non-metallic thermosetting plastic (Bakelite) – two door

Cat. No.	Dimensions (in.)		Std. Ctn.	Std. Wt. (lbs.)
	H	W		
P30402BP	25.2	34.4	1	8.8
LP40402BP	35.0	34.4	1	12.3
LP40502BP	35.0	44.3	1	16.1
LP50402BP	44.3	34.4	1	16.1

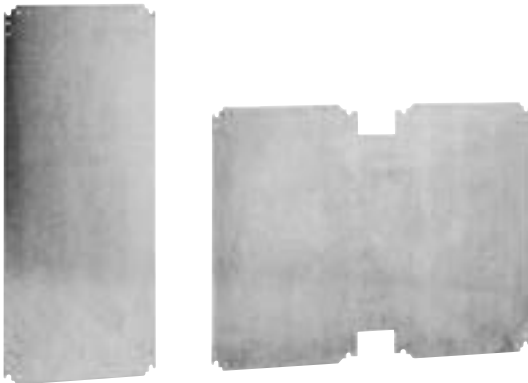

#### Metal - galvanized steel – one door

Cat. No.	Dimensions (in.)		Std. Ctn.	Std. Wt. (lbs.)
	H	W		
LA2020BP	15.4	14.8	1	5.6
LA3020BP*	25.2	14.8	1	8.6
LA3030BP	25.2	24.6	1	17.6
LA4020BP	35.0	14.8	1	14.6
LA4030BP	35.0	24.6	1	24.3
LA5020BP	44.3	14.8	1	19.4
LA5030BP	44.3	24.6	1	31.9

\* Use back panel LA3020BP for enclosures HLA2030, HLA3020, HLS2030 and HLS3020

#### Metal - galvanized steel – two door

Cat. No.	Dimensions (in.)		Std. Ctn.	Std. Wt. (lbs.)
	H	W		
LA30402BP	25.2	34.4	1	24.1
LA40402BP	35.0	34.4	1	33.8
LA40502BP	35.0	44.3	1	43.4
LA50402BP	44.3	34.4	1	43.7

**HLA/HLS Series**  
Accessories



Panel adjuster kit

Cat. No.	Std. Ctn.	Std. Wt. (lbs.)
HLAMFSS	1 each (set of 4)	.6



Panel adjuster kit

Cat. No.	Std. Ctn.	Std. Wt. (lbs.)
HLABPA4	1 each (set of 4)	.31



Padlock device

Cat. No.	Std. Ctn.	Std. Wt. (lbs.)
HLAPAD	8	.61

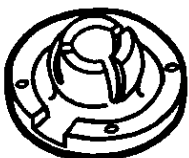

Draining device\*

Cat. No.	Std. Ctn.
HPVEA9	30

For 3R Rating and condensation buildup.  
\*Factory installation available.



Replacement handle with cylinder key lock

Cat. No.	Std. Ctn.	Std. Wt. (lbs.)
HLATEL	8	.41



Standard replacement bar lock with key

Cat. No.	Std. Ctn.	Std. Wt. (lbs.)
HLATD	30	.21

Replacement handle with pushbutton

Cat. No.	Std. Ctn.	Std. Wt. (lbs.)
HLAHAN	8	.40



Air vents\*

Cat. No.	Style	Std. Wt. (lbs.)
HPVM25	For fitting outside of all enclosures	1
HPVM35	For fitting inside of all enclosures	1

NEMA 1 Rated only.  
\*Factory installation available.

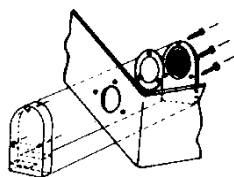

Enclosure ventilator\*

Cat. No.	Std. Ctn.
HVM27	15

Enables any size enclosure to breathe, yet remain watertight.  
\*Factory installation available.

# HLP Series

## Enclosure and pedestal

—  
01 Pedestal  
—  
02 Enclosure

Himeline® HLP enclosures and pedestals are designed to accommodate all types of electrical equipment for electrical distribution applications.

The enclosure may be directly installed on the ground or on top of a pedestal, and the pedestal is approved for direct-burial applications.

Both are manufactured using fiber-reinforced polyester to provide high-impact resistance and enable effortless modifications. And, each has an IP43 self-ventilated and IP54 watertight rating and a temperature range of -58°F to 302°F.

### Enclosure features:

- High impact resistance
- Non-conductive and non-corrosive
- Fits all type of electrical equipment
- IP43 self-ventilated
- IP54 watertight
- One- and two-door configurations
- Install directly on the ground or on a pedestal
- Removable inner hinges for great access
- Doors open 180°

### Pedestal features:

- Can be direct buried
- Non-conductive and non-corrosive
- Detachable upper front for easy access
- High impact resistance
- Auxiliary outlet on the side
- IP43 self-ventilated
- IP54 watertight
- Floor- or wall-mountable

### Material:

- Fiberglass-reinforced polyester



01

02

Applications:

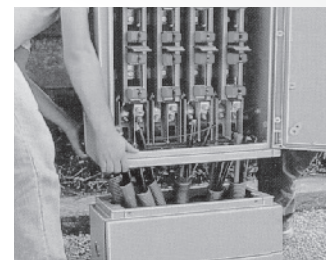
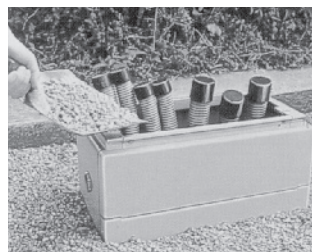
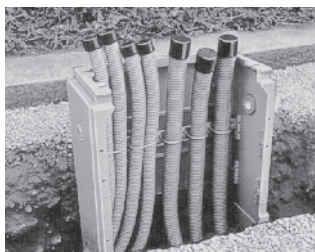

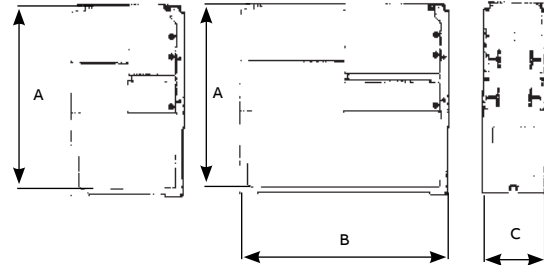
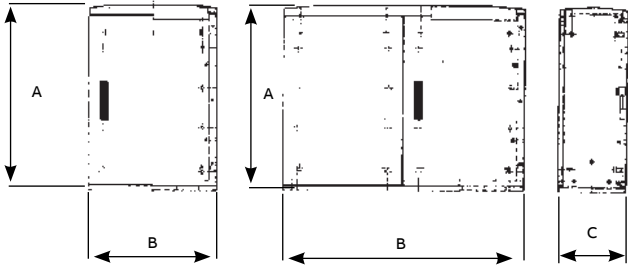

**Enclosures**

Cat. No.	No. of Doors	No. of Locks	Dimensions (in.)			Std. Ctn.	Std. Wt. (lbs.)
			A Height	B Width	C Depth		
HLP3318	1	1	33.46	18.31	12.60	1	40.79
HLP3323	1	1	33.46	23.23	12.60	1	48.50
HLP3331	1	1	33.46	30.91	12.60	1	55.12
HLP33442	2	1	33.46	43.90	12.60	1	77.16
HLP33442L	2	2	33.46	43.90	12.60	1	77.16

Consult customer service for availability and delivery.

**Pedestals**

Cat. No.	Dimensions (in.)			Std. Ctn.	Std. Wt. (lbs.)
	H	W	D		
HLPED3318	35.43	18.31	12.20	1	33.10
HLPED3323	35.43	23.23	12.20	1	37.48
HLPED3331	35.43	30.91	12.20	1	44.10
HLPED33442	35.43	43.90	12.20	1	55.12
HLPED33442L	35.43	43.90	12.20	1	55.12

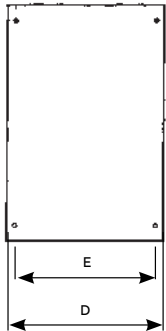

**Mounting plates**

Cat. No.	Enclosure Cat. No.	Pedestal Cat. No.	# of Plates per Encl.	Dimensions (in.)		Thickness (in.)	Std. Ctn.	Std. Wt. (lbs.)
				D	E			
LA1412BP	HLP3318	HLPED3318	1	14.02	11.97	.20	1	4.41
LA1816BP	HLP33442L	HLPED33442L	2	17.64	15.59	.20	1	11.02
LA1916BP	HLP3323	HLPED3323	1	18.94	16.89	.20	1	6.00
LA2725BP	HLP3331	HLPED3331	1	26.61	24.57	.20	1	8.38

Consult customer service for availability and delivery.

**HLP Series**

Accessories

**Gasket**

Cat. No.	Size (in.) H x W x D	Std. Ctn.	Std. Wt. (lbs.)
HLP3318G	33 x 18 x 12	1	2.2
HLP3323G	33 x 23 x 12	1	2.2
HLP3331G	33 x 31 x 12	1	2.2
HLP3344G	33 x 44 x 12	1	2.2

Consult customer service for availability and delivery.

---

# Slack and Splice Enclosures

Carlson's® state-of-the-art modification capabilities enable design of slack and splice enclosures to meet specific application requirements.

**Features and benefits:**

- Slack and splice enclosures provide maximum protection of slack fiber and splice unit assemblies
- Eliminates need for difficult aerial and vault splicing
- Stores adequate slack fiber to facilitate splicing at ground level work station
- Enclosure sized to maintain minimum required radius of fiber optic cable



## Slack Enclosures

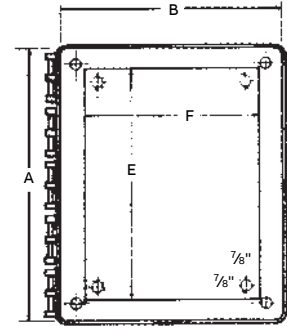
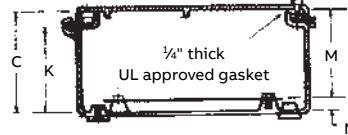
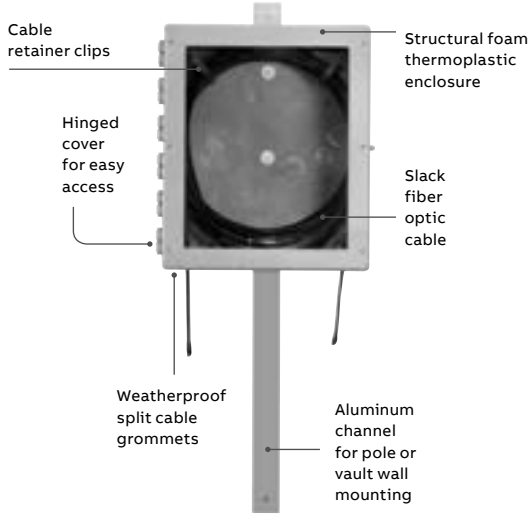

UL US LISTED E108856 LR31146

Cat. No.	Inside Box Size (in.)	Box Opening (in.)		Dimensions (in.)		
	A x B x C	E x F	K	M	N	
SLK11	30 x 24 x 11½	27¼ x 21¼	10¼	10½	1	
SLK12	30 x 24 x 9½	27¼ x 21¼	8¼	8½	1	
SLK21	24 x 20 x 11½	21¼ x 17¼	10¼	10½	1	
SLK22	24 x 20 x 9½	21¼ x 17¼	8¼	8½	1	
SLK31	20 x 16 x 11½	17¼ x 13¼	10¼	10½	1	
SLK32	20 x 16 x 9½	17¼ x 13¼	10¼	10½	1	

## Splice Enclosures

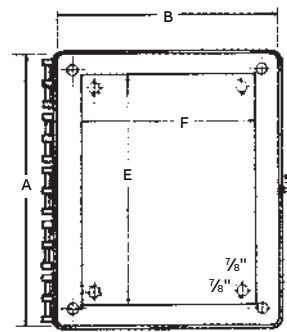
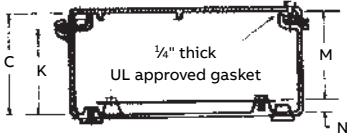
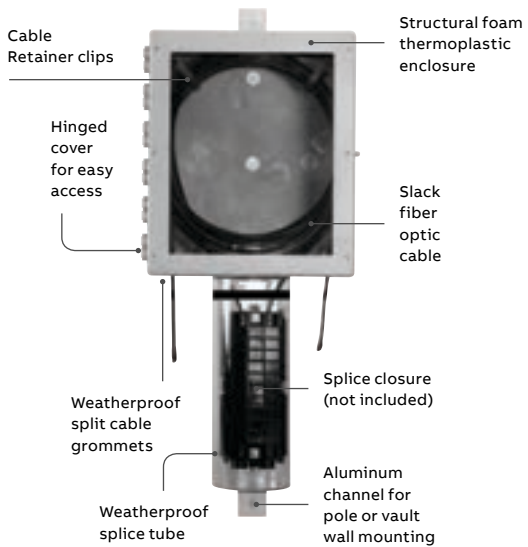

UL US LISTED E108856 LR31146

Cat. No.	Inside Box Size (in.)	Tube Size	Box Opening (in.)		Dimensions (in.)		
	A x B x C		E x F	K	M	N	
SPL111	30 x 24 x 11½	10	27¼ x 21¼	10¼	10½	1	
SPL122	30 x 24 x 9½	8	27¼ x 21¼	8¼	8½	1	
SPL211	24 x 20 x 11½	10	21¼ x 17¼	10¼	10½	1	
SPL222	24 x 20 x 9½	8	21¼ x 17¼	8¼	8½	1	

# Factory modifications

## For all enclosures

— 01 Painted JIC enclosure with painted back panel. Installed clear cover with handle and quick-release latch.

— 02 Color-molded JIC unit with addition of window and pushbuttons.

— 03 Molded junction box painted with addition of mounted weatherproof cover.

— 04 Painted JIC enclosure with pocket installed in cover for control pad.

### Color-molded enclosures

All Circuit Safe® enclosures can be molded in a variety of colors. Minimum quantities for single shipment or releases against blanket orders are required.

### Painted/silkscreened enclosures

All enclosures can be painted, interior and exterior, or by special request. Enclosure covers can also be silkscreened on request.

### EMI/RFI protection

For applications where Radio Frequency Interference is a factor, the interior can be coated with an acrylic base paint with a nickel filler. Windows can be covered with fine copper mesh.

### Other modifications available

Our factory is capable of modifying any of our enclosures to a customer's specifications. Factory's capabilities include:

- Precision milling of button holes, windows and pockets for keypad installations
- Hole tapping
- Ventilators
- Mounting bosses
- Access windows
- Hinged windows
- Mounted in-use weatherproof covers
- Handles for portable units
- Latches
- Enclosure coolers
- Cylinder locking systems
- And more...



01



02



03



04

# Enclosures for electrical equipment

## NEMA Types – definitions pertaining to non-hazardous locations

An enclosure is a surrounding case constructed to provide protection from accidental contact with the enclosed equipment and to provide protection to the enclosed equipment from specified environmental conditions. A brief description of the more common types of enclosures used by the electrical industry follows. For more information, see Table 110.28 of the National Electrical Code®.

**Type 1 enclosure:**

Intended for indoor use, primarily to provide protection against contact with enclosed equipment and a degree of protection against falling dirt.

**Type 2 enclosure:**

Intended for indoor use, primarily to provide a degree of protection against limited amounts of falling water and dirt.

**Type 3 enclosure:**

Intended for outdoor use, primarily to provide a degree of protection against wind-blown dust, rain, sleet and external ice formation.

**Type 3R enclosure:**

Intended for outdoor use, primarily to provide a degree of protection against falling rain, sleet and external ice formation.

**Type 3S enclosure:**

Intended for outdoor use, primarily to provide a degree of protection against wind-blown dust, rain and sleet, and to provide for operation of external mechanism when ice laden.

**Type 3X enclosure:**

Intended for outdoor use, primarily to provide a degree of protection against wind-blown dust, rain, sleet, external ice formation and corrosion.

**Type 3SX enclosure:**

Intended for outdoor use, primarily to provide a degree of protection against wind-blown dust, rain, sleet and corrosion, and to provide for operation of external mechanism when ice laden.

**Type 4 enclosure:**

Intended for indoor or outdoor use, primarily to provide a degree of protection against wind-blown dust and rain, splashing water and hose-directed water.

**Type 4X enclosure:**

Intended for indoor or outdoor use, primarily to provide a degree of protection against corrosion, wind-blown dust and rain, splashing water and hose-directed water.

**Type 6 enclosure:**

Intended for indoor or outdoor use, primarily to avoid a degree of protection against contact with enclosed equipment, falling dirt, hose-directed water, entry of water during occasional temporary submersion at a limited depth and external ice formation.

**Type 6P enclosure:**

Intended for indoor or outdoor use, primarily to provide a degree of protection against contact with enclosed equipment, falling dirt, hose-directed water, entry of water during prolonged submersion at a limited depth and external ice formation.

**Type 12 enclosure:**

Intended for indoor use, primarily to provide a degree of protection against dust, falling dirt and dripping non-corrosive liquids.

**Type 13 enclosure:**

Intended for indoor use, primarily to provide a degree of protection against dust, spraying of water, oil and non-corrosive coolant.

NEC and National Electrical Code are registered trademarks of the National Fire Protection Association, Inc.

# Index of ingress protection

## IEC 60529 IP Rating and NEMA 250 Enclosures







IP suitability ratings are a system for classifying the degree of protection provided by enclosures of electrical equipment.

### Protection against solid bodies

Degree of protection for persons against access to hazardous parts inside the enclosure and/or against the ingress of solid foreign objects.

### Protection against water

Degree of protection of equipment inside enclosures against damage from the ingress of water.

	<b>0</b>	No protection
	<b>1</b>	Objects greater than 50 mm, accidental touch by hands
	<b>2</b>	Objects greater than 12 mm, accidental touch by fingers
	<b>3</b>	Objects greater than 2.5 mm, e.g. tools/wires
	<b>4</b>	Objects greater than 1 mm, e.g. tools/wires/small wires
	<b>5</b>	Protected against dust - limited ingress (no harmful deposits)
	<b>6</b>	Totally protected against dust (Dust-tight)

	<b>0</b>	No protection
	<b>1</b>	Protected against vertically falling drops of water
	<b>2</b>	Protected against direct sprays of water 15° from vertical
	<b>3</b>	Protected against sprays of water to 60° from vertical
	<b>4</b>	Protected against water sprayed from all directions - limited ingress permitted
	<b>5</b>	Protected against low pressure jets of water from all directions - limited ingress permitted
	<b>6</b>	Protected against strong pressure jets of water, heavy seas - limited ingress permitted
	<b>7</b>	Protection against the effects of immersion between 15cm - 1 m
	<b>8</b>	Protection against long periods of immersion under a quoted pressure, e.g. 2 bar at 24 hours
	<b>9</b>	IP69 Automotive standard DIN40050 and signifies resistance to high pressure jets of water (up to 80bar) from any angle

**01 IP Ratings**  
The higher the number, the greater the degree of protection; they apply ONLY to properly installed equipment.

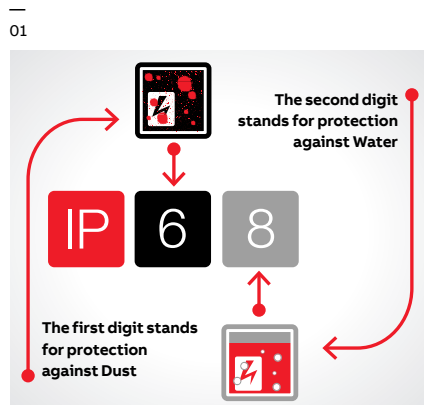

—  
**Conversion of NEMA enclosure type ratings to IEC 60529 enclosure Classification Designations (IP)**  
 (Cannot be used to convert Classification Designations to NEMA type ratings)

IP 1st Character	1		2		3, 3X, 3S, 3SX		3R, 3RX		4, 4X		5		6		6P		12, 12K, 13		IP 2nd Character
IP0_																			IP0_0
IP1_																			IP0_1
IP2_																			IP0_2
IP3_																			IP0_3
IP4_																			IP0_4
IP5_																			IP0_5
IP6_																			IP0_6
																			IP0_7
																			IP0_8
	A	B	A	B	A	B	A	B	A	B	A	B	A	B	A	B	A	B	

—  
**NEMA 250 to IEC 60529**

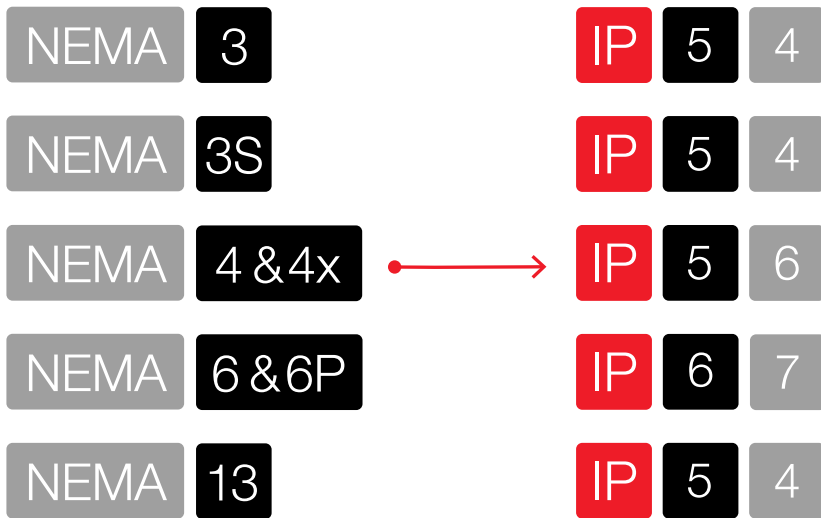

## Technical information

### Engineering properties of enclosures

Property	Test Method	Opaque Polycarbonate Covers & Boxes	Clear Polycarbonate Cover	FRP	NORYL
<b>Thermal and mechanical</b>					
Temperature Range (°F)	—	-30° to 230°	-30° to 230°	-58° to 320°	-40° to 185°
Specific Gravity (oz.in <sup>3</sup> )	ASTM D792	1.20	1.20	1.79	.85
Thermal Conductivity (BTU·in/hr·ft <sup>2</sup> ·°F)	ASTM D177	1.35	1.35	1.68	.86
Heat Deflection Temperature @ 264 PSI (°F)	ASTM D648	265	260	392	180
Tensile Strength (PSI)	ASTM D638	8,800	9,000	13,000	3,400
Flexural Strength (PSI)	ASTM D790	13,500	14,000	19,000	6,800
Compressive Strength @ 10% Deformation (PSI)	ASTM D695	12,500	12,500	24,000	5,200
Impact Strength IZOD Notched (ft.lbs./in.)	ASTM D256	12	12	12	—
Water Absorption – 24 hrs. @ 73°F (%)	ASTM D570	.15	.15	.17	.06
UV Rating	UL 746C	F1	F1	F2	—
<b>Electrical</b>					
Dielectric Strength (VOLTS/MIL.)	ASTM D149	380	380	467	192
Dielectric Constant	ASTM D150				
60 Hz			3.0	3.0	—
100 Hz			—	—	—
106 Hz			2.96	2.96	—
Volume Resistivity @ 73°F (OHM-CM)	ASTM D257	>10 <sup>16</sup>	>10 <sup>16</sup>	2.0 x 10 <sup>15</sup>	1.0 x 10 <sup>16</sup>
Arc Resistance (SEC)	ASTM D495	120	120	200+	67

### Clearance Holes for Carflex® Fittings or PVC Male Terminal Adapters

Carflex Fittings & PVC Male Terminal Adapters Trade Sizes	Nominal Size (in.)	Actual Size (in.)	Actual Size (mm)
½	.875	.879	22.4
¾	1.093	1.107	28.2
1	1.344	1.357	34.6
1¼	1.813	1.699	43.2
1½	1.938	1.949	49.6
2	2.375	2.413	61.5
2½	2.875	2.914	74.0
3	3.5	3.539	89.8
3½	4	4.044	102.7
4	4.5	4.544	115.4
5	5.625	5.675	143.7

# Technical information

## Environmental Resistance Table: E–Excellent, G–Good, L–Limited, U–Unsatisfactory

**Important:** These environmental resistance ratings are based upon tests where the specimens were replaced in complete submergence in the reagent listed. Ratings listed in this chart apply to a 48-hour exposure period. (The information in this chart is to be used ONLY as a guide in selecting equipment for appropriate chemical compatibility. Before permanent installation, test the equipment with the chemicals and under the specific conditions of your application.)

Chemical	Polycarbonate		FRP	
	Circuit Safe NEMA Circuit Safe JIC	(Fiberglass reinforced polyester)	Himeline HE clear cover w/ bases Himeline HP Himeline HLA/HLS Himeline HLP	Noryl Circuit Safe medium JIC
Acetaldehyde	U	L	—	—
Acetamide	U	U	—	—
Acetate Solvent	U	—	—	U
Acetic Acid	U	G	E	E
Acetic Acid 20%	U	E	E	E
Acetic Acid 80%	L	G	E	E
Acetic Acid, Glacial	U	G	E	E
Acetic Anhydride	U	U	E	U
Acetone	U	U	U	U
Acetyl Bromide	U	—	—	—
Acetyl Chloride (dry)	L	U	—	U
Acetylene	E	U	—	—
Acrylonitrile	G	U	—	—
Adipic Acid	E	—	—	—
Alcohols: Amyl	E	G	—	L
Alcohols: Benzyl	U	—	—	U
Alcohols: Butyl	E	E	—	E
Alcohols: Diacetone	G	—	—	E
Alcohols: Ethyl	L	G	—	E
Alcohols: Hexyl	E	—	—	E
Alcohols: Isobutyl	E	—	—	E
Alcohols: Isopropyl	E	E	—	E
Alcohols: Methyl	E	G	—	E
Alcohols: Octyl	—	—	—	E
Alcohols: Propyl	E	—	—	E
Aluminum Chloride	E	E	E	E
Aluminum Chloride 20%	E	E	—	E
Aluminum Fluoride	E	—	—	E
Aluminum Hydroxide	E	G	—	E
Aluminum Nitrate	G	E	—	—
Aluminum Potassium Sulfate 10%	E	E	—	E
Aluminum Potassium Sulfate 100%	E	E	—	E
Aluminum Sulfate	E	E	E	E
Amines	U	U	—	U
Ammonia 10%	G	U	—	E
Ammonia Nitrate	G	—	—	E
Ammonia, anhydrous	E	U	—	G
Ammonia, liquid	E	U	L	—
Ammonium Acetate	E	—	—	—
Ammonium Bifluoride	E	—	—	E
Ammonium Carbonate	E	—	L	E
Ammonium Caseinate	—	—	—	E
Ammonium Chloride	E	E	E	E
Ammonium Hydroxide	E	U	L	E
Ammonium Nitrate	E	—	L	E

Chemical	Polycarbonate		FRP	
	Circuit Safe NEMA Circuit Safe JIC	(Fiberglass reinforced polyester)	Himeline HE clear cover w/ bases Himeline HP Himeline HLA/HLS Himeline HLP	Noryl Circuit Safe medium JIC
Ammonium Oxalate	E	E	—	—
Ammonium Persulfate	E	—	—	E
Ammonium Phosphate, Dibasic	E	E	—	E
Ammonium Phosphate, Monobasic	E	—	—	E
Ammonium Phosphate, Tribasic	E	—	—	E
Ammonium Sulfate	E	E	E	E
Ammonium Sulfite	E	—	E	E
Amyl Acetate	U	U	L	U
Amyl Alcohol	E	G	L	L
Amyl Chloride	U	—	U	U
Aniline	L	U	U	U
Aniline Hydrochloride	G	U	—	—
Antifreeze	E	—	—	E
Antimony Trichloride	E	E	E	E
Aqua Regia (80% HCl, 20% HNO <sub>3</sub> )	L	U	—	U
Aromatic Hydrocarbons	U	—	—	U
Arsenic Acid	E	E	—	E
Arsenic Salts	E	—	—	—
Asphalt	E	U	—	—
Barium Carbonate	E	E	E	E
Barium Chloride	E	E	E	E
Barium Cyanide	U	—	—	—
Barium Hydroxide	E	U	U	E
Barium Nitrate	E	U	—	E
Barium Sulfate	G	U	E	E
Barium Sulfide	E	—	E	E
Beer	E	E	—	E
Beet Sugar Liquids	E	—	—	E
Benzaldehyde	U	U	U	G
Benzene	L	U	L	U
Benzene Sulfonic Acid	E	U	E	E
Benzoic Acid	E	G	—	G
Benzol	—	U	—	G
Benzonitrile	—	E	—	—
Benzyl Chloride	—	—	—	U
Bleaching Liquors	E	—	—	—
Borax (Sodium Borate)	E	—	—	E
Boric Acid	E	—	E	E
Bromine	L	L	—	E
Butadiene	L	U	—	U
Butane	L	U	—	U
Butanol (Butyl Alcohol)	L	G	—	E
Butyl Amine	U	U	—	U
Butyl Ether	E	—	—	U
Butyl Phthalate	—	U	—	E

## Technical information

### Environmental Resistance Table: E–Excellent, G–Good, L–Limited, U–Unsatisfactory

**Important:** These environmental resistance ratings are based upon tests where the specimens were replaced in complete submergence in the reagent listed. Ratings listed in this chart apply to a 48-hour exposure period. (The information in this chart is to be used ONLY as a guide in selecting equipment for appropriate chemical compatibility. Before permanent installation, test the equipment with the chemicals and under the specific conditions of your application.)

Chemical	Polycarbonate		FRP		Noryl
	Circuit Safe	(Fiberglass Reinforced Polyester)	Circuit Safe	(Fiberglass Reinforced Polyester)	
	PVC Himeline HE	Clear Cover w/ Bases	HP Himeline HLA/HLS Himeline HLP	Safe Medium JIC	
Butylacetate	U	U	U	U	G
Butylene	E	U	—	—	—
Butyric Acid	G	U	—	U	—
Calcium Bisulfate	—	U	—	—	—
Calcium Bisulfide	E	—	—	E	—
Calcium Bisulfite	G	U	—	E	—
Calcium Carbonate	E	L	E	E	—
Calcium Chlorate	G	—	E	—	—
Calcium Chloride	L	—	E	E	—
Calcium Hydroxide	G	U	U	E	—
Calcium Hypochlorite	G	U	L	E	—
Calcium Nitrate	E	E	E	E	—
Calcium Oxide	G	—	—	E	—
Calcium Sulfate	G	E	E	E	—
Calgon	—	—	—	E	—
Cane Juice	E	—	—	—	—
Carbolic Acid (Phenol)	U	U	—	U	—
Carbon Bisulfide	U	—	L	—	—
Carbon Dioxide (dry)	E	—	—	E	—
Carbon Dioxide (wet)	E	—	—	E	—
Carbon Disulfide	U	U	—	U	—
Carbon Monoxide	E	—	—	E	—
Carbon Tetrachloride	U	U	E	U	—
Carbon Tetrachloride (dry)	—	—	—	U	—
Carbon Tetrachloride (wet)	—	—	—	U	—
Carbon Disulfide	U	U	—	U	—
Carbon Monoxide	E	—	—	E	—
Carbon Tetrachloride	U	U	E	U	—
Carbon Tetrachloride (dry)	—	—	—	U	—
Carbon Tetrachloride (wet)	—	—	—	U	—
Carbonated Water	E	—	—	E	—
Carbonic Acid	E	E	—	E	—
Catsup	E	—	—	E	—
Chloric Acid	E	—	—	U	—
Chlorine (dry)	U	—	—	G	—
Chlorine Water	E	—	E	L	—
Chlorine, Anhydrous Liquid	U	L	—	G	—
Chloroacetic Acid	G	U	—	—	—
Chlorobenzene (Mono)	U	U	U	U	—
Chlorobromomethane	U	—	—	—	—
Chloroform	U	U	—	U	—
Chlorosulfonic Acid	U	L	—	U	—
Chocolate Syrup	—	E	—	E	—
Chromic Acid 10%	E	G	E	E	—
Chromic Acid 30%	E	L	—	U	—

Chemical	Polycarbonate		FRP		Noryl
	Circuit Safe	(Fiberglass Reinforced Polyester)	Circuit Safe	(Fiberglass Reinforced Polyester)	
	PVC Himeline HE	Clear Cover w/ Bases	HP Himeline HLA/HLS Himeline HLP	Safe Medium JIC	
Chromic Acid 5%	E	G	—	E	—
Chromic Acid 50%	U	U	—	U	—
Chromium Salts	E	—	—	—	—
Citric Acid	G	E	E	E	—
Citric Oils	—	—	—	E	—
Clorox® (Bleach)	E	—	—	E	—
Copper Chloride	E	—	—	E	—
Copper Cyanide	E	U	—	E	—
Copper Fluoborate	E	—	—	—	—
Copper Nitrate	E	U	—	E	—
Copper Sulfate >5%	E	E	—	E	—
Copper Sulfate 5%	E	E	—	E	—
Cresols	U	U	U	U	—
Cresylic Acid	U	U	—	—	—
Cupric Acid	E	E	—	E	—
Cyclohexane	U	G	—	U	—
Cyclohexanone	U	U	—	U	—
Detergents	E	E	—	E	—
Diacetone Alcohol	U	U	—	—	—
Dichlorobenzene	U	U	—	—	—
Dichloroethane	U	U	—	E	—
Diesel Fuel	E	E	—	U	—
Diethyl Ether	U	U	—	—	—
Diethylamine	U	U	—	—	—
Diethylene Glycol	L	G	—	E	—
Dimethyl Aniline	U	U	U	U	—
Dimethyl Formamide	U	U	—	U	—
Diphenyl Oxide	U	—	—	—	—
Dyes	G	—	—	E	—
Epsom Salts (Magnesium Sulfate)	E	E	—	E	—
Ethane	E	—	—	—	—
Ethanol	L	G	—	E	—
Ethanolamine	U	—	—	E	—
Ether	U	—	L	U	—
Ethyl Acetate	U	U	L	E	—
Ethyl Benzoate	U	U	—	E	—
Ethyl Chloride	U	U	L	U	—
Ethyl Ether	U	—	U	U	—
Ethylene Bromide	U	U	—	—	—
Ethylene Chloride	U	U	—	U	—
Ethylene Chlorohydrin	U	U	E	—	—
Ethylene Diamine	U	E	—	U	—
Ethylene Dichloride	U	U	U	U	—
Ethylene Glycol	E	G	E	E	—
Ethylene Oxide	U	L	—	E	—

# Technical information

## Environmental Resistance Table: E–Excellent, G–Good, L–Limited, U–Unsatisfactory

**Important:** These environmental resistance ratings are based upon tests where the specimens were placed in complete submergence in the reagent listed. Ratings listed in this chart apply to a 48-hour exposure period. (The information in this chart is to be used ONLY as a guide in selecting equipment for appropriate chemical compatibility. Before permanent installation, test the equipment with the chemicals and under the specific conditions of your application.)

Chemical	Polycarbonate		FRP		Noryl
	Circuit Safe NEMA Circuit Safe JIC	(Fiberglass Reinforced Polyester)	Circuit Safe NEMA Circuit Safe JIC	(Fiberglass Reinforced Polyester)	
	Himeline HE Opaque Cover w/Base	Himeline HE Clear Cover w/ Bases Himeline HP Himeline HLA/HLS Himeline HLP	Himeline HS – Bases Himeline HP Himeline HLA/HLS Himeline HLP	Himeline HS – Bases Himeline HP Himeline HLA/HLS Himeline HLP	Circuit Safe Medium JIC
Fatty Acids	E	G	—	—	E
Ferric Chloride	E	E	E	E	E
Ferric Nitrate	E	E	E	E	E
Ferric Sulfate	E	E	E	E	E
Ferrous Chloride	E	U	E	E	E
Ferrous Sulfate	E	E	E	E	E
Fluoboric Acid	E	—	—	—	E
Fluorine	U	L	—	—	—
Fluosilicic Acid	U	E	—	—	E
Formaldehyde 100%	E	E	—	—	E
Formaldehyde 40%	E	E	E	E	E
Formic Acid	E	E	L	E	E
Freon 113	G	G	—	—	U
Freon 12	E	—	—	—	U
Freon 22	E	—	—	—	G
Freon TF	G	—	—	—	—
Freon® 11	E	—	—	—	G
Fuel Oils	E	G	—	—	G
Furan Resin	E	—	—	—	—
Furfural	U	U	L	U	U
Gallic Acid	G	—	—	—	E
Gasoline (high-aromatic)	E	E	—	—	G
Gasoline, leaded, ref.	G	E	E	E	G
Gasoline, unleaded	L	E	—	—	U
Gelatin	G	—	—	—	E
Glucose	E	E	E	E	E
Glue, P.V.A.	L	—	—	—	—
Glycerin	E	E	E	E	E
Glycolic Acid	G	—	—	—	—
Grease	E	—	—	—	—
Heptane	L	G	E	G	G
Hexane	G	U	U	G	G
Hydraulic Oil (Petro)	E	—	—	—	—
Hydraulic Oil (Synthetic)	E	—	—	—	—
Hydrazine	—	U	—	—	—
Hydrobromic Acid 100%	E	—	—	—	G
Hydrobromic Acid 20%	G	—	—	—	G
Hydrochloric Acid 100%	U	U	—	—	E
Hydrochloric Acid 20%	E	G	E	E	E
Hydrochloric Acid 37%	G	U	L	E	E
Hydrochloric Acid, Dry Gas	E	—	—	—	E
Hydrocyanic Acid	G	—	—	—	E
Hydrocyanic Acid (Gas 10%)	E	G	—	—	L
Hydrofluoric Acid 100%	L	U	—	—	U
Hydrofluoric Acid 20%	G	U	—	—	L

Chemical	Polycarbonate		FRP		Noryl
	Circuit Safe NEMA Circuit Safe JIC	(Fiberglass Reinforced Polyester)	Circuit Safe NEMA Circuit Safe JIC	(Fiberglass Reinforced Polyester)	
	Himeline HE Opaque Cover w/Base	Himeline HE Clear Cover w/ Bases Himeline HP Himeline HLA/HLS Himeline HLP	Himeline HS – Bases Himeline HP Himeline HLA/HLS Himeline HLP	Himeline HS – Bases Himeline HP Himeline HLA/HLS Himeline HLP	Circuit Safe Medium JIC
Hydrofluoric Acid 50%	G	U	—	—	U
Hydrofluoric Acid 75%	L	U	—	—	U
Hydrofluosilicic Acid 100%	G	—	—	—	G
Hydrofluosilicic Acid 20%	E	—	—	—	G
Hydrogen Gas	E	E	—	—	E
Hydrogen Peroxide 10%	E	E	—	—	E
Hydrogen Peroxide 100%	E	E	—	—	E
Hydrogen Peroxide 30%	E	E	E	E	E
Hydrogen Peroxide 50%	E	E	E	—	—
Hydrogen Sulfide (aqua)	G	E	—	—	E
Hydrogen Sulfide (dry)	E	—	—	—	—
Hydroquinone	G	—	—	—	—
Hydroxyacetic Acid 70%	U	—	—	—	—
Ink	L	—	—	—	—
Iodine	E	—	—	—	L
Iodine (in alcohol)	E	—	—	—	—
Iodoform	E	—	—	—	—
Isooctane	E	G	—	—	U
Isopropyl Acetate	U	U	—	—	—
Isopropyl Ether	G	U	—	—	—
Isotane	E	—	—	—	—
Jet Fuel (JP3, JP4, JP5)	L	E	—	—	U
Kerosene	E	U	—	—	U
Ketones	U	U	—	—	U
Lacquer Thinners	U	G	—	—	U
Lacquers	U	U	—	—	U
Lactic Acid	G	G	E	E	E
Lard	E	E	—	—	E
Lead Acetate	G	—	—	—	E
Lead Nitrate	E	—	—	—	E
Lead Sulfamate	G	E	—	—	—
Lime	G	—	—	—	—
Linoleic Acid	E	—	—	—	—
Lithium Chloride	U	G	—	—	—
Lithium Hydroxide	—	U	—	—	—
Lubricants	G	E	—	—	L
Lye: Ca(OH) <sub>2</sub> Calcium Hydroxide	G	U	—	—	E
Lye: KOH Potassium Hydroxide	G	U	—	—	E
Lye: NaOH Sodium Hydroxide	E	U	—	—	E
Epsom Salts (Magnesium Sulfate)	E	E	—	—	E
Magnesium Bisulfate	E	E	—	—	—
Magnesium Carbonate	G	E	E	E	E
Magnesium Chloride	G	E	E	E	E
Magnesium Hydroxide	E	E	G	E	E
Magnesium Nitrate	E	E	—	—	E

## Technical Information

### Environmental Resistance Table: E–Excellent, G–Good, L–Limited, U–Unsatisfactory

**Important:** These environmental resistance ratings are based upon tests where the specimens were replaced in complete submergence in the reagent listed. Ratings listed in this chart apply to a 48-hour exposure period. (The information in this chart is to be used ONLY as a guide in selecting equipment for appropriate chemical compatibility. Before permanent installation, test the equipment with the chemicals and under the specific conditions of your application.)

Chemical	Polycarbonate		FRP	
	Circuit Safe NEMA Circuit Safe JIC	(Fiberglass reinforced polyester)	Himeline HE clear cover w/ base Himeline HS opaque w/clear lids	Himeline HS – Bases Himeline HP Himeline HLA/HLS Himeline HLP
Magnesium Oxide	—	—	—	—
Magnesium Sulfate (Epsom Salts)	E	E	E	E
Maleic Acid	E	—	—	E
Malic Acid	E	—	—	—
Manganese Sulfate	L	E	—	E
Mayonnaise	U	—	—	—
Melamine	U	—	—	—
Mercuric Chloride (dilute)	E	E	—	E
Mercuric Cyanide	E	—	—	—
Mercurous Nitrate	E	E	—	E
Mercury	E	U	—	E
Methane	G	—	—	—
Methanol (Methyl Alcohol)	E	G	L	E
Methyl Acetate	U	U	—	—
Methyl Acetone	U	—	—	—
Methyl Alcohol 10%	E	G	—	E
Methyl Bromide	U	—	—	—
Methyl Butyl Ketone	E	U	—	—
Methyl Cellosolve	U	U	—	—
Methyl Chloride	U	U	—	U
Methyl Dichloride	E	—	—	—
Methyl Ethyl Ketone	U	U	E	U
Methyl Isobutyl Ketone	U	U	—	U
Methyl Isopropyl Ketone	U	U	—	U
Methyl Methacrylate	E	—	—	—
Methylamine	U	—	—	—
Methylene Chloride	U	U	U	U
Mineral Spirits	E	L	—	E
Monochloroacetic acid	—	U	—	—
Monoethanolamine	U	—	—	E
Morpholine	—	U	—	U
Motor oil	G	E	—	E
Naphtha	E	G	E	U
Naphthalene	U	—	—	U
Natural Gas	E	—	—	—
Nickel Chloride	E	E	—	E
Nickel Nitrate	E	U	—	E
Nickel Sulfate	E	E	—	E
Nitrating Acid (<15% HNO <sub>3</sub> )	U	—	—	—
Nitrating Acid (>15% H <sub>2</sub> SO <sub>4</sub> )	U	—	—	—
Nitrating Acid (_1% Acid)	U	—	—	—
Nitrating Acid (_15% H <sub>2</sub> SO <sub>4</sub> )	U	—	—	—
Nitric Acid (20%)	E	G	G	G
Nitric Acid (50%)	G	G	—	G
Nitric Acid (50%)	G	G	—	G

Chemical	Polycarbonate		FRP	
	Circuit Safe NEMA Circuit Safe JIC	(Fiberglass reinforced polyester)	Himeline HE clear cover w/ base Himeline HS opaque w/clear lids	Himeline HS – Bases Himeline HP Himeline HLA/HLS Himeline HLP
Nitric Acid (5–10%)	E	E	—	E
Nitric Acid (Concentrated)	G	L	—	G
Nitrobenzene	U	U	L	U
Nitromethane	G	U	—	U
Nitrous Acid	E	—	—	—
Nitrous Oxide	E	—	—	—
Oil: Aniline	U	—	—	U
Oil: Citric	G	E	—	E
Oil: Creosote	L	—	—	U
Oil: Diesel Fuel (20, 30, 40, 50)	G	—	—	U
Oil: Diesel Fuel (20, 30, 40, 50)	G	—	—	U
Oil: Hydraulic Oil (Petro)	E	—	—	—
Oil: Hydraulic Oil (Synthetic)	E	—	—	—
Oil: Mineral	G	G	—	E
Oil: Olive	L	E	—	E
Oil: Orange	L	L	—	—
Oil: Pine	U	E	—	—
Oil: Rosin	L	—	—	—
Oil: Silicone	E	—	—	E
Oil: Transformer	G	—	—	—
Oil: Turbine	E	—	—	—
Oleic Acid	L	—	E	E
Oleum 100%	U	—	—	E
Oleum 25%	U	—	—	—
Oxalic Acid (cold)	G	—	E	E
Ozone	G	E	—	—
Palmitic Acid	G	—	—	—
Paraffin	G	E	—	E
Pentane	E	E	—	—
Perchloric Acid	L	—	—	—
Perchloroethylene	L	U	—	U
Petrolatum	G	—	—	—
Petroleum	—	—	—	U
Phenol (10%)	L	G	L	U
Phenol (Carbolic Acid)	U	U	—	U
Phosphoric Acid (>40%)	G	E	—	E
Phosphoric Acid (crude)	G	E	—	E
Phosphoric Acid (molten)	U	—	—	—
Phosphoric Acid (_40%)	G	E	—	E
Phosphoric Acid Anhydride	—	U	—	—
Phosphorus	E	—	—	—
Phosphorus Trichloride	U	L	—	—
Photographic Developer	E	E	—	E
Photographic Solutions	E	E	—	E
Phthalic Anhydride	U	E	—	—

# Technical Information

## Environmental Resistance Table: E–Excellent, G–Good, L–Limited, U–Unsatisfactory

**Important:** These environmental resistance ratings are based upon tests where the specimens were placed in complete submergence in the reagent listed. Ratings listed in this chart apply to a 48-hour exposure period. (The information in this chart is to be used ONLY as a guide in selecting equipment for appropriate chemical compatibility. Before permanent installation, test the equipment with the chemicals and under the specific conditions of your application.)

Chemical	Polycarbonate		FRP	
	Circuit Safe NEMA Circuit Safe JIC	(Fiberglass reinforced polyester)	Himeline HE clear cover w/ bases Himeline HP Himeline HLA/HLS Himeline HLP	Noryl Circuit Safe medium JIC
Picric Acid	U	U	—	—
Potash (Potassium Carbonate)	E	—	L	E
Potassium Bicarbonate	E	—	—	E
Potassium Bromide	E	E	—	E
Potassium Chlorate	E	E	—	E
Potassium Chloride	E	E	E	E
Potassium Chromate	E	—	E	E
Potassium Cyanide Solutions	E	—	—	E
Potassium Dichromate	E	E	—	E
Potassium Ferricyanide	E	—	E	E
Potassium Ferrocyanide	E	—	E	E
Potassium Hydroxide (Caustic Potash)	E	U	L	E
Potassium Hypochlorite	G	—	—	—
Potassium Iodide	E	—	—	—
Potassium Nitrate	E	E	E	E
Potassium Oxalate	—	—	—	—
Potassium Permanganate	E	E	E	E
Potassium Sulfate	E	E	E	E
Potassium Sulfide	E	—	—	E
Propane (liquefied)	E	L	—	E
Propylene	G	—	—	—
Propylene Glycol	L	G	—	—
Pyridine	U	U	—	G
Pyrogalllic Acid	E	—	—	—
Resorcinol	L	G	—	—
Rosins	L	—	—	—
Salicylic Acid	G	E	—	—
Salt Brine (NaCl saturated)	E	E	—	E
Sea Water	E	E	—	E
Silicone	E	E	—	E
Silver Bromide	—	—	—	E
Silver Nitrate	E	E	—	E
Soap Solutions	E	E	—	E
Soda Ash (see Sodium Carbonate)	E	E	—	E
Sodium Acetate	G	E	E	E
Sodium Aluminate	—	—	—	E
Sodium Benzoate	G	E	—	—
Sodium Bicarbonate	E	E	E	E
Sodium Bisulfate	E	E	—	E
Sodium Bisulfite	E	E	—	E
Sodium Borate (Borax)	E	E	—	E
Sodium Bromide	G	—	E	E
Sodium Carbonate	E	E	—	E
Sodium Chlorate	E	E	E	E
Sodium Chloride	E	E	E	E

Chemical	Polycarbonate		FRP	
	Circuit Safe NEMA Circuit Safe JIC	(Fiberglass reinforced polyester)	Himeline HE clear cover w/ bases Himeline HP Himeline HLA/HLS Himeline HLP	Noryl Circuit Safe medium JIC
Sodium Chromate	—	E	—	E
Sodium Cyanide	E	—	—	E
Sodium Ferrocyanide	E	—	E	E
Sodium Fluoride	E	—	—	E
Sodium Hydrosulfite	L	—	—	—
Sodium Hydroxide (20%)	E	E	U	E
Sodium Hydroxide (50%)	E	U	U	E
Sodium Hydroxide (80%)	E	U	U	E
Sodium Hypochlorite (<20%)	E	L	L	E
Sodium Hypochlorite (100%)	G	—	—	E
Sodium Metaphosphate	E	—	—	—
Sodium Metasilicate	E	—	—	—
Sodium Nitrate	E	—	U	E
Sodium Perborate	E	—	—	E
Sodium Peroxide	G	E	—	—
Sodium Polyphosphate	E	—	—	E
Sodium Silicate	E	—	—	E
Sodium Sulfate	E	E	E	E
Sodium Sulfide	E	U	U	E
Sodium Sulfite	E	—	E	E
Sodium Tetraborate	E	—	—	E
Sodium Thiosulfate (hypo)	E	U	—	E
Stannic Chloride	E	E	—	E
Stannic Fluoborate	—	—	—	E
Stannous Chloride	E	—	—	E
Stearic Acid	G	E	—	E
Stoddard Solvent	L	E	—	U
Styrene	U	U	—	E
Sulfate (Liquors)	G	—	—	—
Sulfur Chloride	L	—	—	E
Sulfur Dioxide	E	—	—	E
Sulfur Dioxide (dry)	E	E	—	E
Sulfur Hexafluoride	G	—	—	—
Sulfur Trioxide	E	—	—	U
Sulfur Trioxide (dry)	E	—	—	U
Sulfuric Acid (<10%)	E	E	E	E
Sulfuric Acid (10–75%)	E	G	U	E
Sulfuric Acid (75–100%)	U	U	—	E
Sulfuric Acid (cold concentrated)	U	—	—	E
Sulfuric Acid (hot concentrated)	U	U	—	U
Sulfurous Acid	E	—	—	E
Tallow	—	—	—	E
Tannic Acid	E	L	—	E
Tanning Liquors	E	—	—	E
Tartaric Acid	E	—	E	E

## Technical information

### Environmental Resistance Table: E–Excellent, G–Good, L–Limited, U–Unsatisfactory

**Important:** These environmental resistance ratings are based upon tests where the specimens were replaced in complete submergence in the reagent listed. Ratings listed in this chart apply to a 48-hour exposure period. (The information in this chart is to be used ONLY as a guide in selecting equipment for appropriate chemical compatibility. Before permanent installation, test the equipment with the chemicals and under the specific conditions of your application.)

Chemical	Polycarbonate		FRP	
	Circuit Safe NEMA Circuit Safe JIC	(Fiberglass reinforced polyester)	Himeline HE clear cover w/ bases Himeline HP Himeline HLA/HLS Himeline HLP	Noryl Circuit Safe medium JIC
Tetrachloroethane	L	—	—	U
Tetrachloroethylene	U	U	—	U
Tetrahydrofuran	U	U	L	U
Tin Salts	E	—	—	—
Toluene (Toluol)	U	U	—	U
Trichloroacetic Acid	G	U	—	—
Trichloroethane	L	U	—	U
Trichloroethylene	U	—	U	U
Trichloropropane	—	—	—	U
Tricresylphosphate	U	—	—	E
Triethylamine	G	—	—	G
Trisodium Phosphate	E	—	—	E
Turpentine	U	U	E	U
Urea	U	U	L	E
Uric Acid	E	—	—	—
Varnish	U	—	—	U

Chemical	Polycarbonate		FRP	
	Circuit Safe NEMA Circuit Safe JIC	(Fiberglass reinforced polyester)	Himeline HE clear cover w/ bases Himeline HP Himeline HLA/HLS Himeline HLP	Noryl Circuit Safe medium JIC
Vinegar	G	E	E	E
Vinyl Acetate	U	—	—	—
Vinyl Chloride	U	—	—	—
Water, Acid, Mine	G	G	—	—
Water, Deionized	E	—	—	E
Water, Distilled	E	E	—	E
Beet Sugar Liquids	E	—	—	E
Water, Fresh	G	E	—	E
Water, Salt	G	E	—	E
Whiskey & Wines	E	E	—	E
White Liquor (Pulp Mill)	E	—	—	E
White Water (Paper Mill)	E	—	—	U
Xylene	U	U	E	G
Zinc Chloride	G	E	E	E
Zinc Hydrosulfite	—	—	—	E
Zinc Sulfate	E	E	E	E



**Additional information**

We reserve the right to make technical changes or modify the contents of this document without prior notice. With regard to purchase orders, the agreed particulars shall prevail. ABB AG does not accept any responsibility whatsoever for potential errors or possible lack of information in this document.

We reserve all rights in this document and in the subject matter and illustrations contained therein. Any reproduction, disclosure to third parties or utilisation of its contents – in whole or in parts – is forbidden without prior written consent of ABB AG.





—  
**US**

ABB Installation Products  
Electrification Products division  
860 Ridge Lake Blvd.  
Memphis, TN 38120  
+1 901-252-5000

**[tnb.abb.com](http://tnb.abb.com)**

—  
**Canada**

ABB Installation Products  
Electrification Products division  
700 Thomas Avenue  
Saint-Jean-sur-Richelieu  
Quebec, J2X 2M9  
+1 450-347-5318

**[tnb.ca.abb.com](http://tnb.ca.abb.com)**