

REVISIONS			
REV.	DESCRIPTION	DATE	APPROVED
A	REDRAWN IN SW	6/1/2005	

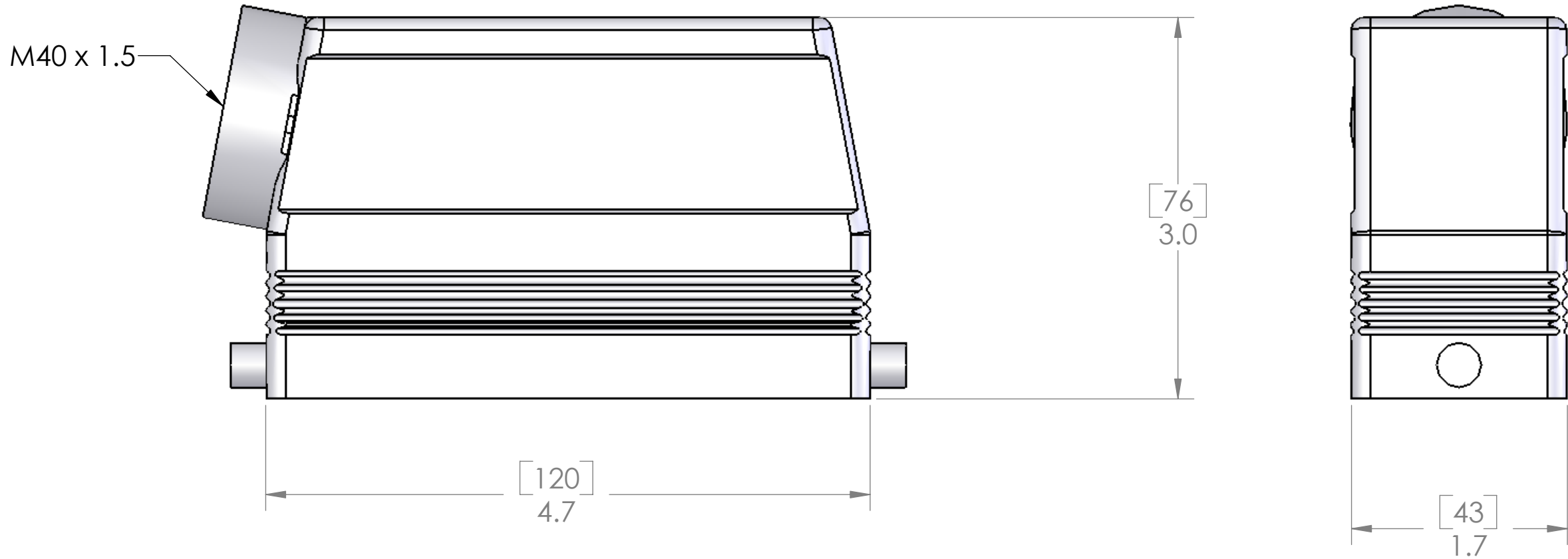

HOUSING MATERIALS	
BODY:	EPOXY COATED DIE CAST ALUMINUM

UNLESS OTHERWISE SPECIFIED: DIMENSIONS ARE IN INCHES AND [MM]	NAME	DWM
	DRAWN	
	CHECKED	
	ENG APPR.	
	MFG APPR.	
MATERIAL	COMMENTS:	
FINISH		
DO NOT SCALE DRAWING		

MENCOM CORPORATION		
TITLE:		
SIZE	DWG. NO.	REV
B	MAO-24L40	A
SCALE: 1:1	WEIGHT:	SHEET 1 OF 1

SEAL RATING OF IP 65 ONLY ACHIEVED WHEN FULLY LATCHED TO MATING BASE AND WITH AN APPROPRIATE SEALING GLAND INSTALLED

PROPRIETARY AND CONFIDENTIAL
THE INFORMATION CONTAINED IN THIS DRAWING IS THE SOLE PROPERTY OF MENCOM CORPORATION. ANY REPRODUCTION IN PART OR AS A WHOLE WITHOUT THE WRITTEN PERMISSION OF MENCOM CORPORATION IS PROHIBITED.