

FRONT VIEW

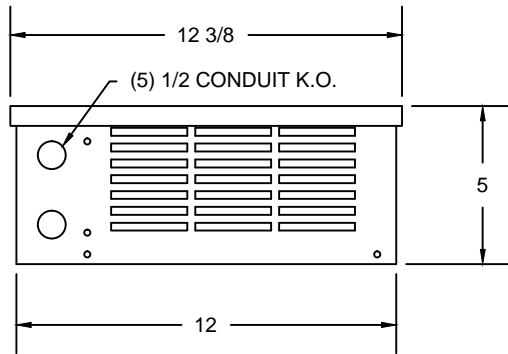

SIDE VIEW

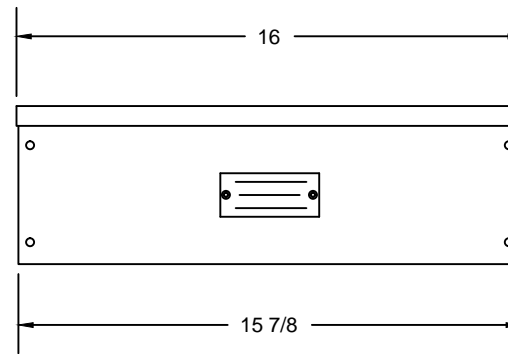

BOTTOM VIEW

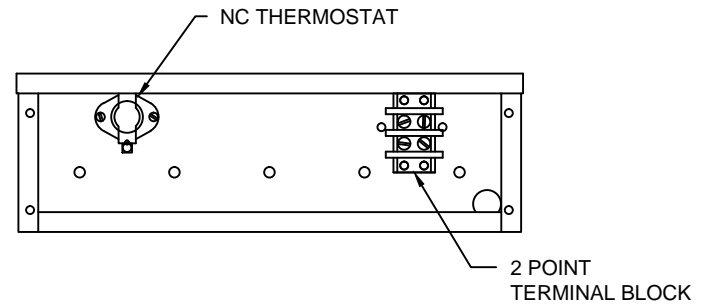
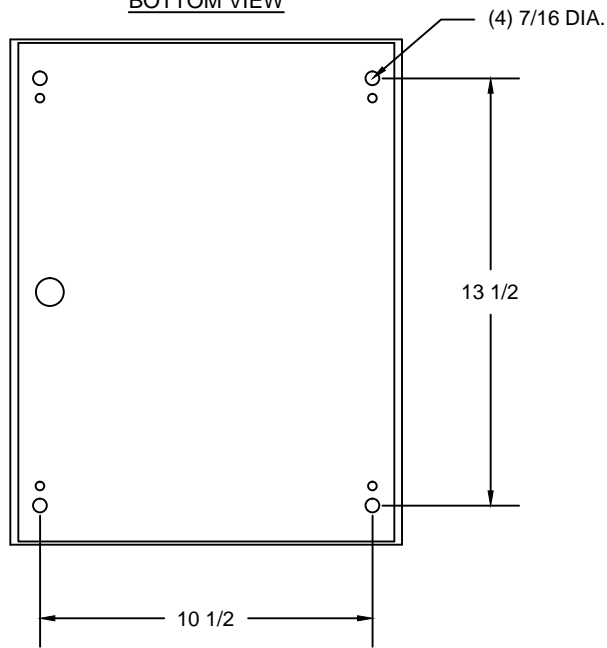

GENERAL NOTES:

- A. ALL DIMENSIONS ARE IN INCHES.
- B. FINISH: MILL GALVANIZED



5713 13TH STREET
KATY, TEXAS 77493
PHONE: (800) 838-4694

TEXT			
GCE ENCLOSURE: SIZE 5			
DWG. NO.	REV.	SHEET	
GCE5	0	1 of 1	
DRAWN BY	CHCK'D BY	DATE	SIZE
RAO		00/00/00	A