

# POWR-SPEED® Fuse

## PSR SERIES HIGH-SPEED SQUARE BODY

Semiconductor Fuses • Bolted Blade • 40 A–2250 A



### Description

Littelfuse PSR series high-speed square body fuses are specially designed for protection of power semiconductor devices such as diodes, triacs, IGBTs, SCRs, MOSFETs, and other solid-state devices that are typically designed into power conversion and power conditioning equipment. Variable frequency drives, inverters, UPS, rectifiers, and soft-starters are examples of typical equipment designed with sensitive power semiconductor devices that cannot withstand any line surge or overcurrent conditions and require high-speed protection.

The PSR series with bolted blades is designed and tested to IEC 60269-4.

Littelfuse POWR-SPEED® PSR series products offer optimized circuit protection at the extremely fast speed required to protect modern day power conversion devices. Available in bolted blade style termination (typical in North American market) with visual blown fuse indication standard on all fuses and optional micro-switch for external indication.

### Features/Benefits

- Best in class dc performance
- Extremely current limiting
- Superior cycling capability
- Visual and optional microswitch fuse blown indication
- Low watt-loss design
- Compliance with US and Canadian requirements
- Fast-acting Class aR performance

### Applications

- Power conversion devices (UPS, inverter, rectifiers, drives)
- Dc systems (dc common bus, dc injection braking)
- Battery protection application (energy storage systems)
- Electric vehicle charging stations
- Heaters and power supplies

### Specifications

<b>Voltage Rating</b>	Ac: 450 V–1300 V Dc: 450 V–1000 V
<b>Amperage Rating</b>	40 A–2250 A
<b>Interrupting Rating</b>	Ac: 100 kA–200 kA Dc: 150 kA
<b>Time Constant</b>	10 ms at IR
<b>Microswitch</b>	Yes
<b>Mounting</b>	Bolted blade style
<b>Material</b>	Body: ceramic Contacts: plated copper
<b>Approvals</b>	UL 248-13 Recognized (File: E71611) cURus (File: E71611)
<b>Environmental</b>	RoHS Compliant, REACH
<b>Operating Temperature</b>	-55 °C to +125 °C
<b>Storage Temperature</b>	Up to +35 °C with relative humidity <65 %
<b>Country of Origin</b>	Mexico

### Ordering Part Number

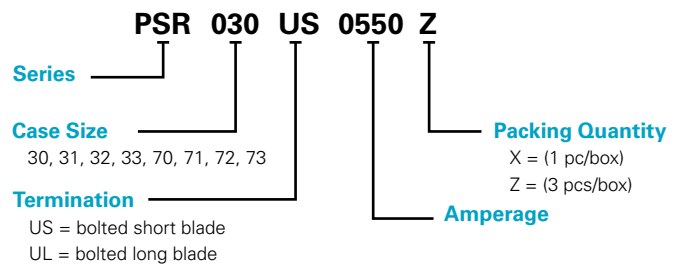

### Catalog Number

SERIES	CASE SIZE	TERMINATION	AMPERAGE	CATALOG NUMBER	ORDERING PART NUMBER
PSR	030	US	0550	PSR030US0550	PSR030US0550Z

### Recommended Accessories

**Microswitch:** MS3H1000C (Case Size 30 to 33)  
MS7H1500C (Case Size 70 to 73)

### Web Resources

Download technical documents: [Littelfuse.com/PSR](http://Littelfuse.com/PSR)  
*Note: high-speed fuses are designed for fixed installations. They are not intended for use in moving vehicle applications.*

# POWR-SPEED® Fuse

## PSR SERIES HIGH-SPEED SQUARE BODY

### Electrical Characteristics

CASE SIZE	CATALOG NUMBER		AMPERE RATING (A)	VOLTAGE RATING (V)			INTERRUPTING RATING		MELTING (PRE-ARC) I <sup>2</sup> T (A <sup>2</sup> S)	TOTAL CLEARING I <sup>2</sup> T (A <sup>2</sup> S) AT RATED VOLTAGE		WATT LOSS AT 100 % RATED CURRENT (W)	AGENCY CERTIFICATION
	BOLTED SHORT BLADE (US)	BOLTED LONG BLADE (UL)		AC		DC	AC	DC		AC	DC		
				IEC*	UL								
30	PSR030US0040	PSR030UL0040	40	690	700	600	200 kA	150 kA	76	280	260	13	•
	PSR030US0050	PSR030UL0050	50	690	700	600	200 kA	150 kA	110	598	384	16	•
	PSR030US0063	PSR030UL0063	63	690	700	600	200 kA	150 kA	176	1023	640	20	•
	PSR030US0080	PSR030UL0080	80	690	700	600	200 kA	150 kA	304	1728	1252	24	•
	PSR030US0100	PSR030UL0100	100	690	700	600	200 kA	150 kA	437	2835	1575	28	•
	PSR030US0125	PSR030UL0125	125	690	700	600	200 kA	150 kA	707	4684	2783	37	•
	PSR030US0160	PSR030UL0160	160	690	700	600	200 kA	150 kA	1359	9114	5507	40	•
	PSR030US0200	PSR030UL0200	200	690	700	600	200 kA	150 kA	3012	15169	14700	40	•
	PSR030US0250	PSR030UL0250	250	690	700	600	200 kA	150 kA	4668	29952	20833	52	•
	PSR030US0315	PSR030UL0315	315	690	700	600	200 kA	150 kA	7131	61830	31600	64	•
	PSR030US0350	PSR030UL0350	350	690	700	600	200 kA	150 kA	12007	85320	49273	66	•
	PSR030US0400	PSR030UL0400	400	690	700	600	200 kA	150 kA	16209	114750	63367	78	•
	PSR030US0450	PSR030UL0450	450	690	700	600	200 kA	150 kA	23133	160110	93533	80	•
	PSR030US0500	PSR030UL0500	500	690	700	600	200 kA	150 kA	31429	225180	137333	84	•
PSR030US0550	PSR030UL0550	550	690	700	600	200 kA	150 kA	44323	268920	145400	85	•	
PSR030US0630	PSR030UL0630	630	690	700	550	200 kA	150 kA	57404	480010	267800	91	•	
31	PSR031US0200	PSR031UL0200	200	690	700	600	200 kA	150 kA	1965	17334	16188	49	•
	PSR031US0250	PSR031UL0250	250	690	700	600	200 kA	150 kA	3789	35343	21080	52	•
	PSR031US0315	PSR031UL0315	315	690	700	600	200 kA	150 kA	6862	59130	30694	63	•
	PSR031US0350	PSR031UL0350	350	690	700	600	200 kA	150 kA	9523	76140	40996	67	•
	PSR031US0400	PSR031UL0400	400	690	700	600	200 kA	150 kA	14770	124335	64359	70	•
	PSR031US0450	PSR031UL0450	450	690	700	600	200 kA	150 kA	22457	178200	97444	70	•
	PSR031US0500	PSR031UL0500	500	690	700	600	200 kA	150 kA	29751	251505	125935	74	•
	PSR031US0550	PSR031UL0550	550	690	700	600	200 kA	150 kA	42056	289170	171845	86	•
	PSR031US0630	PSR031UL0630	630	690	700	600	200 kA	150 kA	73513	507465	276315	87	•
	PSR031US0700	PSR031UL0700	700	690	700	600	200 kA	150 kA	98187	601425	337260	93	•
	PSR031US0800	PSR031UL0800	800	690	700	600	200 kA	150 kA	137208	848880	502815	107	•
PSR031US0900	PSR031UL0900	900	550	600	550	200 kA	150 kA	155163	945100	631820	126	•	
32	PSR032US0400	PSR032UL0400	400	690	700	600	200 kA	150 kA	11104	79650	44533	87	•
	PSR032US0450	PSR032UL0450	450	690	700	600	200 kA	150 kA	15535	116100	65463	88	•
	PSR032US0500	PSR032UL0500	500	690	700	600	200 kA	150 kA	21573	161460	88277	94	•
	PSR032US0550	PSR032UL0550	550	690	700	600	200 kA	150 kA	26327	177660	107960	106	•
	PSR032US0630	PSR032UL0630	630	690	700	600	200 kA	150 kA	34790	234900	156963	114	•
	PSR032US0700	PSR032UL0700	700	690	700	600	200 kA	150 kA	51191	291870	209287	127	•
	PSR032US0800	PSR032UL0800	800	690	700	600	200 kA	150 kA	60125	472770	249000	152	•
	PSR032US0900	PSR032UL0900	900	690	700	600	200 kA	150 kA	107785	764100	404000	145	•
	PSR032US1000	PSR032UL1000	1000	690	700	600	200 kA	150 kA	190102	933120	672333	149	•
	PSR032US1100	PSR032UL1100	1100	690	700	600	200 kA	150 kA	225379	1247400	744000	161	•
	PSR032US1250	PSR032UL1250	1250	550**	600**	550**	200 kA	150 kA	336661	1114994	1197000	166	•
	PSR032US1400	PSR032UL1400	1400	450	500	450	200 kA	150 kA	551749	1611639	1865400	184	•
	PSR032US1500	PSR032UL1500	1500	450	500	450	200 kA	150 kA	673360	2045907	1735500	192	•
33	PSR033US0450	PSR033UL0450	450	690	700	600	200 kA	150 kA	13600	106380	58947	107	•
	PSR033US0500	PSR033UL0500	500	690	700	600	200 kA	150 kA	16434	140400	77846	107	•
	PSR033US0550	PSR033UL0550	550	690	700	600	200 kA	150 kA	23314	187650	100461	111	•
	PSR033US0630	PSR033UL0630	630	690	700	600	200 kA	150 kA	38727	285930	142437	120	•
	PSR033US0700	PSR033UL0700	700	690	700	600	200 kA	150 kA	56763	392580	209863	116	•
	PSR033US0800	PSR033UL0800	800	690	700	600	200 kA	150 kA	84691	575505	348500	122	•
	PSR033US0900	PSR033UL0900	900	690	700	600	200 kA	150 kA	122619	740340	451177	138	•
	PSR033US1000	PSR033UL1000	1000	690	700	600	200 kA	150 kA	222350	1170450	787750	138	•
	PSR033US1100	PSR033UL1100	1100	690	700	600	200 kA	150 kA	310824	1568700	821400	138	•
	PSR033US1250	PSR033UL1250	1250	690	700	500	200 kA	150 kA	476902	2403000	1674333	145	•
	PSR033US1400	PSR033UL1400	1400	690	700	500	200 kA	150 kA	583552	2920050	1979750	173	•
	PSR033US1500	PSR033UL1500	1500	600	650	500	200 kA	150 kA	674538	2433200	1996733	182	•
	PSR033US1600	PSR033UL1600	1600	600	650	500	200 kA	150 kA	779948	2942800	2301633	208	•
	PSR033US1800	PSR033UL1800	1800	600	650	500	200 kA	150 kA	952196	3785040	2724180	260	•
	PSR033US2000	PSR033UL2000	2000	550	600	480	200 kA	150 kA	1234315	4131600	3755180	264	•
	PSR033US2250	PSR033UL2250	2250	500	550	450	200 kA	150 kA	1236000	4459651	3859500	349	•

\* Electrical compliance to IEC 60269-4

\*\* Littelfuse self-certified

# POWR-SPEED® Fuse

## PSR SERIES HIGH-SPEED SQUARE BODY

### Electrical Characteristics (cont.)

CASE SIZE	CATALOG NUMBER	AMPERE RATING (A)	VOLTAGE RATING (V)			INTERRUPTING RATING		MELTING (PRE-ARC) I <sup>2</sup> T (A <sup>2</sup> S)	TOTAL CLEARING I <sup>2</sup> T (A <sup>2</sup> S) AT RATED VOLTAGE		WATT LOSS AT 100 % RATED CURRENT (W)	AGENCY CERTIFICATION
			AC		DC	AC	DC		AC	DC		
			IEC*	UL								
70	PSR070UL0050	50	1250	1300	1000	100 kA	150 kA	177	2050	400	21	•
	PSR070UL0063	63	1250	1300	1000	100 kA	150 kA	273	3399	900	24	•
	PSR070UL0080	80	1250	1300	1000	100 kA	150 kA	583	6732	2200	25	•
	PSR070UL0100	100	1250	1300	1000	100 kA	150 kA	974	10996	3750	30	•
	PSR070UL0125	125	1250	1300	1000	100 kA	150 kA	1352	13011	5150	44	•
	PSR070UL0160	160	1250	1300	1000	100 kA	150 kA	2377	25662	8950	53	•
	PSR070UL0200	200	1250	1300	1000	100 kA	150 kA	4177	39087	17267	62	•
	PSR070UL0250	250	1250	1300	1000	100 kA	150 kA	8629	89790	36750	73	•
	PSR070UL0280	280	1250	1300	1000	100 kA	150 kA	11844	113201	46750	77	•
	PSR070UL0315	315	1250	1300	1000	100 kA	150 kA	18162	142051	66833	80	•
PSR070UL0350	350	1250**	1300**	1000**	100 kA	150 kA	22963	215230	95410	76	•	
PSR070UL0400	400	1100	1200	900	100 kA	150 kA	37103	283480	154320	78	•	
71	PSR071UL0160	160	1250	1300	1000	100 kA	150 kA	2756	24600	8800	45	•
	PSR071UL0200	200	1250	1300	1000	100 kA	150 kA	4918	50307	19050	52	•
	PSR071UL0250	250	1250	1300	1000	100 kA	150 kA	10592	104427	43100	55	•
	PSR071UL0280	280	1250	1300	1000	100 kA	150 kA	13763	131897	54150	58	•
	PSR071UL0315	315	1250	1300	1000	100 kA	150 kA	20882	200244	67450	59	•
	PSR071UL0350	350	1250	1300	1000	100 kA	150 kA	23301	225500	102500	70	•
	PSR071UL0400	400	1250	1300	1000	100 kA	150 kA	43211	374986	185000	76	•
	PSR071UL0450	450	1250	1300	1000	100 kA	150 kA	55915	452394	241333	88	•
	PSR071UL0500	500	1100	1200	900	100 kA	150 kA	75315	468845	253960	93	•
	PSR071UL0550	550	1100	1200	900	100 kA	150 kA	87328	693507	332600	90	•
PSR071UL0630	630	1000	1100	900	100 kA	150 kA	131240	790862	426550	103	•	
72	PSR072UL0250	250	1250	1300	1000	100 kA	150 kA	7737	72789	28567	64	•
	PSR072UL0280	280	1250	1300	1000	100 kA	150 kA	10915	124538	46897	62	•
	PSR072UL0315	315	1250	1300	1000	100 kA	150 kA	16187	145140	58867	69	•
	PSR072UL0350	350	1250	1300	1000	100 kA	150 kA	18727	160447	69633	81	•
	PSR072UL0400	400	1250	1300	1000	100 kA	150 kA	27112	243540	108000	93	•
	PSR072UL0450	450	1250	1300	1000	100 kA	150 kA	35927	406413	159133	107	•
	PSR072UL0500	500	1250	1300	1000	100 kA	150 kA	50398	425375	216333	115	•
	PSR072UL0550	550	1250	1300	1000	100 kA	150 kA	73858	539833	271333	115	•
	PSR072UL0630	630	1250	1300	1000	100 kA	150 kA	126126	942180	436000	119	•
	PSR072UL0700	700	1100	1200	900**	100 kA	150 kA	228761	1123694	715180	89	•
	PSR072UL0800	800	1100	1200	900**	100 kA	150 kA	230695	1432388	911650	129	•
	PSR072UL0900	900	1000**	1100**	900**	100 kA	150 kA	376641	1309993	1030400	131	•
PSR072UL1000	1000	850	900	800**	100 kA	150 kA	455955	1772548	1361500	156	•	
73	PSR073UL0315	315	1250	1300	1000	100 kA	150 kA	10245	106600	38650	100	•
	PSR073UL0350	350	1250	1300	1000	100 kA	150 kA	13586	159627	57467	100	•
	PSR073UL0400	400	1250	1300	1000	100 kA	150 kA	19797	211273	86800	124	•
	PSR073UL0450	450	1250	1300	1000	100 kA	150 kA	29834	279073	114333	122	•
	PSR073UL0500	500	1250	1300	1000	100 kA	150 kA	42751	416437	184500	121	•
	PSR073UL0550	550	1250	1300	1000	100 kA	150 kA	55513	491713	224500	130	•
	PSR073UL0630	630	1250	1300	1000	100 kA	150 kA	94649	804338	377500	136	•
PSR073UL0700	700	1250	1300	1000	100 kA	150 kA	158097	1170960	575667	135	•	

\* Electrical compliance to IEC 60269-4  
 \*\* Littelfuse self-certified

# POWR-SPEED® Fuse

## PSR SERIES HIGH-SPEED SQUARE BODY

### Ordering Information

CASE SIZE	BOLTED SHORT BLADE (US)			BOLTED LONG BLADE (UL)			BOX QUANTITY
	CATALOG NUMBER	ORDERING PART NUMBER	UPC	CATALOG NUMBER	ORDERING PART NUMBER	UPC	
30	PSR030US0040	PSR030US0040Z	07945825195	PSR030UL0040	PSR030UL0040Z	07945825246	3 pcs/box
	PSR030US0050	PSR030US0050Z	07945825196	PSR030UL0050	PSR030UL0050Z	07945825247	3 pcs/box
	PSR030US0063	PSR030US0063Z	07945825197	PSR030UL0063	PSR030UL0063Z	07945825248	3 pcs/box
	PSR030US0080	PSR030US0080Z	07945825198	PSR030UL0080	PSR030UL0080Z	07945825249	3 pcs/box
	PSR030US0100	PSR030US0100Z	07945825199	PSR030UL0100	PSR030UL0100Z	07945825250	3 pcs/box
	PSR030US0125	PSR030US0125Z	07945825200	PSR030UL0125	PSR030UL0125Z	07945825251	3 pcs/box
	PSR030US0160	PSR030US0160Z	07945825201	PSR030UL0160	PSR030UL0160Z	07945825252	3 pcs/box
	PSR030US0200	PSR030US0200Z	07945825202	PSR030UL0200	PSR030UL0200Z	07945825253	3 pcs/box
	PSR030US0250	PSR030US0250Z	07945825203	PSR030UL0250	PSR030UL0250Z	07945825254	3 pcs/box
	PSR030US0315	PSR030US0315Z	07945825204	PSR030UL0315	PSR030UL0315Z	07945825255	3 pcs/box
	PSR030US0350	PSR030US0350Z	07945825205	PSR030UL0350	PSR030UL0350Z	07945825256	3 pcs/box
	PSR030US0400	PSR030US0400Z	07945825206	PSR030UL0400	PSR030UL0400Z	07945825257	3 pcs/box
	PSR030US0450	PSR030US0450Z	07945825207	PSR030UL0450	PSR030UL0450Z	07945825258	3 pcs/box
	PSR030US0500	PSR030US0500Z	07945825208	PSR030UL0500	PSR030UL0500Z	07945825259	3 pcs/box
PSR030US0550	PSR030US0550Z	07945825209	PSR030UL0550	PSR030UL0550Z	07945825260	3 pcs/box	
PSR030US0630	PSR030US0630Z	07945828549	PSR030UL0630	PSR030UL0630Z	07945827828	3 pcs/box	
31	PSR031US0200	PSR031US0200Z	07945825210	PSR031UL0200	PSR031UL0200Z	07945825261	3 pcs/box
	PSR031US0250	PSR031US0250Z	07945825211	PSR031UL0250	PSR031UL0250Z	07945825262	3 pcs/box
	PSR031US0315	PSR031US0315Z	07945825212	PSR031UL0315	PSR031UL0315Z	07945825263	3 pcs/box
	PSR031US0350	PSR031US0350Z	07945825213	PSR031UL0350	PSR031UL0350Z	07945825264	3 pcs/box
	PSR031US0400	PSR031US0400Z	07945825214	PSR031UL0400	PSR031UL0400Z	07945825265	3 pcs/box
	PSR031US0450	PSR031US0450Z	07945825215	PSR031UL0450	PSR031UL0450Z	07945825266	3 pcs/box
	PSR031US0500	PSR031US0500Z	07945825216	PSR031UL0500	PSR031UL0500Z	07945825267	3 pcs/box
	PSR031US0550	PSR031US0550Z	07945825217	PSR031UL0550	PSR031UL0550Z	07945825268	3 pcs/box
	PSR031US0630	PSR031US0630Z	07945825218	PSR031UL0630	PSR031UL0630Z	07945825269	3 pcs/box
	PSR031US0700	PSR031US0700Z	07945825219	PSR031UL0700	PSR031UL0700Z	07945825270	3 pcs/box
PSR031US0800	PSR031US0800Z	07945825220	PSR031UL0800	PSR031UL0800Z	07945825271	3 pcs/box	
PSR031US0900	PSR031US0900Z	07945828550	PSR031UL0900	PSR031UL0900Z	07945827829	3 pcs/box	
32	PSR032US0400	PSR032US0400X	07945825221	PSR032UL0400	PSR032UL0400X	07945825272	1 pc/box
	PSR032US0450	PSR032US0450X	07945825222	PSR032UL0450	PSR032UL0450X	07945825273	1 pc/box
	PSR032US0500	PSR032US0500X	07945825223	PSR032UL0500	PSR032UL0500X	07945825274	1 pc/box
	PSR032US0550	PSR032US0550X	07945825224	PSR032UL0550	PSR032UL0550X	07945825275	1 pc/box
	PSR032US0630	PSR032US0630X	07945825225	PSR032UL0630	PSR032UL0630X	07945825276	1 pc/box
	PSR032US0700	PSR032US0700X	07945825226	PSR032UL0700	PSR032UL0700X	07945825277	1 pc/box
	PSR032US0800	PSR032US0800X	07945825227	PSR032UL0800	PSR032UL0800X	07945825278	1 pc/box
	PSR032US0900	PSR032US0900X	07945825228	PSR032UL0900	PSR032UL0900X	07945825279	1 pc/box
	PSR032US1000	PSR032US1000X	07945825229	PSR032UL1000	PSR032UL1000X	07945825280	1 pc/box
	PSR032US1100	PSR032US1100X	07945825230	PSR032UL1100	PSR032UL1100X	07945825281	1 pc/box
	PSR032US1250	PSR032US1250X	07945828551	PSR032UL1250	PSR032UL1250X	07945827830	1 pc/box
	PSR032US1400	PSR032US1400X	07945828552	PSR032UL1400	PSR032UL1400X	07945828531	1 pc/box
PSR032US1500	PSR032US1500X	07945828553	PSR032UL1500	PSR032UL1500X	07945828532	1 pc/box	
33	PSR033US0450	PSR033US0450X	07945825231	PSR033UL0450	PSR033UL0450X	07945825282	1 pc/box
	PSR033US0500	PSR033US0500X	07945825232	PSR033UL0500	PSR033UL0500X	07945825283	1 pc/box
	PSR033US0550	PSR033US0550X	07945825233	PSR033UL0550	PSR033UL0550X	07945825284	1 pc/box
	PSR033US0630	PSR033US0630X	07945825234	PSR033UL0630	PSR033UL0630X	07945825285	1 pc/box
	PSR033US0700	PSR033US0700X	07945825235	PSR033UL0700	PSR033UL0700X	07945825286	1 pc/box
	PSR033US0800	PSR033US0800X	07945825236	PSR033UL0800	PSR033UL0800X	07945825287	1 pc/box
	PSR033US0900	PSR033US0900X	07945825237	PSR033UL0900	PSR033UL0900X	07945825288	1 pc/box
	PSR033US1000	PSR033US1000X	07945825238	PSR033UL1000	PSR033UL1000X	07945825289	1 pc/box
	PSR033US1100	PSR033US1100X	07945825239	PSR033UL1100	PSR033UL1100X	07945825290	1 pc/box
	PSR033US1250	PSR033US1250X	07945825240	PSR033UL1250	PSR033UL1250X	07945825291	1 pc/box
	PSR033US1400	PSR033US1400X	07945825241	PSR033UL1400	PSR033UL1400X	07945825292	1 pc/box
	PSR033US1500	PSR033US1500X	07945825242	PSR033UL1500	PSR033UL1500X	07945825293	1 pc/box
	PSR033US1600	PSR033US1600X	07945825243	PSR033UL1600	PSR033UL1600X	07945825294	1 pc/box
	PSR033US1800	PSR033US1800X	07945825244	PSR033UL1800	PSR033UL1800X	07945825295	1 pc/box
	PSR033US2000	PSR033US2000X	07945825245	PSR033UL2000	PSR033UL2000X	07945825296	1 pc/box
	PSR033US2250	PSR033US2250X	07945828554	PSR033UL2250	PSR033UL2250X	07945828533	1 pc/box

# POWR-SPEED® Fuse

## PSR SERIES HIGH-SPEED SQUARE BODY

### Ordering Information (cont.)

CASE SIZE	BOLTED LONG BLADE (UL)			BOX QUANTITY
	CATALOG NUMBER	ORDERING PART NUMBER	UPC	
70	PSR070UL0050	PSR070UL0050Z	07945825297	3 pcs/box
	PSR070UL0063	PSR070UL0063Z	07945825298	3 pcs/box
	PSR070UL0080	PSR070UL0080Z	07945825299	3 pcs/box
	PSR070UL0100	PSR070UL0100Z	07945825300	3 pcs/box
	PSR070UL0125	PSR070UL0125Z	07945825301	3 pcs/box
	PSR070UL0160	PSR070UL0160Z	07945825302	3 pcs/box
	PSR070UL0200	PSR070UL0200Z	07945825303	3 pcs/box
	PSR070UL0250	PSR070UL0250Z	07945825304	3 pcs/box
	PSR070UL0280	PSR070UL0280Z	07945825305	3 pcs/box
	PSR070UL0315	PSR070UL0315Z	07945825306	3 pcs/box
	PSR070UL0350	PSR070UL0350Z	07945828534	3 pcs/box
	PSR070UL0400	PSR070UL0400Z	07945828535	3 pcs/box
71	PSR071UL0160	PSR071UL0160Z	07945825307	3 pcs/box
	PSR071UL0200	PSR071UL0200Z	07945825308	3 pcs/box
	PSR071UL0250	fPSR071UL0250Z	07945825309	3 pcs/box
	PSR071UL0280	PSR071UL0280Z	07945825310	3 pcs/box
	PSR071UL0315	PSR071UL0315Z	07945825311	3 pcs/box
	PSR071UL0350	PSR071UL0350Z	07945825312	3 pcs/box
	PSR071UL0400	PSR071UL0400Z	07945825313	3 pcs/box
	PSR071UL0450	PSR071UL0450Z	07945825314	3 pcs/box
	PSR071UL0500	PSR071UL0500Z	07945828536	3 pcs/box
	PSR071UL0550	PSR071UL0550Z	07945828537	3 pcs/box
	PSR071UL0630	PSR071UL0630Z	07945828538	3 pcs/box
72	PSR072UL0250	PSR072UL0250X	07945825315	1 pc/box
	PSR072UL0280	PSR072UL0280X	07945825316	1 pc/box
	PSR072UL0315	PSR072UL0315X	07945825317	1 pc/box
	PSR072UL0350	PSR072UL0350X	07945825318	1 pc/box
	PSR072UL0400	PSR072UL0400X	07945825319	1 pc/box
	PSR072UL0450	PSR072UL0450X	07945825320	1 pc/box
	PSR072UL0500	PSR072UL0500X	07945825321	1 pc/box
	PSR072UL0550	PSR072UL0550X	07945825322	1 pc/box
	PSR072UL0630	PSR072UL0630X	07945825323	1 pc/box
	PSR072UL0700	PSR072UL0700X	07945828539	1 pc/box
	PSR072UL0800	PSR072UL0800X	07945828540	1 pc/box
	PSR072UL0900	PSR072UL0900X	07945828541	1 pc/box
	PSR072UL1000	PSR072UL1000X	07945828542	1 pc/box
73	PSR073UL0315	PSR073UL0315X	07945825324	1 pc/box
	PSR073UL0350	PSR073UL0350X	07945825325	1 pc/box
	PSR073UL0400	PSR073UL0400X	07945825326	1 pc/box
	PSR073UL0450	PSR073UL0450X	07945825327	1 pc/box
	PSR073UL0500	PSR073UL0500X	07945825328	1 pc/box
	PSR073UL0550	PSR073UL0550X	07945825329	1 pc/box
	PSR073UL0630	PSR073UL0630X	07945825330	1 pc/box
		PSR073UL0700	PSR073UL0700X	07945825331

# POWR-SPEED® Fuse

## PSR SERIES HIGH-SPEED SQUARE BODY

### Dimensions (US and UL)

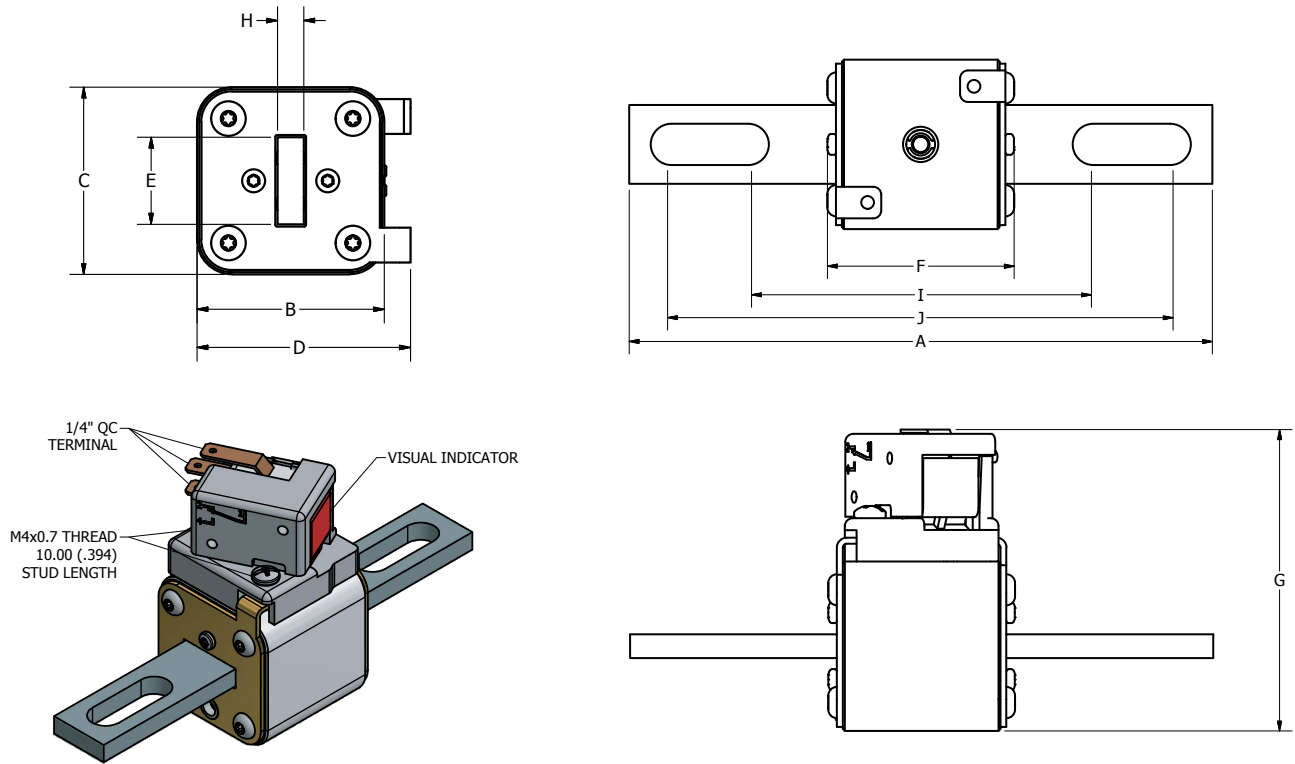

DIMENSIONS MM (IN)													
CASE SIZE	MOUNTING STYLE	A	B	C	D	E	F	G	H	I	J	RECOMMENDED FASTENER	TIGHTENING TORQUE (REFERENCE ONLY)
30	Short [US]	127.2 (5.01)	43.0 (1.69)	43.0 (1.69)	49.0 (1.93)	20.0 (0.79)	47.7 (1.88)	76.4 (3.01)	6.0 (0.24)	69.5 (2.74)	106.3 (4.19)	10 mm (3/8)	26 Nm
	Long [UL]	148.0 (5.83)	43.0 (1.69)	43.0 (1.69)	49.0 (1.93)	20.0 (0.79)	47.7 (1.88)	76.4 (3.01)	6.0 (0.24)	88.5 (3.48)	125.8 (4.95)	10 mm (3/8)	26 Nm
31	Short [US]	133.2 (5.24)	51.5 (2.03)	51.5 (2.03)	57.5 (2.26)	25.0 (0.98)	49.2 (1.94)	84.9 (3.34)	6.0 (0.24)	68.8 (2.71)	108.3 (4.26)	12 mm (1/2)	64 Nm
	Long [UL]	153.2 (6.03)	51.5 (2.03)	51.5 (2.03)	57.5 (2.26)	25.0 (0.98)	49.2 (1.94)	84.9 (3.34)	6.0 (0.24)	92.3 (3.63)	128.3 (5.05)	12 mm (1/2)	64 Nm
32	Short [US]	133.2 (5.24)	60.0 (2.36)	60.0 (2.36)	66.0 (2.60)	25.0 (0.98)	49.2 (1.94)	93.4 (3.68)	6.0 (0.24)	68.8 (2.71)	108.3 (4.26)	12 mm (1/2)	64 Nm
	Long [UL]	153.2 (6.03)	60.0 (2.36)	60.0 (2.36)	66.0 (2.60)	25.0 (0.98)	49.2 (1.94)	93.4 (3.68)	6.0 (0.24)	92.3 (3.63)	128.3 (5.05)	12 mm (1/2)	64 Nm
33	Short [US]	135.4 (5.33)	73.5 (2.89)	73.5 (2.89)	79.5 (3.13)	36.0 (1.41)	50.2 (1.98)	106.9 (4.21)	6.0 (0.24)	75.8 (2.98)	107.3 (4.22)	14 mm (9/16)	92 Nm
	Long [UL]	155.2 (6.11)	73.5 (2.89)	73.5 (2.89)	79.5 (3.13)	36.0 (1.41)	50.2 (1.98)	106.9 (4.21)	6.0 (0.24)	94.8 (3.73)	126.3 (4.97)	14 mm (9/16)	92 Nm
70	Long [UL]	151.2 (5.95)	43.0 (1.69)	43.0 (1.69)	49.0 (1.93)	20.0 (0.79)	71.7 (2.82)	76.4 (3.01)	6.0 (0.24)	92.8 (3.65)	130.3 (5.13)	10 mm (3/8)	26 Nm
71	Long [UL]	157.0 (6.18)	51.5 (2.03)	51.5 (2.03)	57.5 (2.26)	25.0 (0.98)	73.2 (2.88)	84.9 (3.34)	6.0 (0.24)	92.8 (3.65)	132.3 (5.21)	12 mm (1/2)	64 Nm
72	Long [UL]	157.2 (6.19)	60.0 (2.36)	60.0 (2.36)	66.0 (2.60)	25.0 (0.98)	73.2 (2.88)	93.4 (3.68)	6.0 (0.24)	92.8 (3.65)	132.3 (5.21)	12 mm (1/2)	64 Nm
73	Long [UL]	159.4 (6.28)	73.5 (2.89)	73.5 (2.89)	79.5 (3.13)	36.0 (1.41)	74.2 (2.92)	106.9 (4.21)	6.0 (0.24)	99.8 (3.93)	131.3 (5.17)	14 mm (9/16)	92 Nm

# POWR-SPEED® Fuse

## PSR SERIES HIGH-SPEED SQUARE BODY

### Time Current Curve (30 Case Size)

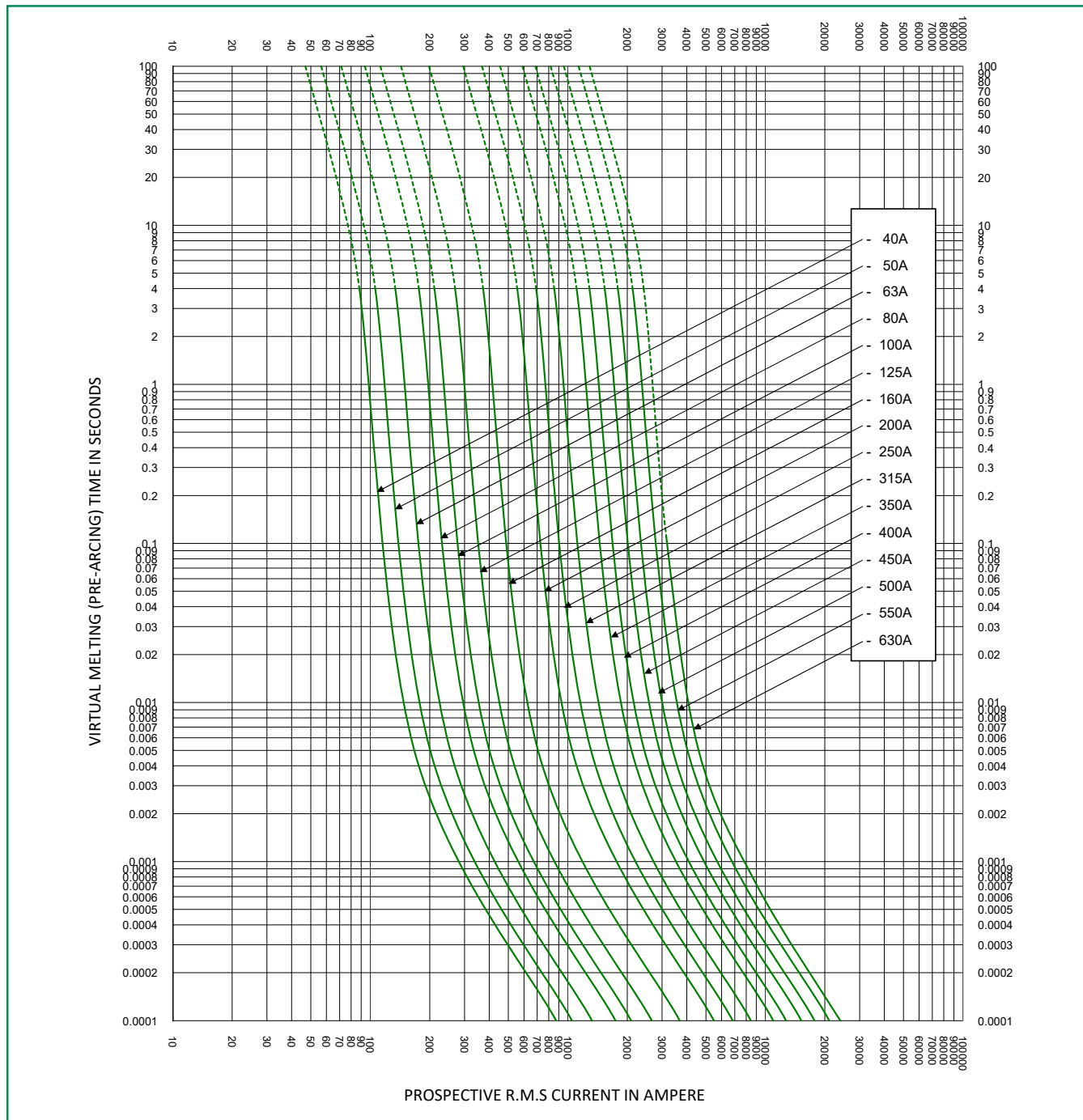

\* Dc minimum breaking capacity = 9 x I<sub>n</sub>

# POWR-SPEED® Fuse

## PSR SERIES HIGH-SPEED SQUARE BODY

### Time Current Curve (31 Case Size)

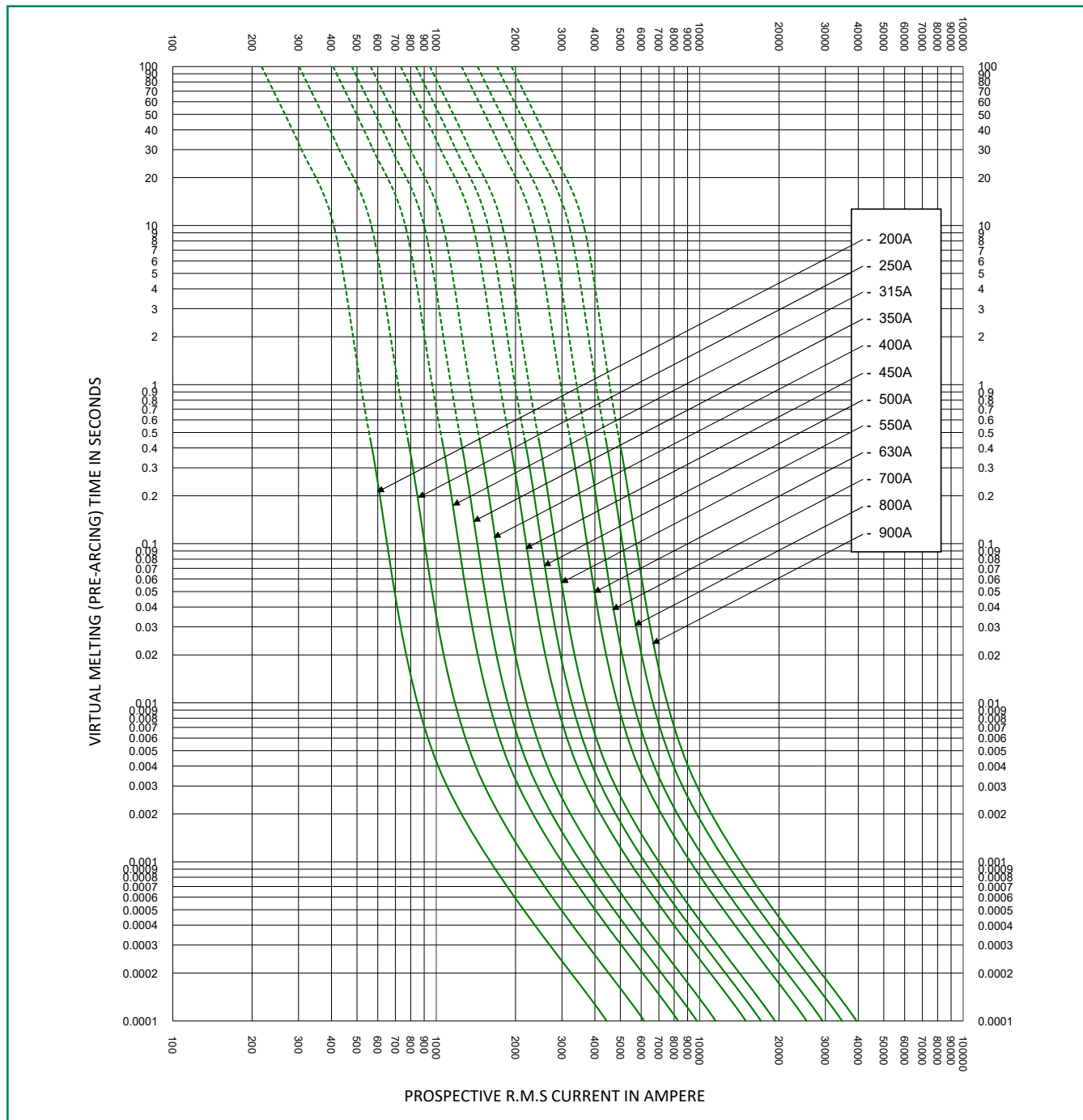

\* Dc minimum breaking capacity = 9 x I<sub>n</sub>

# POWR-SPEED® Fuse

## PSR SERIES HIGH-SPEED SQUARE BODY

### Time Current Curve (32 Case Size)

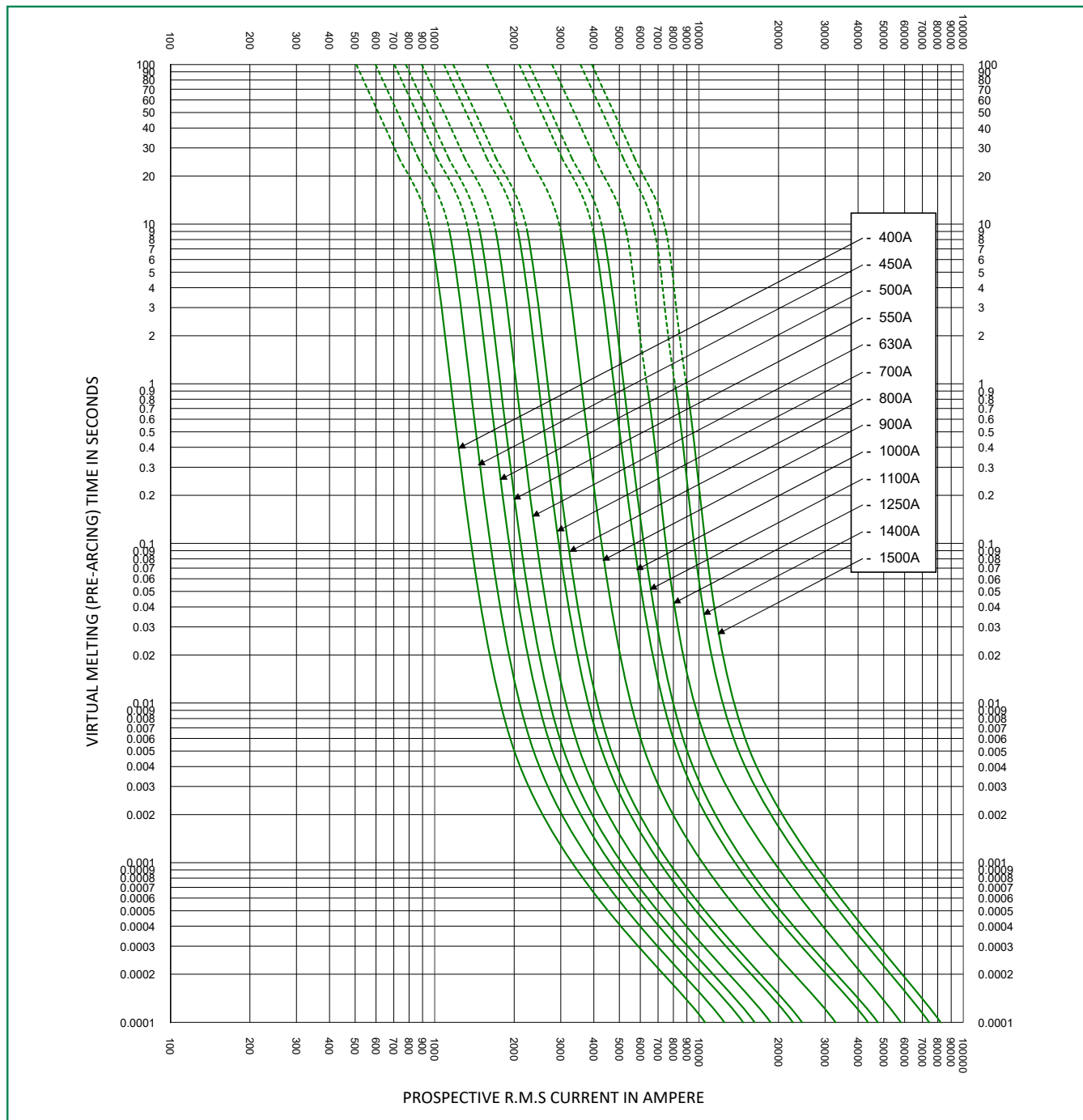

\* Dc minimum breaking capacity = 9 x In

# POWR-SPEED® Fuse

## PSR SERIES HIGH-SPEED SQUARE BODY

### Time Current Curve (33 Case Size)

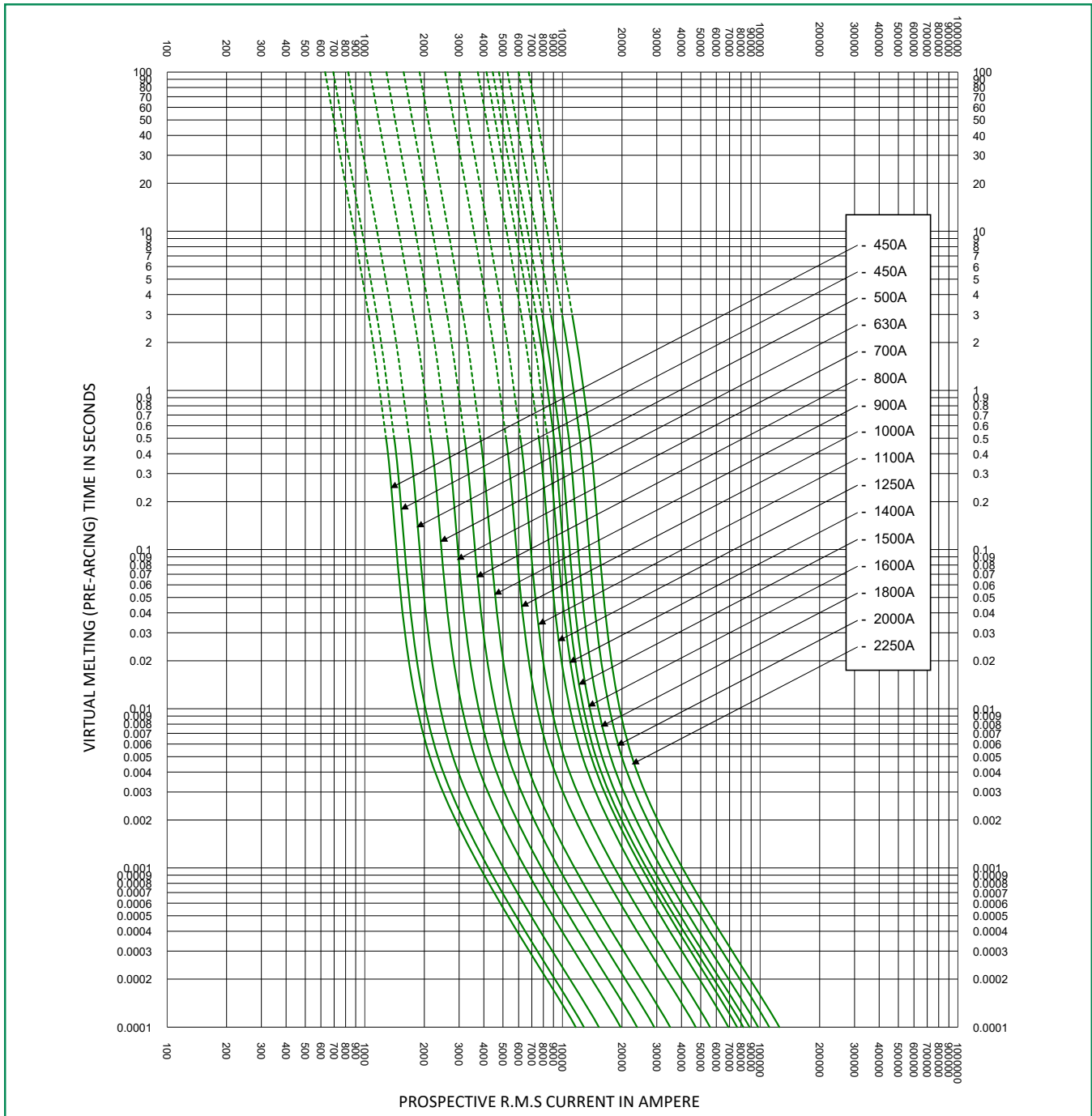

\* Dc minimum breaking capacity = 9 x In

**Time Current Curve (70 Case Size)**

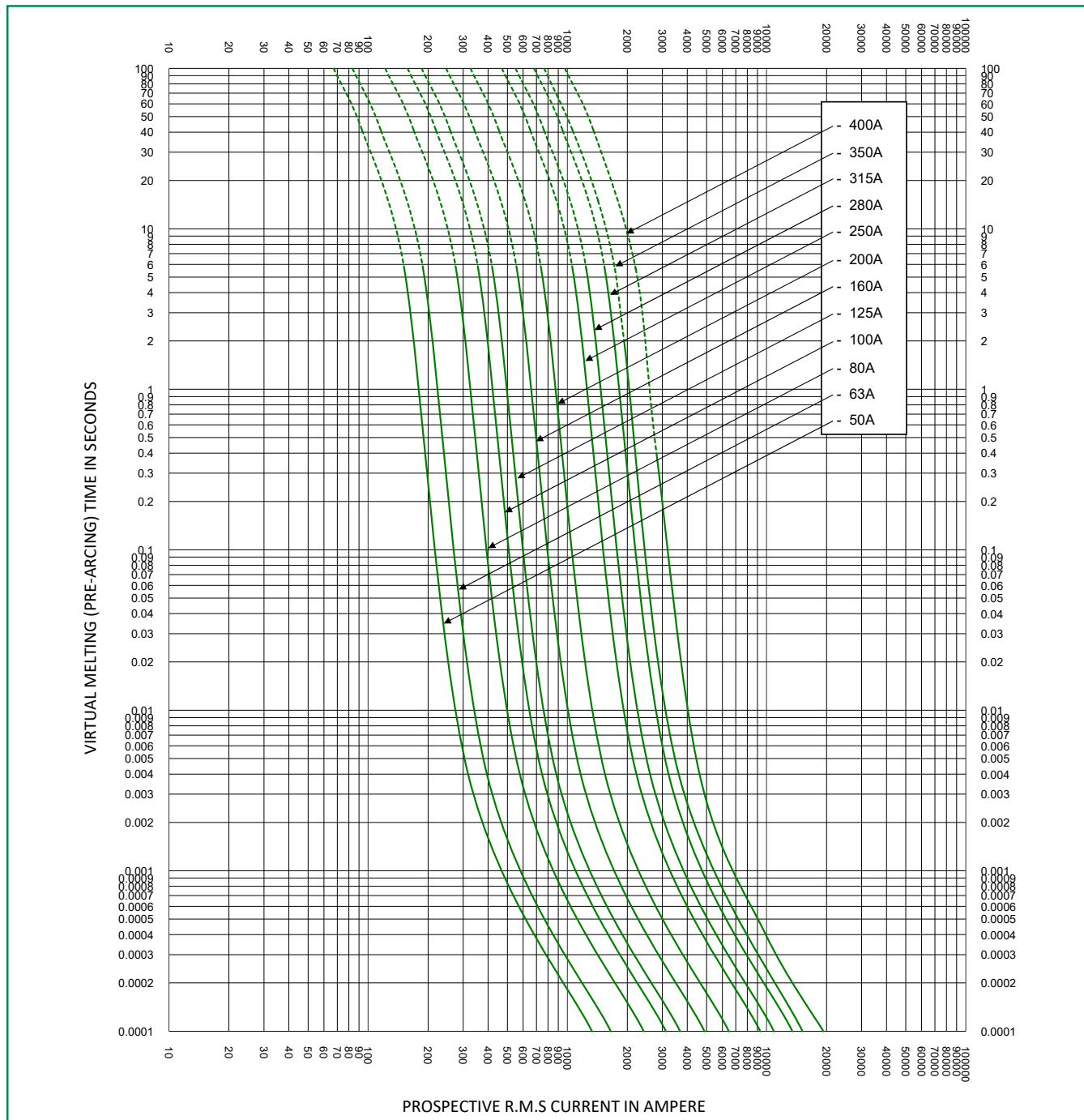

\* Dc minimum breaking capacity = 9 x I<sub>n</sub>

**Time Current Curve (71 Case Size)**

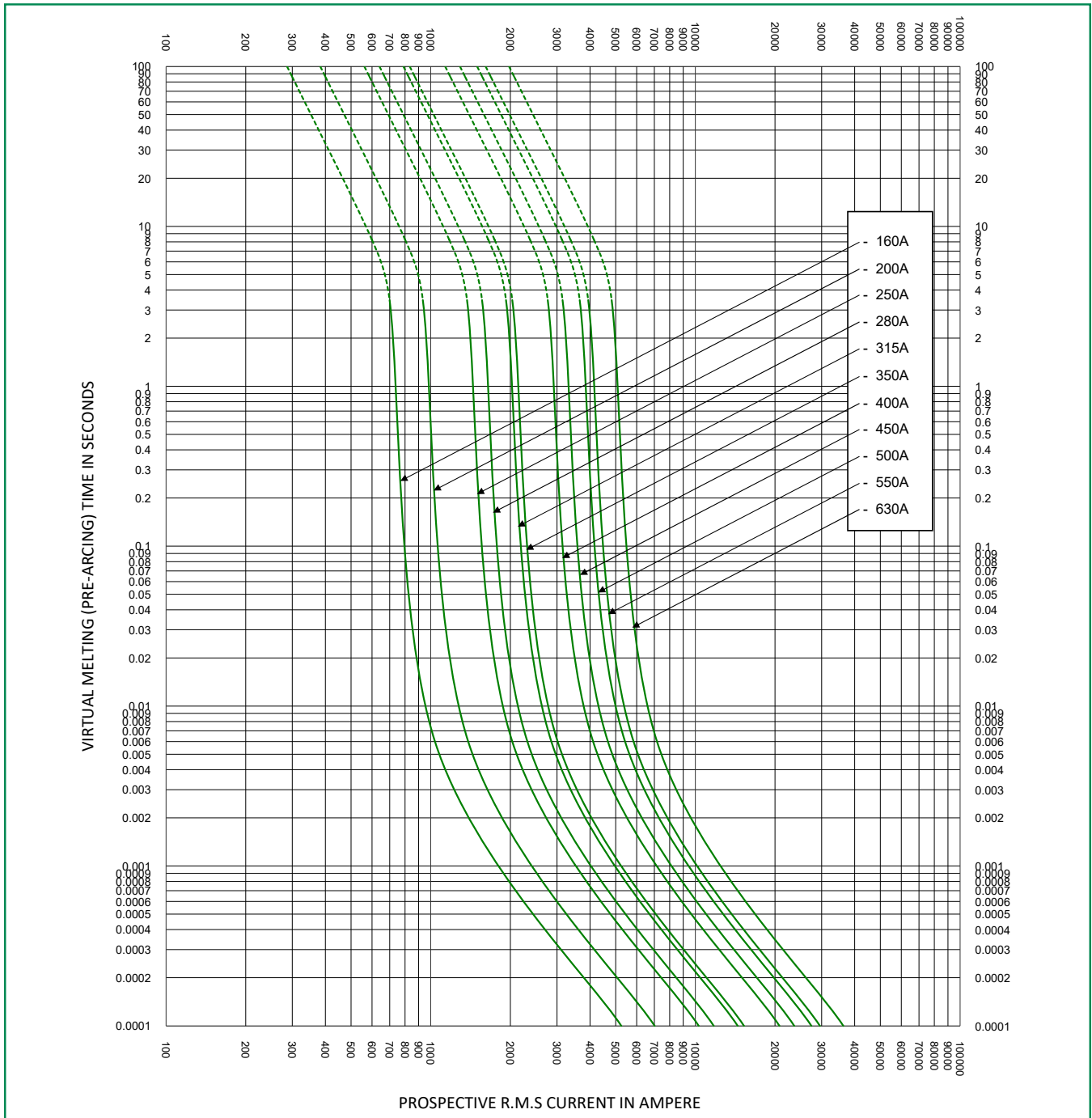

\* Dc minimum breaking capacity = 9 x In

# POWR-SPEED® Fuse

## PSR SERIES HIGH-SPEED SQUARE BODY

### Time Current Curve (72 Case Size)

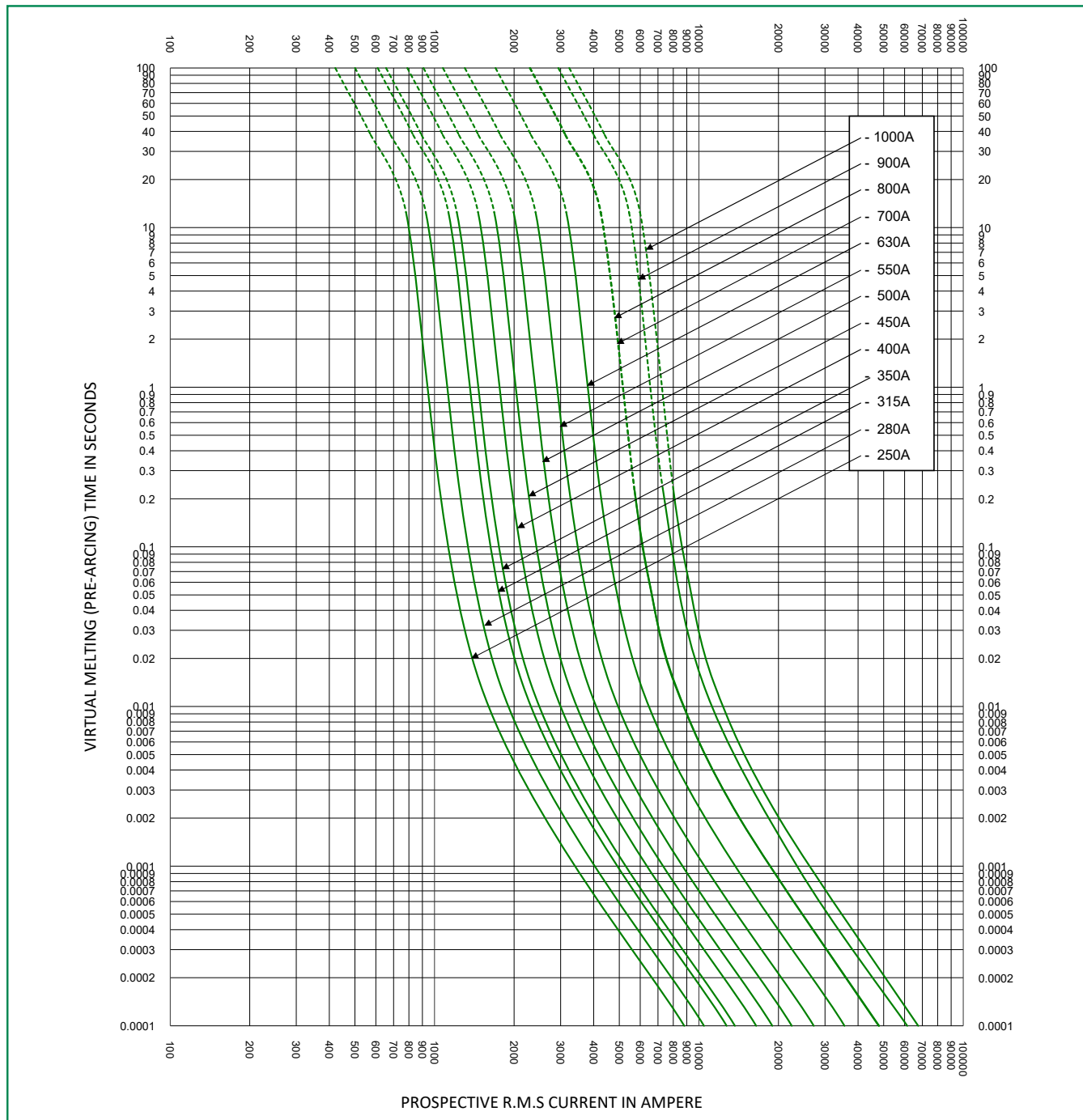

\* Dc minimum breaking capacity = 9 x I<sub>n</sub>

# POWR-SPEED® Fuse

## PSR SERIES HIGH-SPEED SQUARE BODY

### Time Current Curve (73 Case Size)

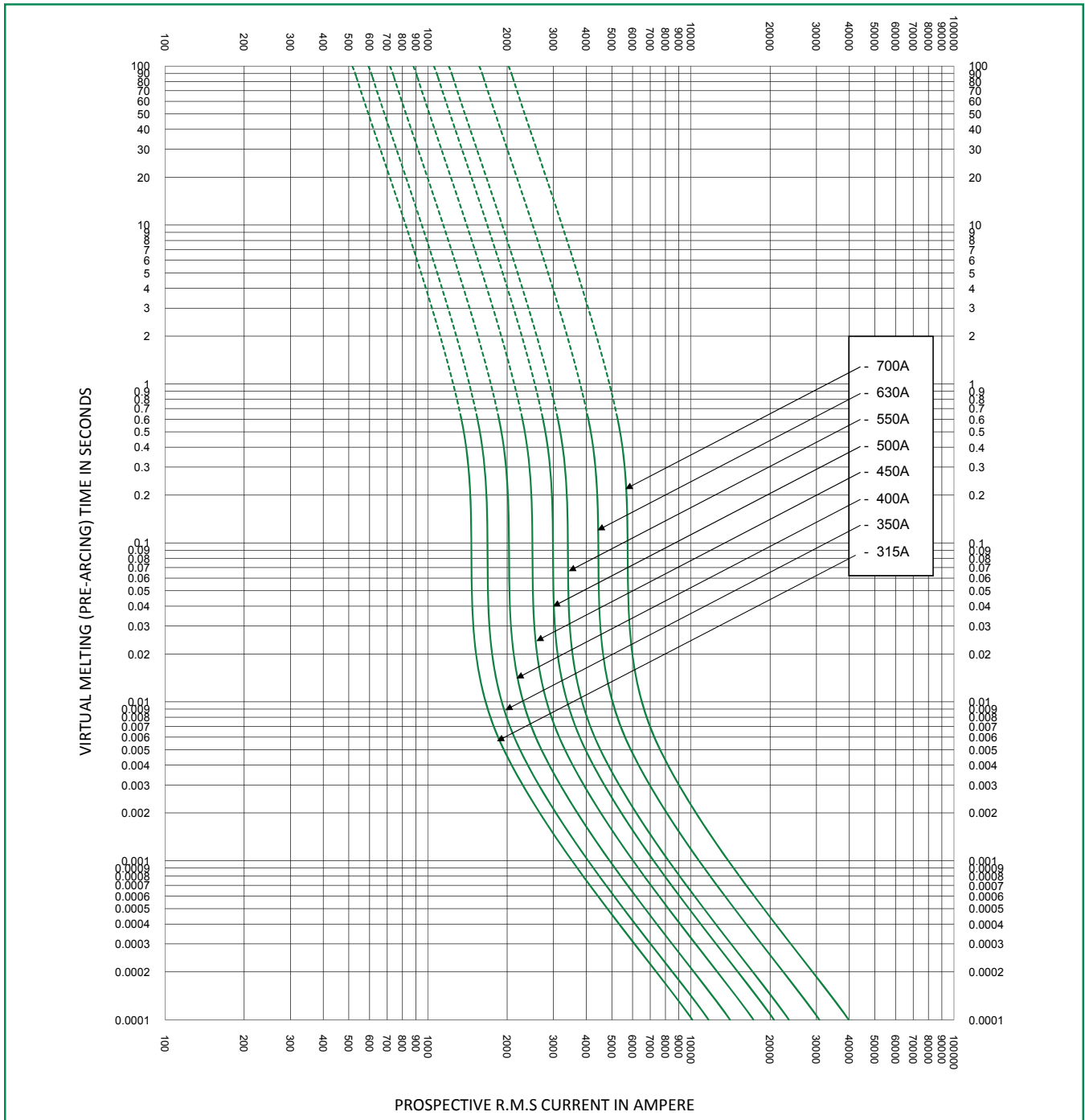

\* Dc minimum breaking capacity = 9 x In

**Peak Let-Through Curve (30 Case Size)**

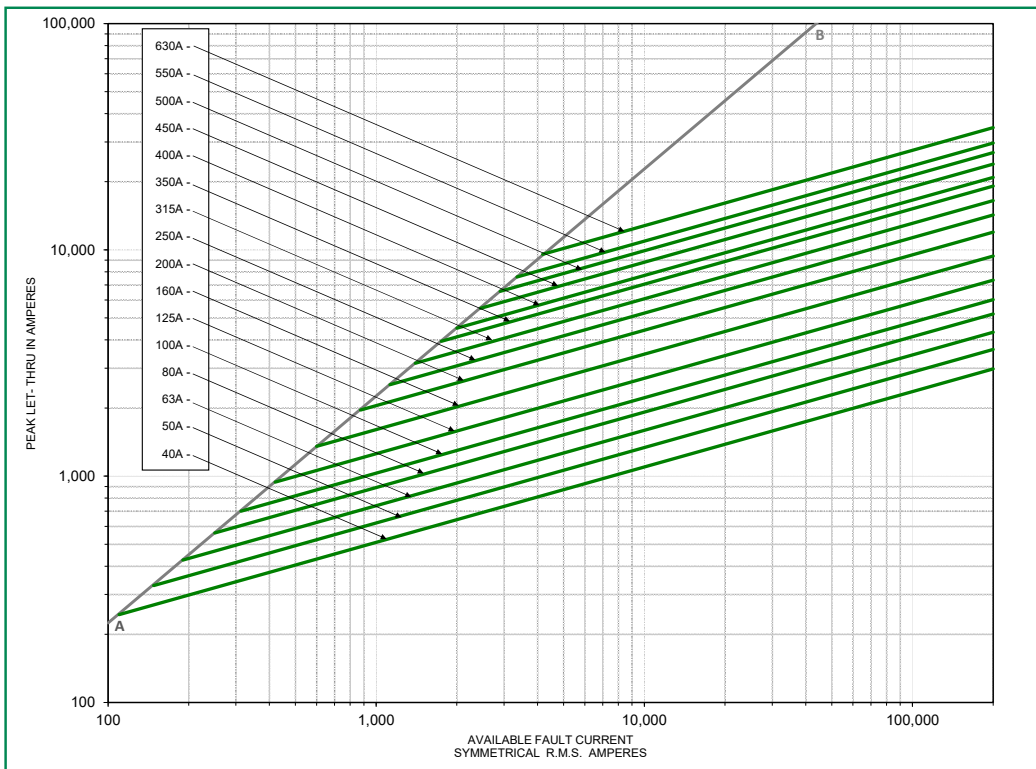

**Peak Let-Through Curve (31 Case Size)**

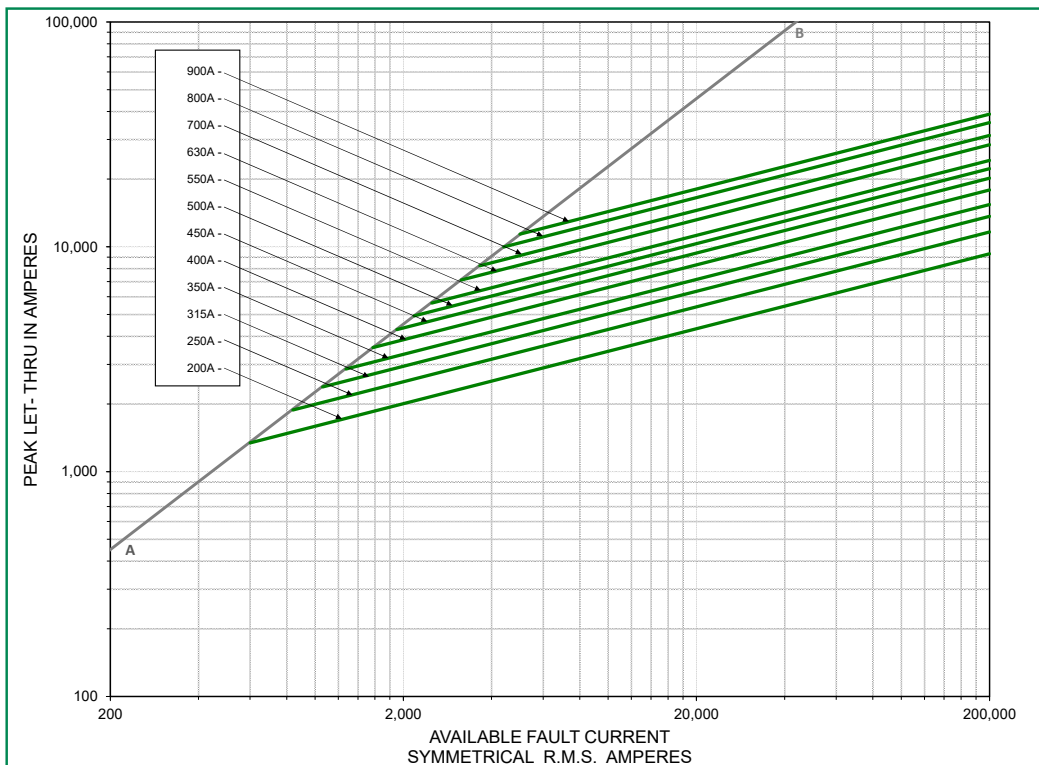

**Peak Let-Thru Curve (32 Case Size)**

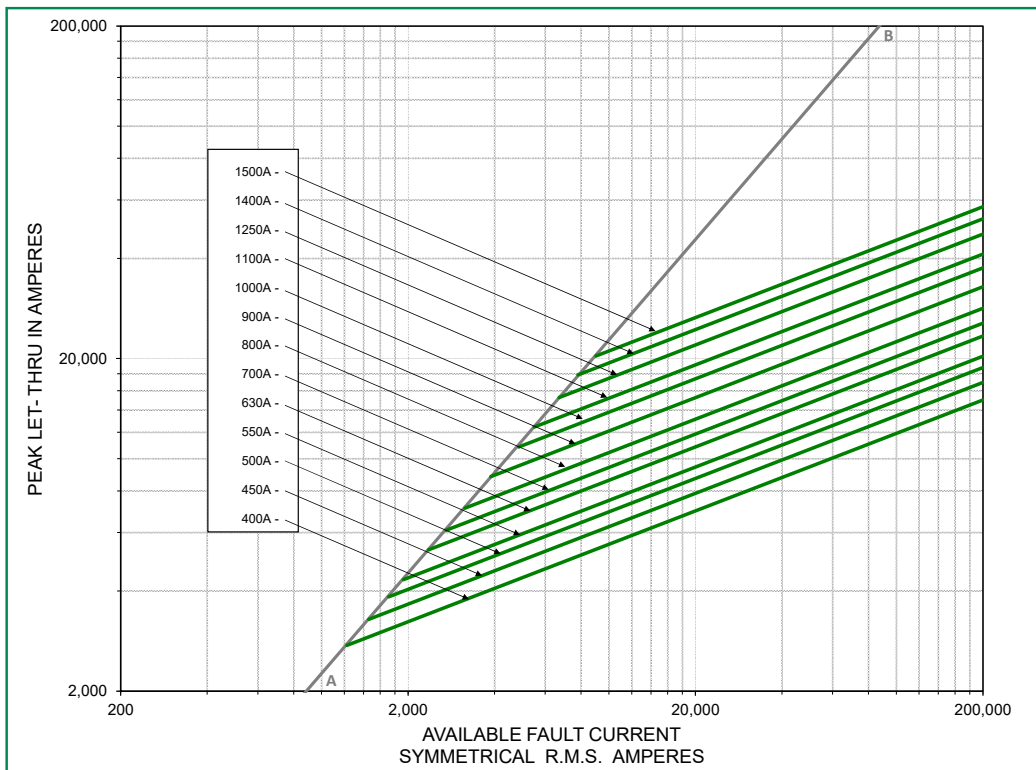

**Peak Let-Thru Curve (33 Case Size)**

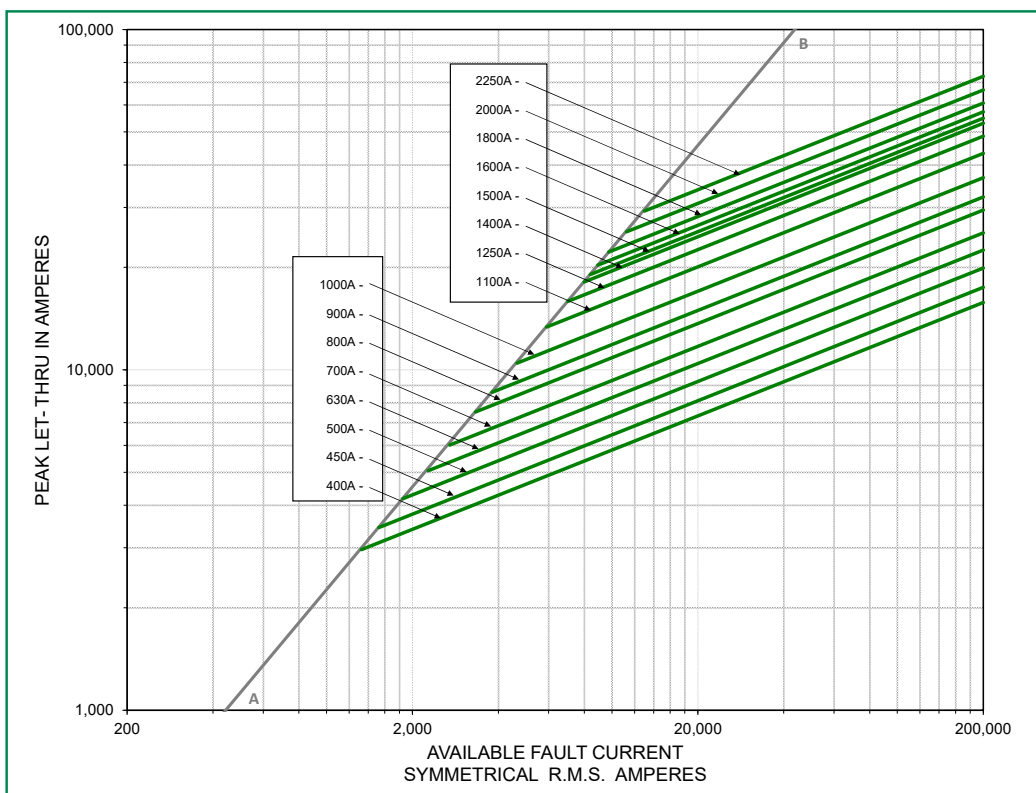

**Peak Let-Thru Curve (70 Case Size)**

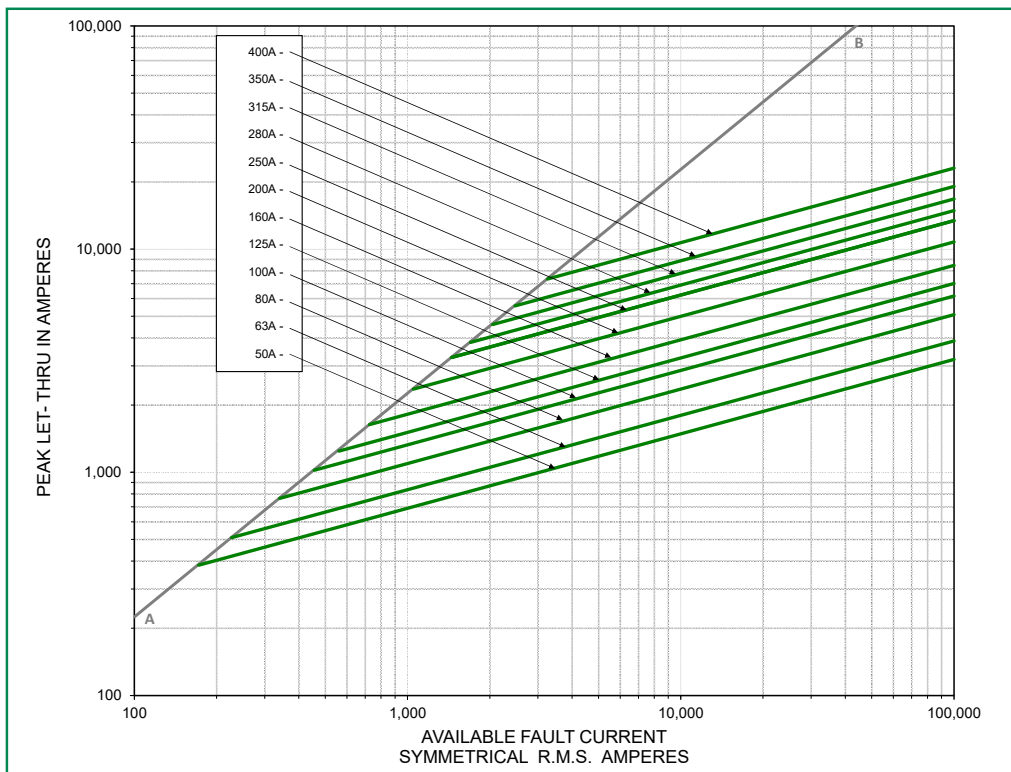

**Peak Let-Thru Curve (71 Case Size)**

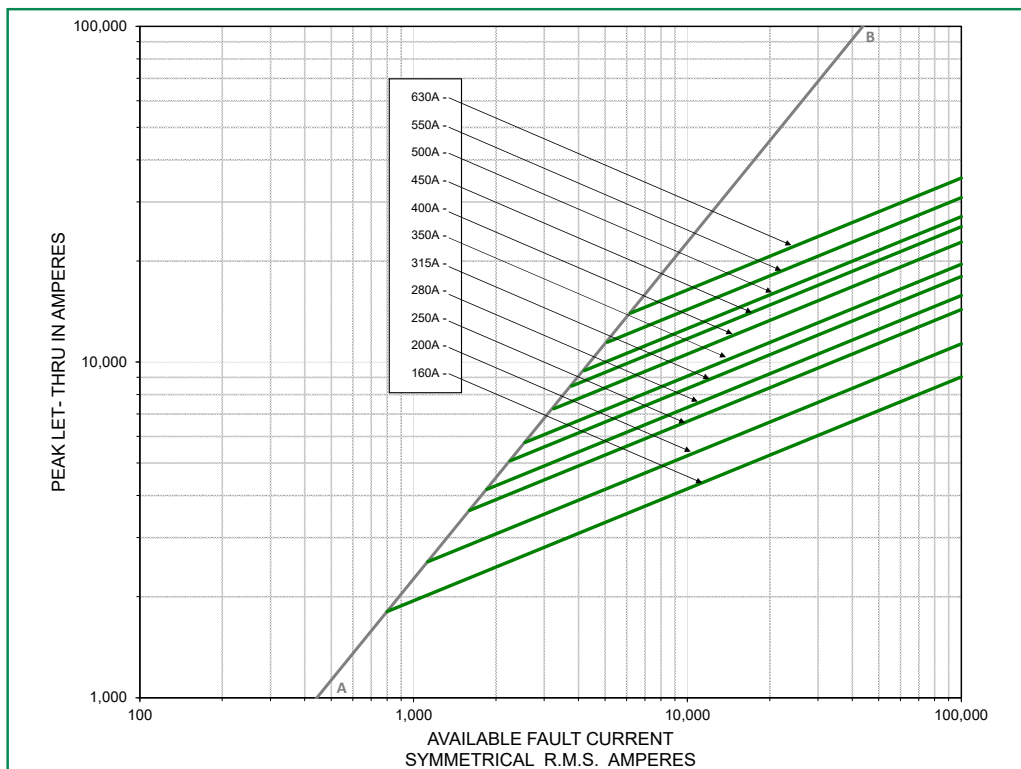

**Peak Let-Thru Curve (72 Case Size)**

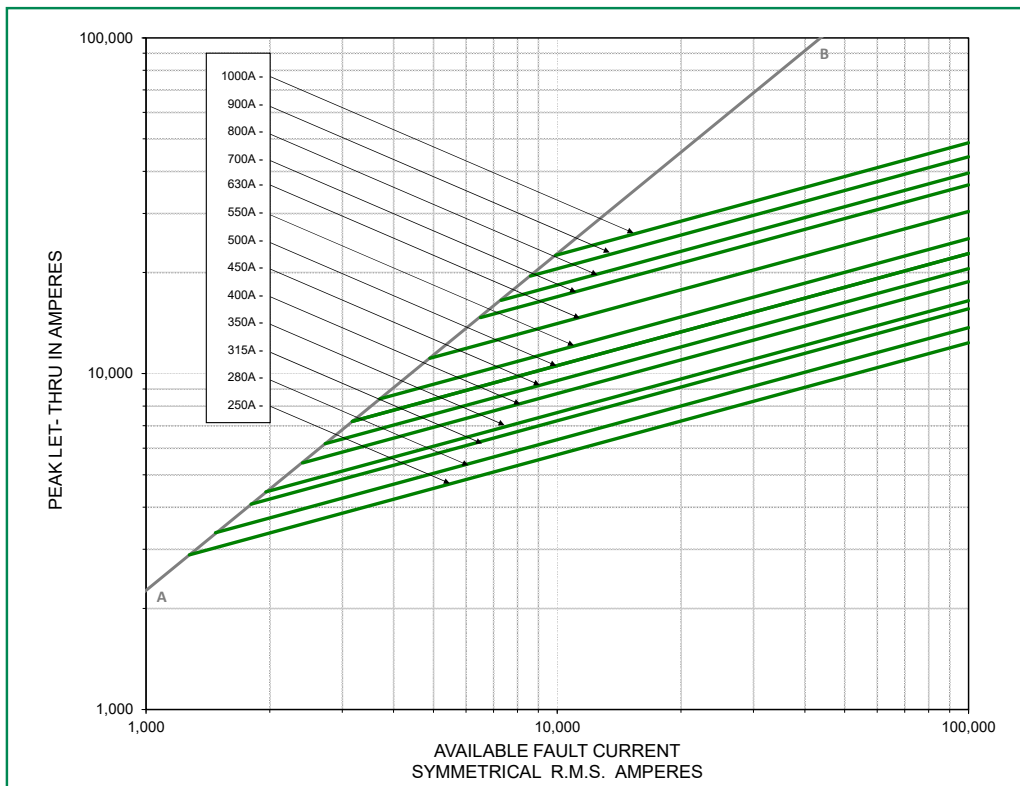

**Peak Let-Thru Curve (73 Case Size)**

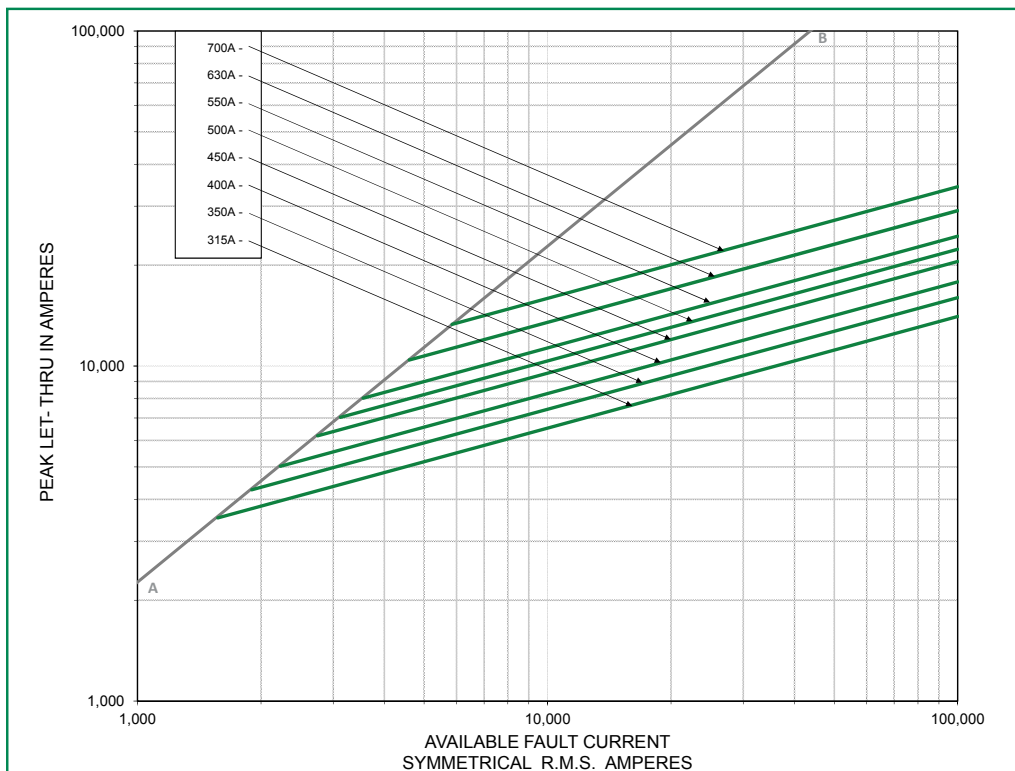

**Total Clearing I<sup>2</sup>t Correction Factor Curve**  
 (30, 31, 32 and 33 Case Sizes)

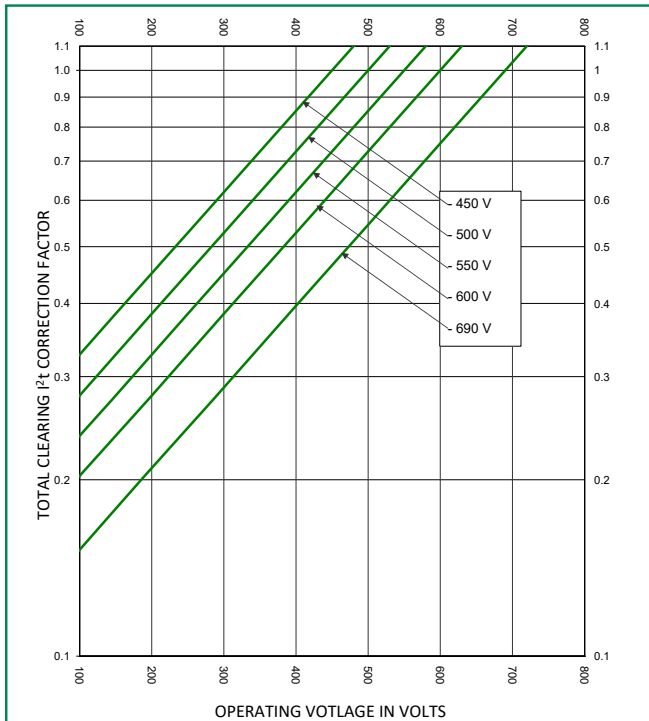

**Total Clearing I<sup>2</sup>t Correction Factor Curve**  
 (70, 71, 72 and 73 Case Sizes)

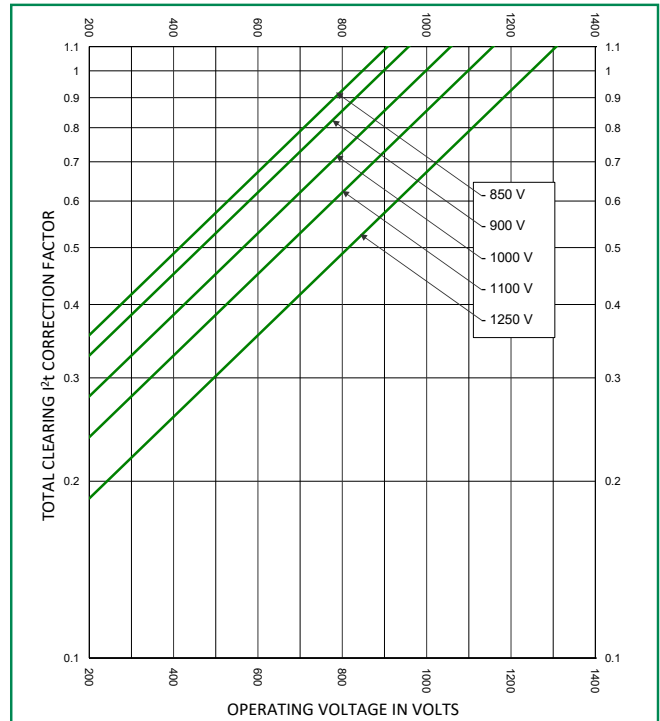

**Peak Arc Voltage Curve**  
 (30, 31, 32 and 33 Case Sizes)

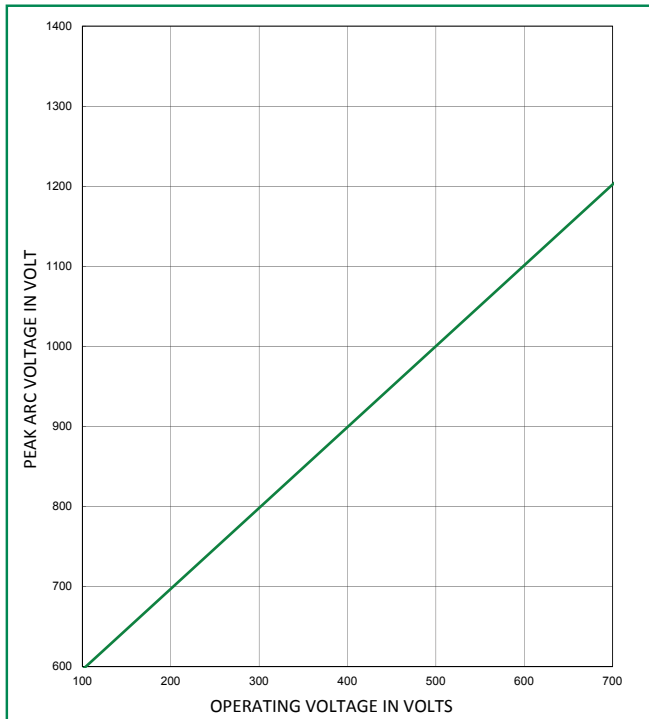

**Peak Arc Voltage Curve**  
 (70, 71, 72 and 73 Case Sizes)

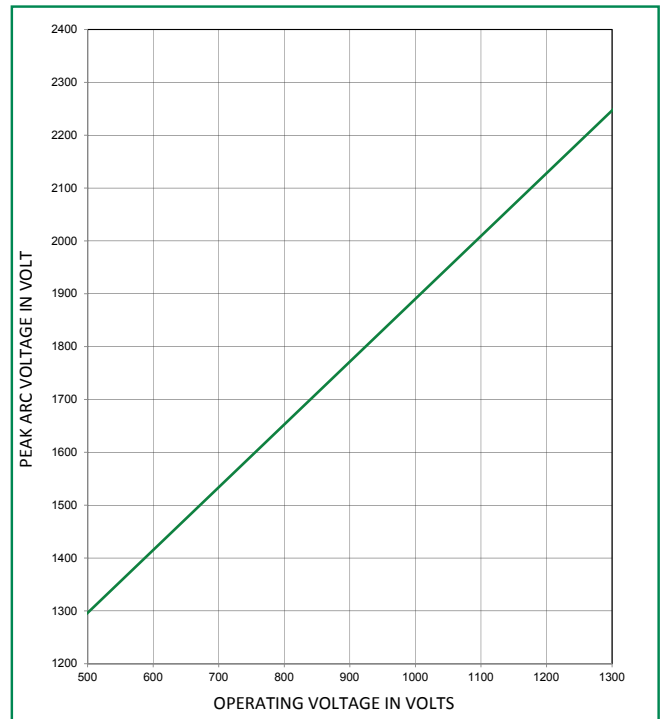

**Temperature Derating Curve**  
 (temperature of air immediately surrounding fuse)

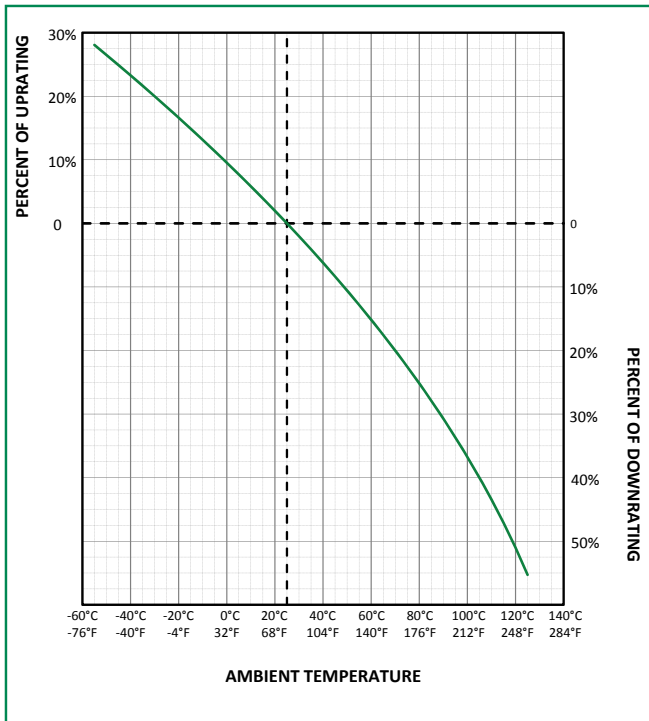

**Watts Loss Correction Factor Curve**

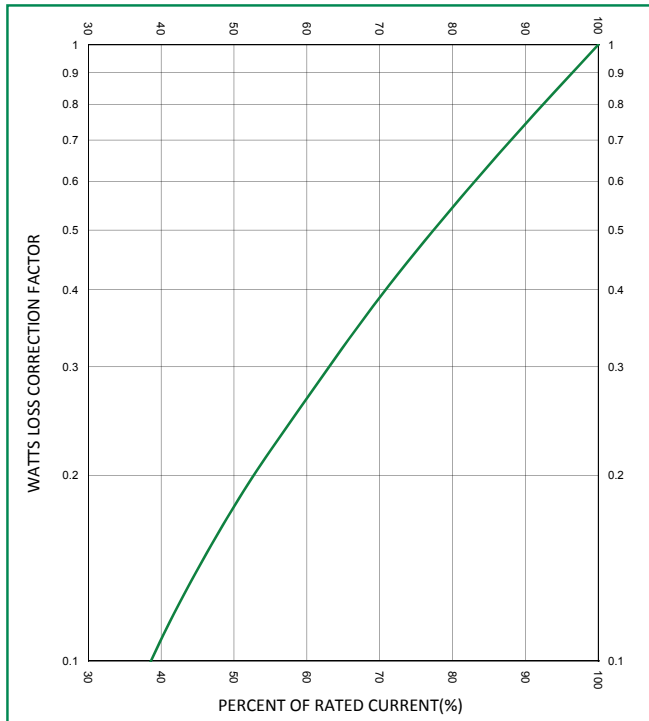

**Disclaimer Notice** – Information furnished is believed to be accurate and reliable. However, users should independently evaluate the suitability of and test each product selected for their own applications. Littelfuse products are not designed for, and may not be used in, all applications. Read complete Disclaimer Notice at [www.littelfuse.com/product-disclaimer](http://www.littelfuse.com/product-disclaimer).