

US CATALOG

# System pro M compact™

## Circuit Protection Devices on DIN Rail



---

# Table of contents

<b>004</b>	<b>Overview UL 489 circuit breakers</b>
<b>005–007</b>	<b>SU200M series</b>
<b>008–010</b>	<b>SU200ML series</b>
<b>011–013</b>	<b>SUP200M series</b>
<b>014</b>	<b>SU200MR series</b>
<b>015–016</b>	<b>S200UDC series</b>
<b>017–018</b>	<b>S800U series</b>
<b>019</b>	<b>S804U-UCZ series</b>
<b>020–029</b>	<b>Accessories and busbars</b>
<b>030–043</b>	<b>Technical data and drawings</b>
<b>044</b>	<b>Overview UL 1077 supplementary protectors</b>
<b>045–054</b>	<b>ST200M series</b>
<b>055</b>	<b>S200MR series</b>
<b>056–058</b>	<b>S200MUC series</b>
<b>059–062</b>	<b>S800C series</b>
<b>063–066</b>	<b>S800S series</b>
<b>067</b>	<b>S800P series</b>
<b>068–072</b>	<b>S300 P series</b>
<b>073–076</b>	<b>ST200MTR series</b>
<b>077–085</b>	<b>Accessories and busbars</b>
<b>086–097</b>	<b>Technical data and drawings</b>

---

# Table of contents

<b>098–099</b>	<b>S804U-PVS5 GFDI</b>
<b>100–101</b>	<b>S803W-SCL-SR short-circuit current limiter</b>
<b>102–103</b>	<b>EPD24 electronic circuit breakers</b>
<b>104–111</b>	<b>MCB technology application guide</b>
<b>113–120</b>	<b>Ground-fault protective devices</b>
<b>121–124</b>	<b>DS201 residual current devices</b>
<b>126–136</b>	<b>E 90 fuse holders</b>
<b>137</b>	<b>Surge protective devices</b>
<b>138–147</b>	<b>SPD - OVRT2 series</b>
<b>148–149</b>	<b>SPD - OVR PV Type 2 series</b>
<b>150–157</b>	<b>SPD - OVR RS485Q and SL RS485 series</b>

# UL 489 series

## SU200M, SUP200M, SU200MR, SU200ML, S200UDC, S800U, S800U-UCZ



### Description

ABB's UL 489 miniature circuit breakers offer a compact solution for all branch circuit protection requirements. They are current-limiting according to UL 489 and DIN rail mounted.

ABB's UL 489 MCBs come in up to three trip curves to provide maximum circuit protection.

For the worldwide market, the breakers carry UL, CSA, IEC, CE and many other agency approvals and certifications.



### Features

- UL current limiting
- Fast breaking time (2.3–2.5 ms)
- Bus connection system
- Wide range of accessories
- Available with variable depth handle mechanism
- CE certified and marked
- DIN rail mounting
- Finger-safe terminals
- Multi-function terminals
- Suitable for reverse feed (except for S200UDC)
- UL 489 listed branch circuit protective device, UL File #E212323 and E312425

	SU200M	SU200ML	SUP200M	SU200MR	S200UDC
Ampacities	0.2–63	0.2–63	1–40 (K: 35)	0.2–63	1–63
Voltage	up to 480Y/ 277 V AC 48/96 V DC	230 V AC 1P: 48 V DC and 2P: 96 V DC (2P in series)	480Y/277 V AC 48/96 V DC	up to 480Y/ 277 V AC 48/96 V DC	up to 125/ 250 V DC
Trip curves	Z, C, K	Z, C, K	Z, C, K	K	Z, K
Interrupt rating	10 kA	14 kA	14 kA	10 kA	14 kA
Auxiliary contacts	yes	yes	yes	yes	yes
Bell alarm	yes	yes	yes	yes	yes
Shunt trip	yes	yes	yes	yes	yes
Rotary handle mechanism	yes	yes	yes	yes	yes
LOTO adapter	yes	yes	yes	yes	yes
Busbars (cuttable)	yes	yes	yes	yes	yes
Busbars (fixed length)	yes	yes	yes	–	yes

	S800U	S800U-UCZ
Amperage	10–100 A	10–80 A
Voltage	240 V AC	600 V DC
Poles	1, 2, 3, 4	4 in series
Trip curves	Z (B), K	Z (K)
Short circuit interrupt rating	30/50 kA (1-/multipole)	
Auxiliary contacts	yes	–
Bell alarm	yes	–
Shunt trip	yes	–
Undervoltage release	yes	–
Rotary handle mechanism	yes	–
Motor operator	yes	–
Terminals	compression/ring tongue	compression



**ABB Products Proudly Distributed by Gross Automation.**

**Please call +1 (262) 252-1600 or email [sales@grossautomation.com](mailto:sales@grossautomation.com).**

# SU200M-C

Branch circuit protection — UL 489, CSA 22.2 No. 5

Number of poles	Rated current		Number of poles	Rated current	
	$I_n$ A	Cat. no.		$I_n$ A	Cat. no.
1	0.5	SU201M-C0.5	3	0.5	SU203M-C0.5
	1	SU201M-C1		1	SU203M-C1
	1.6	SU201M-C1.6		1.6	SU203M-C1.6
	2	SU201M-C2		2	SU203M-C2
	3	SU201M-C3		3	SU203M-C3
	4	SU201M-C4		4	SU203M-C4
	5	SU201M-C5		5	SU203M-C5
	6	SU201M-C6		6	SU203M-C6
	7	SU201M-C7		7	SU203M-C7
	8	SU201M-C8		8	SU203M-C8
	10	SU201M-C10		10	SU203M-C10
	13	SU201M-C13		13	SU203M-C13
	15	SU201M-C15		15	SU203M-C15
	16	SU201M-C16		16	SU203M-C16
	20	SU201M-C20		20	SU203M-C20
	25	SU201M-C25		25	SU203M-C25
	30	SU201M-C30		30	SU203M-C30
	2	0.5		SU202M-C0.5	4
1		SU202M-C1	1	SU204M-C1	
1.6		SU202M-C1.6	1.6	SU204M-C1.6	
2		SU202M-C2	2	SU204M-C2	
3		SU202M-C3	3	SU204M-C3	
4		SU202M-C4	4	SU204M-C4	
5		SU202M-C5	5	SU204M-C5	
6		SU202M-C6	6	SU204M-C6	
7		SU202M-C7	7	SU204M-C7	
8		SU202M-C8	8	SU204M-C8	
10		SU202M-C10	10	SU204M-C10	
13		SU202M-C13	13	SU204M-C13	
15		SU202M-C15	15	SU204M-C15	
16		SU202M-C16	16	SU204M-C16	
20		SU202M-C20	20	SU204M-C20	
25		SU202M-C25	25	SU204M-C25	
30		SU202M-C30	30	SU204M-C30	
32		SU202M-C32	32	SU204M-C32	
35	SU202M-C35	35	SU204M-C35		
40	SU202M-C40	40	SU204M-C40		
50	SU202M-C50	50	SU204M-C50		
60	SU202M-C60	60	SU204M-C60		
63	SU202M-C63	63	SU204M-C63		

Diagram

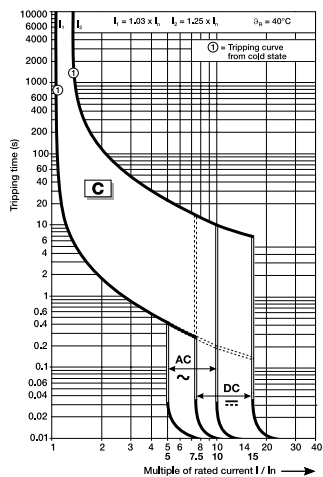

# SU200M-K

Branch circuit protection — UL 489, CSA 22.2 No. 5

Number of poles	Rated current		Number of poles	Rated current	
	$I_n$ A	Cat. no.		$I_n$ A	Cat. no.
1	0.2 0.3 0.5 0.75 1 1.6 2 3 4 5 6 7 8 10 13 15 16 20 25 30 32 35 40 50 60 63	SU201M-K0.2	3	0.2 0.3 0.5 0.75 1 1.6 2 3 4 5 6 7 8 10 13 15 16 20 25 30 32 35 40 50 60 63	SU203M-K0.2 SU203M-K0.3 SU203M-K0.5 SU203M-K0.75 SU203M-K1 SU203M-K1.6 SU203M-K2 SU203M-K3 SU203M-K4 SU203M-K5 SU203M-K6 SU203M-K7 SU203M-K8 SU203M-K10 SU203M-K13 SU203M-K15 SU203M-K16 SU203M-K20 SU203M-K25 SU203M-K30 SU203M-K32 SU203M-K35 SU203M-K40 SU203M-K50 SU203M-K60 SU203M-K63
		SU202M-K0.2			SU204M-K0.2
		SU202M-K0.3			SU204M-K0.3
		SU202M-K0.5			SU204M-K0.5
		SU202M-K0.75			SU204M-K0.75
		SU202M-K1			SU204M-K1
		SU202M-K1.6			SU204M-K1.6
		SU202M-K2			SU204M-K2
		SU202M-K3			SU204M-K3
		SU202M-K4			SU204M-K4
		SU202M-K5			SU204M-K5
		SU202M-K6			SU204M-K6
		SU202M-K7			SU204M-K7
		SU202M-K8			SU204M-K8
		SU202M-K10			SU204M-K10
		SU202M-K13			SU204M-K13
		SU202M-K15			SU204M-K15
		SU202M-K16			SU204M-K16
		SU202M-K20			SU204M-K20
SU202M-K25	SU204M-K25				
SU202M-K30	SU204M-K30				
SU202M-K32	SU204M-K32				
SU202M-K35	SU204M-K35				
SU202M-K40	SU204M-K40				
SU202M-K50	SU204M-K50				
SU202M-K60	SU204M-K60				
SU202M-K63	SU204M-K63				





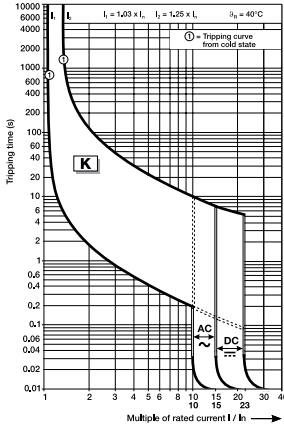

Diagram



# SU200M-Z

Branch circuit protection — UL 489, CSA 22.2 No. 5



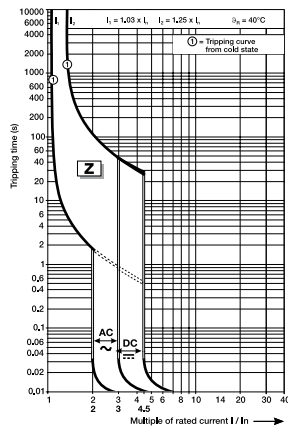

	Number of poles	Rated current		Number of poles	Rated current	
		$I_n$ A	Cat. no.		$I_n$ A	Cat. no.
	1	0.5	SU201M-Z0.5	3	0.5	SU203M-Z0.5
		1	SU201M-Z1		1	SU203M-Z1
		1.6	SU201M-Z1.6		1.6	SU203M-Z1.6
		2	SU201M-Z2		2	SU203M-Z2
		3	SU201M-Z3		3	SU203M-Z3
		4	SU201M-Z4		4	SU203M-Z4
		5	SU201M-Z5		5	SU203M-Z5
		6	SU201M-Z6		6	SU203M-Z6
		7	SU201M-Z7		7	SU203M-Z7
		8	SU201M-Z8		8	SU203M-Z8
		10	SU201M-Z10		10	SU203M-Z10
		13	SU201M-Z13		13	SU203M-Z13
		15	SU201M-Z15		15	SU203M-Z15
		16	SU201M-Z16		16	SU203M-Z16
		20	SU201M-Z20		20	SU203M-Z20
		25	SU201M-Z25		25	SU203M-Z25
		30	SU201M-Z30		30	SU203M-Z30
		32	SU201M-Z32		32	SU203M-Z32
		35	SU201M-Z35		35	SU203M-Z35
		40	SU201M-Z40		40	SU203M-Z40
50	SU201M-Z50	50	SU203M-Z50			
60	SU201M-Z60	60	SU203M-Z60			
63	SU201M-Z63	63	SU203M-Z63			
  	2	0.5	SU202M-Z0.5	4	0.5	SU204M-Z0.5
		1	SU202M-Z1		1	SU204M-Z1
		1.6	SU202M-Z1.6		1.6	SU204M-Z1.6
		2	SU202M-Z2		2	SU204M-Z2
		3	SU202M-Z3		3	SU204M-Z3
		4	SU202M-Z4		4	SU204M-Z4
		5	SU202M-Z5		5	SU204M-Z5
		6	SU202M-Z6		6	SU204M-Z6
		7	SU202M-Z7		7	SU204M-Z7
		8	SU202M-Z8		8	SU204M-Z8
		10	SU202M-Z10		10	SU204M-Z10
		13	SU202M-Z13		13	SU204M-Z13
		15	SU202M-Z15		15	SU204M-Z15
		16	SU202M-Z16		16	SU204M-Z16
		20	SU202M-Z20		20	SU204M-Z20
		25	SU202M-Z25		25	SU204M-Z25
		30	SU202M-Z30		30	SU204M-Z30
		32	SU202M-Z32		32	SU204M-Z32
		35	SU202M-Z35		35	SU204M-Z35
		40	SU202M-Z40		40	SU204M-Z40
50	SU202M-Z50	50	SU204M-Z50			
60	SU202M-Z60	60	SU204M-Z60			
63	SU202M-Z63	63	SU204M-Z63			

**Diagram**



# SU200ML-C

Branch circuit protection — UL 489, CSA 22.2 No. 5

	Number of poles	Rated current		Number of poles	Rated current				
		$I_n$ A	Cat. no.		$I_n$ A	Cat. no.			
	1	0.5	SU201ML-C0,5	3	0.5	SU203ML-C0,5			
		1	SU201ML-C1		1	SU203ML-C1			
		1.6	SU201ML-C1,6		1.6	SU203ML-C1,6			
		2	SU201ML-C2		2	SU203ML-C2			
		3	SU201ML-C3		3	SU203ML-C3			
		4	SU201ML-C4		4	SU203ML-C4			
		5	SU201ML-C5		5	SU203ML-C5			
		6	SU201ML-C6		6	SU203ML-C6			
		7	SU201ML-C7		7	SU203ML-C7			
		8	SU201ML-C8		8	SU203ML-C8			
		10	SU201ML-C10		10	SU203ML-C10			
		13	SU201ML-C13		13	SU203ML-C13			
		15	SU201ML-C15		15	SU203ML-C15			
		16	SU201ML-C16		16	SU203ML-C16			
	2	20	SU201ML-C20	20	20	SU203ML-C20			
		25	SU201ML-C25		25	SU203ML-C25			
		30	SU201ML-C30		30	SU203ML-C30			
		32	SU201ML-C32		32	SU203ML-C32			
		35	SU201ML-C35		35	SU203ML-C35			
		40	SU201ML-C40		40	SU203ML-C40			
		50	SU201ML-C50		50	SU203ML-C50			
		60	SU201ML-C60		60	SU203ML-C60			
		63	SU201ML-C63		63	SU203ML-C63			
			3		0.5	SU202ML-C0,5	4	0.5	SU204ML-C0,5
					1	SU202ML-C1		1	SU204ML-C1
					1.6	SU202ML-C1,6		1.6	SU204ML-C1,6
					2	SU202ML-C2		2	SU204ML-C2
					3	SU202ML-C3		3	SU204ML-C3
4	SU202ML-C4			4	SU204ML-C4				
5	SU202ML-C5			5	SU204ML-C5				
6	SU202ML-C6			6	SU204ML-C6				
7	SU202ML-C7			7	SU204ML-C7				
8	SU202ML-C8			8	SU204ML-C8				
10	SU202ML-C10			10	SU204ML-C10				
13	SU202ML-C13			13	SU204ML-C13				
15	SU202ML-C15			15	SU204ML-C15				
16	SU202ML-C16			16	SU204ML-C16				
	4	20	SU202ML-C20	20	20	SU204ML-C20			
		25	SU202ML-C25		25	SU204ML-C25			
		30	SU202ML-C30		30	SU204ML-C30			
		32	SU202ML-C32		32	SU204ML-C32			
		35	SU202ML-C35		35	SU204ML-C35			
		40	SU202ML-C40		40	SU204ML-C40			
		50	SU202ML-C50		50	SU204ML-C50			
		60	SU202ML-C60		60	SU204ML-C60			
		63	SU202ML-C63		63	SU204ML-C63			

Diagram

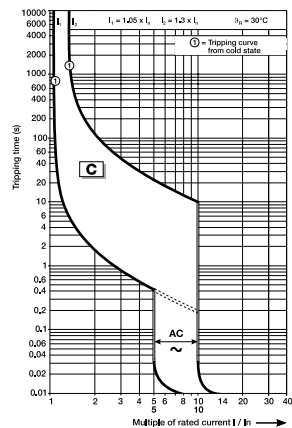

# SU200ML-K

Branch circuit protection — UL 489, CSA 22.2 No. 5

Number of poles	Rated current		Number of poles	Rated current	
	$I_n$ A	Cat. no.		$I_n$ A	Cat. no.
1	0.2 0.3 0.5 0.75 1 1.6 2 3 4 5 6 7 8 10 13 15 16 20 25 30 32 35 40 50 60 63	SU201ML-K0,2	3	0.2 0.3 0.5 0.75 1 1.6 2 3 4 5 6 7 8 10 13 15 16 20 25 30 32 35 40 50 60 63	SU203ML-K0,2 SU203ML-K0,3 SU203ML-K0,5 SU203ML-K0,75 SU203ML-K1 SU203ML-K1,6 SU203ML-K2 SU203ML-K3 SU203ML-K4 SU203ML-K5 SU203ML-K6 SU203ML-K7 SU203ML-K8 SU203ML-K10 SU203ML-K13 SU203ML-K15 SU203ML-K16 SU203ML-K20 SU203ML-K25 SU203ML-K30 SU203ML-K32 SU203ML-K35 SU203ML-K40 SU203ML-K50 SU203ML-K60 SU203ML-K63
		SU202ML-K0,2			SU204ML-K0,2
		SU202ML-K0,3			SU204ML-K0,3
		SU202ML-K0,5			SU204ML-K0,5
		SU202ML-K0,75			SU204ML-K0,75
		SU202ML-K1			SU204ML-K1
		SU202ML-K1,6			SU204ML-K1,6
		SU202ML-K2			SU204ML-K2
		SU202ML-K3			SU204ML-K3
		SU202ML-K4			SU204ML-K4
		SU202ML-K5			SU204ML-K5
		SU202ML-K6			SU204ML-K6
		SU202ML-K7			SU204ML-K7
		SU202ML-K8			SU204ML-K8
		SU202ML-K10			SU204ML-K10
		SU202ML-K13			SU204ML-K13
		SU202ML-K15			SU204ML-K15
SU202ML-K16	SU204ML-K16				
SU202ML-K20	SU204ML-K20				
SU202ML-K25	SU204ML-K25				
SU202ML-K30	SU204ML-K30				
SU202ML-K32	SU204ML-K32				
SU202ML-K35	SU204ML-K35				
SU202ML-K40	SU204ML-K40				
SU202ML-K50	SU204ML-K50				
SU202ML-K60	SU204ML-K60				
SU202ML-K63	SU204ML-K63				



Diagram

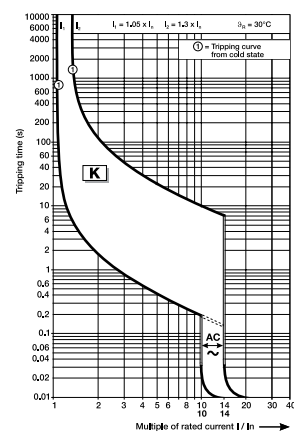

# SU200ML-Z

Branch circuit protection — UL 489, CSA 22.2 No. 5

Number of poles	Rated current		Number of poles	Rated current	
	$I_n$ A	Cat. no.		$I_n$ A	Cat. no.
1	0.5	SU201ML-Z0,5	3	0.5	SU203ML-Z0,5
	1	SU201ML-Z1		1	SU203ML-Z1
	1.6	SU201ML-Z1,6		1.0	SU203ML-Z1,6
	2	SU201ML-Z2		2	SU203ML-Z2
	3	SU201ML-Z3		3	SU203ML-Z3
	4	SU201ML-Z4		4	SU203ML-Z4
	5	SU201ML-Z5		5	SU203ML-Z5
	6	SU201ML-Z6		6	SU203ML-Z6
	7	SU201ML-Z7		7	SU203ML-Z7
	8	SU201ML-Z8		8	SU203ML-Z8
	10	SU201ML-Z10		10	SU203ML-Z10
	13	SU201ML-Z13		13	SU203ML-Z13
	15	SU201ML-Z15		15	SU203ML-Z15
	16	SU201ML-Z16		16	SU203ML-Z16
	20	SU201ML-Z20		20	SU203ML-Z20
	25	SU201ML-Z25		25	SU203ML-Z25
	30	SU201ML-Z30		30	SU203ML-Z30
	32	SU201ML-Z32		32	SU203ML-Z32
	35	SU201ML-Z35		35	SU203ML-Z35
40	SU201ML-Z40	40	SU203ML-Z40		
50	SU201ML-Z50	50	SU203ML-Z50		
60	SU201ML-Z60	60	SU203ML-Z60		
63	SU201ML-Z63	63	SU203ML-Z63		
2	0.5	SU202ML-Z0,5	4	0.5	SU204ML-Z0,5
	1	SU202ML-Z1		1	SU204ML-Z1
	1.6	SU202ML-Z1,6		1.6	SU204ML-Z1,6
	2	SU202ML-Z2		2	SU204ML-Z2
	3	SU202ML-Z3		3	SU204ML-Z3
	4	SU202ML-Z4		4	SU204ML-Z4
	5	SU202ML-Z5		5	SU204ML-Z5
	6	SU202ML-Z6		6	SU204ML-Z6
	7	SU202ML-Z7		7	SU204ML-Z7
	8	SU202ML-Z8		8	SU204ML-Z8
	10	SU202ML-Z10		10	SU204ML-Z10
	13	SU202ML-Z13		13	SU204ML-Z13
	15	SU202ML-Z15		15	SU204ML-Z15
	16	SU202ML-Z16		16	SU204ML-Z16
	20	SU202ML-Z20		20	SU204ML-Z20
	25	SU202ML-Z25		25	SU204ML-Z25
	30	SU202ML-Z30		30	SU204ML-Z30
	32	SU202ML-Z32		32	SU204ML-Z32
	35	SU202ML-Z35		35	SU204ML-Z35
40	SU202ML-Z40	40	SU204ML-Z40		
50	SU202ML-Z50	50	SU204ML-Z50		
60	SU202ML-Z60	60	SU204ML-Z60		
63	SU202ML-Z63	63	SU204ML-Z63		

Diagram

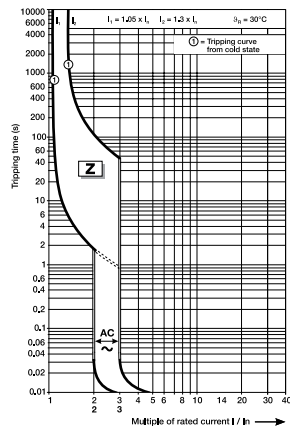

# SUP200M-C

Branch circuit protection — UL 489, CSA 22.2 No. 5

Number of poles	Rated current		Number of poles	Rated current	
	$I_n$ A	Cat. no.		$I_n$ A	Cat. no.
1	1	SUP201M-C1	3	1	SUP203M-C1
	1.6	SUP201M-C1.6		1.6	SUP203M-C1.6
	2	SUP201M-C2		2	SUP203M-C2
	3	SUP201M-C3		3	SUP203M-C3
	4	SUP201M-C4		4	SUP203M-C4
	5	SUP201M-C5		5	SUP203M-C5
	6	SUP201M-C6		6	SUP203M-C6
	7	SUP201M-C7		7	SUP203M-C7
	8	SUP201M-C8		8	SUP203M-C8
	10	SUP201M-C10		10	SUP203M-C10
	13	SUP201M-C13		13	SUP203M-C13
	15	SUP201M-C15		15	SUP203M-C15
	16	SUP201M-C16		16	SUP203M-C16
	20	SUP201M-C20		20	SUP203M-C20
	25	SUP201M-C25		25	SUP203M-C25
	2	1		SUP202M-C1	3
1.6		SUP202M-C1.6	1.6	SUP203M-C1.6	
2		SUP202M-C2	2	SUP203M-C2	
3		SUP202M-C3	3	SUP203M-C3	
4		SUP202M-C4	4	SUP203M-C4	
5		SUP202M-C5	5	SUP203M-C5	
6		SUP202M-C6	6	SUP203M-C6	
7		SUP202M-C7	7	SUP203M-C7	
8		SUP202M-C8	8	SUP203M-C8	
10		SUP202M-C10	10	SUP203M-C10	
13		SUP202M-C13	13	SUP203M-C13	
15		SUP202M-C15	15	SUP203M-C15	
16		SUP202M-C16	16	SUP203M-C16	
20		SUP202M-C20	20	SUP203M-C20	
25		SUP202M-C25	25	SUP203M-C25	
30		SUP202M-C30	30	SUP203M-C30	
32	SUP202M-C32	32	SUP203M-C32		
35	SUP202M-C35	35	SUP203M-C35		
40	SUP202M-C40	40	SUP203M-C40		



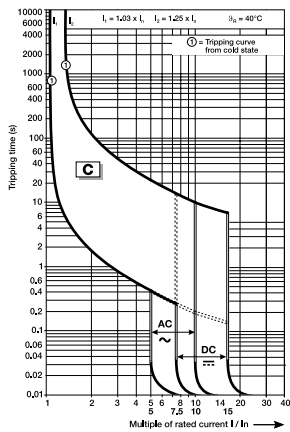

**Diagram**



# SUP200M-K

Branch circuit protection — UL 489, CSA 22.2 No. 5

Number of poles	Rated current		Cat. no.	Number of poles	Rated current		
	$I_n$ A				$I_n$ A	Cat. no.	
	1	1	SUP201M-K1	3	1	SUP203M-K1	
		1.6	SUP201M-K1.6			1.6	SUP203M-K1.6
		2	SUP201M-K2			2	SUP203M-K2
		3	SUP201M-K3			3	SUP203M-K3
		4	SUP201M-K4			4	SUP203M-K4
		5	SUP201M-K5			5	SUP203M-K5
		6	SUP201M-K6			6	SUP203M-K6
		7	SUP201M-K7			7	SUP203M-K7
		8	SUP201M-K8			8	SUP203M-K8
		10	SUP201M-K10			10	SUP203M-K10
		13	SUP201M-K13			13	SUP203M-K13
		15	SUP201M-K15			15	SUP203M-K15
		16	SUP201M-K16			16	SUP203M-K16
		20	SUP201M-K20			20	SUP203M-K20
			2			1	SUP202M-K1
1.6	SUP202M-K1.6			1.6	SUP203M-K1.6		
2	SUP202M-K2			2	SUP203M-K2		
3	SUP202M-K3			3	SUP203M-K3		
4	SUP202M-K4			4	SUP203M-K4		
5	SUP202M-K5			5	SUP203M-K5		
6	SUP202M-K6			6	SUP203M-K6		
7	SUP202M-K7			7	SUP203M-K7		
8	SUP202M-K8			8	SUP203M-K8		
10	SUP202M-K10			10	SUP203M-K10		
13	SUP202M-K13			13	SUP203M-K13		
15	SUP202M-K15			15	SUP203M-K15		
16	SUP202M-K16			16	SUP203M-K16		
20	SUP202M-K20			20	SUP203M-K20		
	3			1	SUP203M-K1	3	1
		1.6	SUP203M-K1.6	1.6	SUP203M-K1.6		
		2	SUP203M-K2	2	SUP203M-K2		
		3	SUP203M-K3	3	SUP203M-K3		
		4	SUP203M-K4	4	SUP203M-K4		
		5	SUP203M-K5	5	SUP203M-K5		
		6	SUP203M-K6	6	SUP203M-K6		
		7	SUP203M-K7	7	SUP203M-K7		
		8	SUP203M-K8	8	SUP203M-K8		
		10	SUP203M-K10	10	SUP203M-K10		
		13	SUP203M-K13	13	SUP203M-K13		
		15	SUP203M-K15	15	SUP203M-K15		
		16	SUP203M-K16	16	SUP203M-K16		
		20	SUP203M-K20	20	SUP203M-K20		

**Diagram**

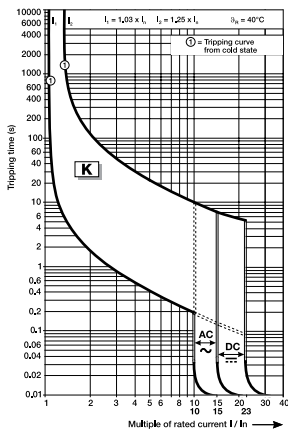

# SUP200M-Z

Branch circuit protection — UL 489, CSA 22.2 No. 5

Number of poles	Rated current		Cat. no.	Number of poles	Rated current		
	$I_n$	A			$I_n$	A	Cat. no.
1	1		SUP201M-Z1	3	1		SUP203M-Z1
	1.6		SUP201M-Z1.6		1.6		SUP203M-Z1.6
	2		SUP201M-Z2		2		SUP203M-Z2
	3		SUP201M-Z3		3		SUP203M-Z3
	4		SUP201M-Z4		4		SUP203M-Z4
	5		SUP201M-Z5		5		SUP203M-Z5
	6		SUP201M-Z6		6		SUP203M-Z6
	7		SUP201M-Z7		7		SUP203M-Z7
	8		SUP201M-Z8		8		SUP203M-Z8
	10		SUP201M-Z10		10		SUP203M-Z10
	15		SUP201M-Z15		15		SUP203M-Z15
	16		SUP201M-Z16		16		SUP203M-Z16
	20		SUP201M-Z20		20		SUP203M-Z20
	25		SUP201M-Z25		25		SUP203M-Z25
	30		SUP201M-Z30		30		SUP203M-Z30
	32		SUP201M-Z32		32		SUP203M-Z32
35		SUP201M-Z35	35		SUP203M-Z35		
40		SUP201M-Z40	40		SUP203M-Z40		
2	1		SUP202M-Z1				
	1.6		SUP202M-Z1.6				
	2		SUP202M-Z2				
	3		SUP202M-Z3				
	4		SUP202M-Z4				
	5		SUP202M-Z5				
	6		SUP202M-Z6				
	7		SUP202M-Z7				
	8		SUP202M-Z8				
	10		SUP202M-Z10				
	15		SUP202M-Z15				
	16		SUP202M-Z16				
	20		SUP202M-Z20				
	25		SUP202M-Z25				
	30		SUP202M-Z30				
	32		SUP202M-Z32				
35		SUP202M-Z35					
40		SUP202M-Z40					





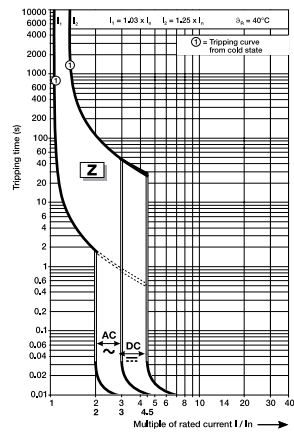

**Diagram**



# SU200MR-K with ring tongue terminals

Branch circuit protection — UL 489, CSA 22.2 No. 5

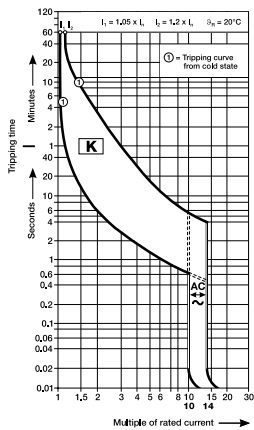

1				3			
Number of poles	Rated current $I_n$ A	Cat. no.		Number of poles	Rated current $I_n$ A	Cat. no.	
	0.2	SU201MR-K0.2			0.2	SU203MR-K0.2	
	0.3	SU201MR-K0.3			0.3	SU203MR-K0.3	
	0.5	SU201MR-K0.5			0.5	SU203MR-K0.5	
	0.75	SU201MR-K0.75			0.75	SU203MR-K0.75	
	1	SU201MR-K1			1	SU203MR-K1	
	1.6	SU201MR-K1.6			1.6	SU203MR-K1.6	
	2	SU201MR-K2			2	SU203MR-K2	
	3	SU201MR-K3			3	SU203MR-K3	
	4	SU201MR-K4			4	SU203MR-K4	
	5	SU201MR-K5			5	SU203MR-K5	
	6	SU201MR-K6			6	SU203MR-K6	
	8	SU201MR-K8			8	SU203MR-K8	
	10	SU201MR-K10			10	SU203MR-K10	
	13	SU201MR-K13			13	SU203MR-K13	
	15	SU201MR-K15			15	SU203MR-K15	
	16	SU201MR-K16			16	SU203MR-K16	
20	SU201MR-K20		20	SU203MR-K20			
25	SU201MR-K25		25	SU203MR-K25			
30	SU201MR-K30		30	SU203MR-K30			
32	SU201MR-K32		32	SU203MR-K32			
35	SU201MR-K35		35	SU203MR-K35			
40	SU201MR-K40		40	SU203MR-K40			
50	SU201MR-K50		50	SU203MR-K50			
60	SU201MR-K60		60	SU203MR-K60			
63	SU201MR-K63		63	SU203MR-K63			
<hr/>				<hr/>			
2				4			
	0.2	SU202MR-K0.2			0.2	SU204MR-K0.2	
	0.3	SU202MR-K0.3			0.3	SU204MR-K0.3	
	0.5	SU202MR-K0.5			0.5	SU204MR-K0.5	
	0.75	SU202MR-K0.75			0.75	SU204MR-K0.75	
	1	SU202MR-K1			1	SU204MR-K1	
	1.6	SU202MR-K1.6			1.6	SU204MR-K1.6	
	2	SU202MR-K2			2	SU204MR-K2	
	3	SU202MR-K3			3	SU204MR-K3	
	4	SU202MR-K4			4	SU204MR-K4	
	5	SU202MR-K5			5	SU204MR-K5	
	6	SU202MR-K6			6	SU204MR-K6	
	8	SU202MR-K8			8	SU204MR-K8	
	10	SU202MR-K10			10	SU204MR-K10	
	13	SU202MR-K13			13	SU204MR-K13	
	15	SU202MR-K15			15	SU204MR-K15	
	16	SU202MR-K16			16	SU204MR-K16	
20	SU202MR-K20		20	SU204MR-K20			
25	SU202MR-K25		25	SU204MR-K25			
30	SU202MR-K30		30	SU204MR-K30			
32	SU202MR-K32		32	SU204MR-K32			
35	SU202MR-K35		35	SU204MR-K35			
40	SU202MR-K40		40	SU204MR-K40			
50	SU202MR-K50		50	SU204MR-K50			
60	SU202MR-K60		60	SU204MR-K60			
63	SU202MR-K63		63	SU204MR-K63			

Diagram



# S200UDC-K

Branch circuit protection — UL 489, CSA 22.2 No. 5

	Number of poles	Rated current		Cat. no.
		$I_n$	A	
 	1	1		S201UDC-K1
		1.6		S201UDC-K1.6
		2		S201UDC-K2
		3		S201UDC-K3
		4		S201UDC-K4
		5		S201UDC-K5
		6		S201UDC-K6
		8		S201UDC-K8
		10		S201UDC-K10
		13		S201UDC-K13
		15		S201UDC-K15
		16		S201UDC-K16
		20		S201UDC-K20
		25		S201UDC-K25
		30		S201UDC-K30
32		S201UDC-K32		
40		S201UDC-K40		
50		S201UDC-K50		
60		S201UDC-K60		
63		S201UDC-K63		
	2	1		S202UDC-K1
		1.6		S202UDC-K1.6
		2		S202UDC-K2
		3		S202UDC-K3
		4		S202UDC-K4
		5		S202UDC-K5
		6		S202UDC-K6
		8		S202UDC-K8
		10		S202UDC-K10
		13		S202UDC-K13
		15		S202UDC-K15
		16		S202UDC-K16
		20		S202UDC-K20
		25		S202UDC-K25
		30		S202UDC-K30
32		S202UDC-K32		
40		S202UDC-K40		
50		S202UDC-K50		
60		S202UDC-K60		
63		S202UDC-K63		

**Diagram**

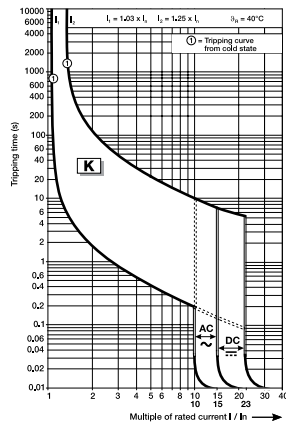

Note: Standard UL 489 (only DC; please note polarity of device).

# S200UDC-Z

Branch circuit protection — UL 489, CSA 22.2 No. 5

	Number of poles	Rated current		Cat. no.
		$I_n$	A	
	1	1	1	S201UDC-Z1
		1.6	1.6	S201UDC-Z1.6
		2	2	S201UDC-Z2
		3	3	S201UDC-Z3
		4	4	S201UDC-Z4
		5	5	S201UDC-Z5
		6	6	S201UDC-Z6
		8	8	S201UDC-Z8
		10	10	S201UDC-Z10
		13	13	S201UDC-Z13
		15	15	S201UDC-Z15
		16	16	S201UDC-Z16
		20	20	S201UDC-Z20
		25	25	S201UDC-Z25
		30	30	S201UDC-Z30
		32	32	S201UDC-Z32
		40	40	S201UDC-Z40
		50	50	S201UDC-Z50
		60	60	S201UDC-Z60
		63	63	S201UDC-Z63
	2	1	1	S202UDC-Z1
		1.6	1.6	S202UDC-Z1.6
		2	2	S202UDC-Z2
		3	3	S202UDC-Z3
		4	4	S202UDC-Z4
		5	5	S202UDC-Z5
		6	6	S202UDC-Z6
		8	8	S202UDC-Z8
		10	10	S202UDC-Z10
		13	13	S202UDC-Z13
		15	15	S202UDC-Z15
		16	16	S202UDC-Z16
		20	20	S202UDC-Z20
		25	25	S202UDC-Z25
30	30	S202UDC-Z30		
32	32	S202UDC-Z32		
40	40	S202UDC-Z40		
50	50	S202UDC-Z50		
60	60	S202UDC-Z60		
63	63	S202UDC-Z63		



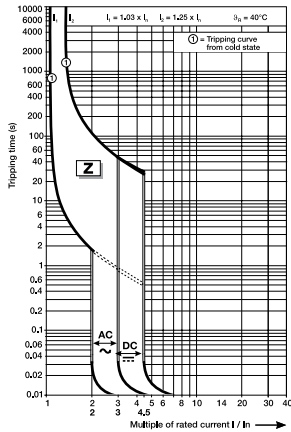

Diagram



Note: Standard UL 489 (only DC; please note polarity of device).

## S800U-K, 240 V AC

Branch circuit protection — UL 489

	Number of poles	Rated current		Number of poles	Rated current	
		$I_n$ A	Cat. no.		$I_n$ A	Cat. no.
	1	10	S801U-K10	3	10	S803U-K10
		15	S801U-K15		15	S803U-K15
		20	S801U-K20		20	S803U-K20
		25	S801U-K25		25	S803U-K25
		30	S801U-K30		30	S803U-K30
		40	S801U-K40		40	S803U-K40
		50	S801U-K50		50	S803U-K50
		60	S801U-K60		60	S803U-K60
		70	S801U-K70		70	S803U-K70
		80	S801U-K80		80	S803U-K80
	2	10	S802U-K10	4	10	S804U-K10
		15	S802U-K15		15	S804U-K15
		20	S802U-K20		20	S804U-K20
		25	S802U-K25		25	S804U-K25
		30	S802U-K30		30	S804U-K30
		40	S802U-K40		40	S804U-K40
		50	S802U-K50		50	S804U-K50
		60	S802U-K60		60	S804U-K60
		70	S802U-K70		70	S804U-K70
		80	S802U-K80		80	S804U-K80
	3	10	S803U-K10	4	10	S804U-K10
		15	S803U-K15		15	S804U-K15
		20	S803U-K20		20	S804U-K20
		25	S803U-K25		25	S804U-K25
		30	S803U-K30		30	S804U-K30
		40	S803U-K40		40	S804U-K40
		50	S803U-K50		50	S804U-K50
		60	S803U-K60		60	S804U-K60
		70	S803U-K70		70	S804U-K70
		80	S803U-K80		80	S804U-K80
	4	10	S804U-K10	4	10	S804U-K10
		15	S804U-K15		15	S804U-K15
		20	S804U-K20		20	S804U-K20
		25	S804U-K25		25	S804U-K25
		30	S804U-K30		30	S804U-K30
		40	S804U-K40		40	S804U-K40
		50	S804U-K50		50	S804U-K50
		60	S804U-K60		60	S804U-K60
		70	S804U-K70		70	S804U-K70
		80	S804U-K80		80	S804U-K80



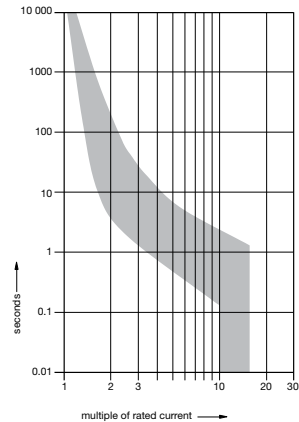

**Diagram**



Available with ring tongue terminals upon request.

## S800U-Z, 240 V AC

Branch circuit protection — UL 489

	Number of poles	Rated current		Number of poles	Rated current	
		$I_n$ A	Cat. no.		$I_n$ A	Cat. no.
	1	10	S801U-Z10	3	10	S803U-Z10
		15	S801U-Z15		15	S803U-Z15
		20	S801U-Z20		20	S803U-Z20
		25	S801U-Z25		25	S803U-Z25
		30	S801U-Z30		30	S803U-Z30
		40	S801U-Z40		40	S803U-Z40
		50	S801U-Z50		50	S803U-Z50
		60	S801U-Z60		60	S803U-Z60
		70	S801U-Z70		70	S803U-Z70
		80	S801U-Z80		80	S803U-Z80
	2	10	S802U-Z10	4	10	S804U-Z10
		15	S802U-Z15		15	S804U-Z15
		20	S802U-Z20		20	S804U-Z20
		25	S802U-Z25		25	S804U-Z25
		30	S802U-Z30		30	S804U-Z30
		40	S802U-Z40		40	S804U-Z40
		50	S802U-Z50		50	S804U-Z50
		60	S802U-Z60		60	S804U-Z60
		70	S802U-Z70		70	S804U-Z70
		80	S802U-Z80		80	S804U-Z80
	3	10	S803U-Z10	4	10	S804U-Z10
		15	S803U-Z15		15	S804U-Z15
		20	S803U-Z20		20	S804U-Z20
		25	S803U-Z25		25	S804U-Z25
		30	S803U-Z30		30	S804U-Z30
		40	S803U-Z40		40	S804U-Z40
		50	S803U-Z50		50	S804U-Z50
		60	S803U-Z60		60	S804U-Z60
		70	S803U-Z70		70	S804U-Z70
		80	S803U-Z80		80	S804U-Z80
	4	10	S804U-Z10	4	10	S804U-Z10
		15	S804U-Z15		15	S804U-Z15
		20	S804U-Z20		20	S804U-Z20
		25	S804U-Z25		25	S804U-Z25
		30	S804U-Z30		30	S804U-Z30
		40	S804U-Z40		40	S804U-Z40
		50	S804U-Z50		50	S804U-Z50
		60	S804U-Z60		60	S804U-Z60
		70	S804U-Z70		70	S804U-Z70
		80	S804U-Z80		80	S804U-Z80

**Diagram**

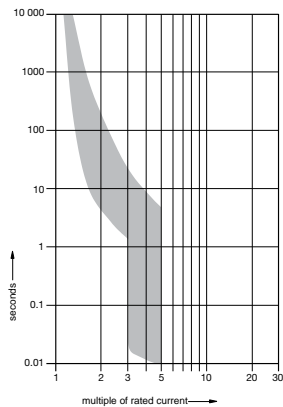

Available with ring tongue terminals upon request.

---

## S804U-UCZ

---

### Ordering information



Rated current (A)	Cat. no.
10	S804U-UCZ10
15	S804U-UCZ15
20	S804U-UCZ20
25	S804U-UCZ25
30	S804U-UCZ30
40	S804U-UCZ40
50	S804U-UCZ50
60	S804U-UCZ60
70	S804U-UCZ70
80	S804U-UCZ80

---

## Accessories

SU200M, SU200ML, SUP200M, SU200MR and S200UDC — UL 489, CSA 22.2 No. 5

### Auxiliary contacts

The auxiliary contacts will signal whether the breaker is in the on or off position.

	Description	Cat. no.
	For field mounting: right side	S2C-H6RU

### Shunt trip

For remote tripping of breaker, a shunt trip device can be added to the MCB. The solenoid device opens the breaker after control voltage is applied.

	Description	Cat. no.
	For field mounting: right side 12...60 V AC/DC	S2C-A1U
	For field mounting: right side 110...415 V AC 110...250 V DC	S2C-A2U

Note: For shafts and handles, refer to parts in the Disconnect Switch and MCCB section.

### Bell alarm

The bell alarm includes a set of contacts that will only signal when the breaker has tripped. Typically, the contacts would be connected to an alarm or bell to signal the operator that an over-current trip has occurred. The bell alarm also includes a test button for testing the alarm contacts without opening the breaker.

	Description	Cat. no.
	For field mounting: right side	S2C-S6RU

### Possible mounting arrangements of MCB accessories

#### Legend

Auxiliary contact	H
Bell alarm/auxiliary contact	S/H
Bell alarm/auxiliary contact used as auxiliary contact	S/H (H)
Shunt trip	ST

Note: Right-hand mount accessories cannot be used in conjunction with S2C-DH, rotary operating mechanism.

#### Diagram

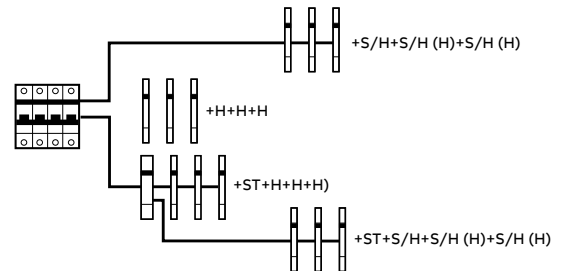

## Accessories

SU200M, SU200ML, SUP200M, SU200MR and S200UDC — UL 489, CSA 22.2 No. 5

### Rotary operating mechanism

For through-the-door operation with a pistol or selector handle in applications where the breaker is also used as a main disconnecting means (disconnect switch).



#### Description

Rotary handle mechanism can be used with any 5 or 6 mm shaft and any kind of handle (for example, selector handles, pistol handles)

#### Cat. no.

S2C-DH

## Lockout/tag out device

#### Product description

For single-pole MCBs

For multi-pole MCBs

#### Cat. no.

S2C-LOTO-S

S2C-LOTO-M

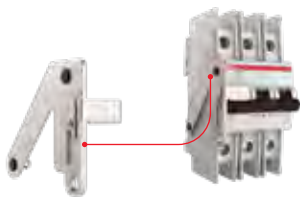

For all MCBs

S2C-LOTO-I

**Accessories**

SU200M, SU200ML, SUP200M, SU200MR and S200UDC — UL 489, CSA 22.2 No. 5

**Connection drawings**

**Bell alarm S2C-S6RU**

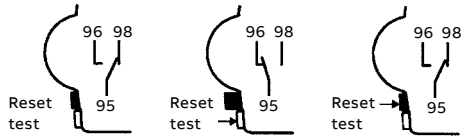

In ON and OFF position after hand operation

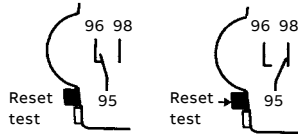

In OFF position after tripping

**Auxiliary contact S2C-H6RU**

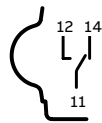

Auxiliary contact in ON position

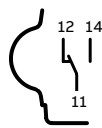

Auxiliary contact in OFF position

**Shunt trip S2C-A...U**

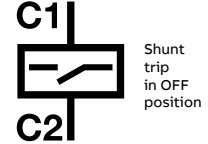

**Mounting**

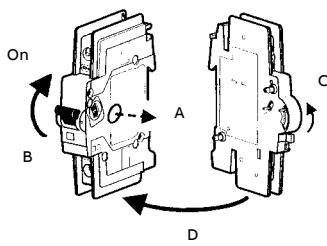

Addition of a S2C-H6RU auxiliary contact

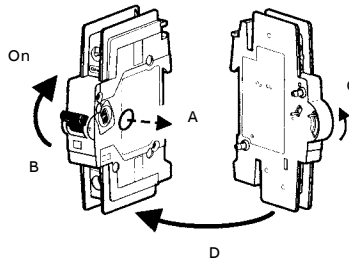

Addition of a S2C-S6RU bell alarm contact

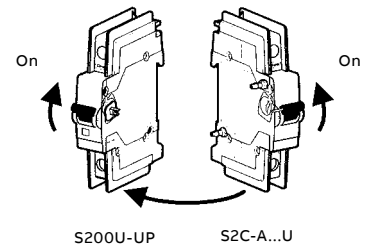

Addition of a S2C-A...U shunt trip

**Accessories**

SU200MR — UL 489, CSA 22.2 No. 5

**SU200MR Instructions for use**

**Ring Tongue Terminal, Special purpose - Not for general use**

**Installation Instructions**

Please insert or withdraw the cable lug only when the screw is completely open.

Please make sure that the terminal screw penetrates the ring lug hole properly and completely during tightening.

Please ensure that the screw is securely tightened before applying any mechanical force on the cable / cable lug.

Do not apply abnormal downward pressure on the screw during tightening or loosening of the screw.

Please follow the Ring Tongue Details on the rear of this sheet.

**Ring Tongue Details**

Only  or  ring cable lugs	Insulated only  Rated voltage 480Y/277 V AC	A	B	C
	Insulated only  Rated voltage 240/240 V AC	A	B	C
		max. 11.0 mm (0.43")	max. 12.2 mm (0.48")	Suitable for M5 (0.20")
		max. 14.0 mm (0.55")	max. 12.2 mm (0.48")	Suitable for M5 (0.20")

PZ 2 Torque: 2.8 Nm (25lb-in)

CU only  
 60/75°C  
 (140/167°F)

max. 2.0 mm  
 (0.08")

## Accessories

SU200M, SU200ML, SUP200M, SU200MR and S200UDC — UL 489, CSA 22.2 No. 5

**Busbars for use with SU200M, S200UDC, SU200ML and SUP200M, cannot be cut**



	Amp rating*	Number of poles	Phases	Busbar length (mm)	Cat. no.
	80/115	6	1	103.2	PS1/6/16BP
		12	1	208.8	PS1/12/16BP
		18	1	314.4	PS1/18/16BP
	80/115	6	2	103.2	PS2/6/16BP
		12	2	208.8	PS2/12/16BP
		18	2	314.4	PS2/18/16BP
	80/115	6	3	103.2	PS3/6/16BP
		12	3	208.8	PS3/12/16BP
		18	3	314.4	PS3/18/16BP

\*Depending on enclosure size

### Busbar tooth covers for BS...BP (UL 489)

	Description	Cat. no.
	Covers three unused poles of busbar	BSK-BP

### Feeder terminals for PS...BP (UL 489)

	Description	Cat. no.
	Terminal, insulated with pin contact	AST35/15BP
	Feeder terminal, single-pole terminal, can be mounted side by side, feed on the pin of the busbar	SZ-ESK BP

### Busbars PS...BP-C for use with SU200M, SU200ML, SUP200M and S200UDC, can be cut to length

	Number of phases	Phase sequence	Cat. no.
	1	L1-L1-L1...	PS1/57/25BP-C
		L1-Aux (free)-L1-Aux (free)...1	PS1/37/25HBP-C
	2	L1-L2-L1-L2...	PS2/56/25BP-C
		L1-L2-Aux (free)-L1-L2-Aux (free)...1	PS2/46/25HBP-C
	3	L1-L2-L3-L1-L2-L3...	PS3/57/25BP-C
		L1-L2-L3-Aux (free)-L1-L2-L3-Aux (free)...1	PS3/48/25HBP-C
		L1-Aux (free)-L2-Aux (free)-L3-Aux (free)...1	PS3/39/25HBP-C

<sup>1)</sup> For devices with auxiliary contact (half module) after each phase sequence

### Accessories

Description	Cat. no.
Tooth covers, for 3 pins	BSK BP-C
End caps	PS-END 3 BP-C
Feeder terminal	AST 35/58 BP-C

## Accessories

SU200M, SU200ML, SUP200M, SU200MR and S200UDC — UL 489, CSA 22.2 No. 5

Busbars for SU200MR, can be cut to length

Busbars PS...BP-CR for use with end caps PS-END 3 BP-C

	Number of phases	Phase sequence	Number of pins pc.	Cross section mm <sup>2</sup>	Cat. no.
	1	L1-L1-L1...	57	25	PS1/57/25BP-CR
		L1-Aux (free)-L1-Aux (free)...1)	37	25	PS1/37/25HBP-CR
	2	L1-L2-L1-L2...	56	25	PS2/56/25BP-CR
		L1-L2-Aux (free)-L1-L2-Aux (free)...1)	46	25	PS2/46/25HBP-CR
	3	L1-L2-L3-L1-L2-L3...	57	25	PS3/57/25BP-CR
		L1-L2-L3-Aux (free)-L1-L2-L3-Aux (free)...1)	48	25	PS3/48/25HBP-CR
	L1-Aux (free)-L2-Aux (free)-L3-Aux (free)...1)	39	25	PS3/39/25HBP-CR	

<sup>1)</sup> For devices with auxiliary contact (half module) after each phase sequence

## Accessories

Description	Cat. no.
Tooth covers, for 3 pins	BSK BP-CR
End caps	PS-END 3 BP-C

### Filling piece

For heat dissipation of closely mounted devices that generate much heat. Width 8.75 mm, as spacer, two different heights, breakable, for DIN rails according to DIN EN 60 715, 35 x 7.5 mm.

Product description	Weight 1 piece kg	Pack unit pc.	Cat. no.
	0.01	25	SZ-FST 2

## Accessories

SU200M, SU200ML, SUP200M, SU200MR and S200UDC — UL 489, CSA 22.2 No. 5

### False poles

		Weight 1 piece kg	Pack unit pc.	Cat. no.
	False pole — 1 module	0.01	100	FP1
	Support for false pole	0.012	10	SFP

### Flanges

		Weight 1 piece kg	Pack unit pc.	Cat. no.
	Flange/front plate mounting 1 module — IP40	0.040	1	ME 1
	Flange/front plate mounting 2 modules — IP40	0.045	1	ME 2
	Flange/front plate mounting 3 modules — IP40	0.055	1	ME 3
	Flange/front plate mounting 4 modules — IP40	0.060	1	ME 4
	Flange/front plate mounting 6 modules — IP40	0.070	1	ME 6
	Flange/front plate mounting 8 modules — IP40	0.080	1	ME 8

Flange for both UL 489 and UL 1077 MCBs

## S800W-RSU Remote switching unit

UL 489

### Remote switching unit

	Description	Cat. no.
S800W-RSU (breaker is not included)	Remote switching unit	S800W-RSU



### S800-RSU cable including plug

	Description	Cat. no.
	3 meter cable 0.5 mm <sup>2</sup> (20 AWG) including 10- pole Micro-Fit 3.0™ plug	S800-RSU-CP



### Key features

- The remote switching unit S800W-RSU has a brushless high precision DC motor to ensure fast remote control operation
- Low power consumption
- Short switching times
- The S800W-RSU is mounted on any multi-pole S800 high-performance MCB
- Installation and wiring can be field installable
- The connection is done by a 10-pole Micro-Fit 3.0™ (not included in delivery)
- The S800W-RSU can be operated by a standard pushbutton or drive by a PLC

### Switching times

- OFF -> ON <<500 ms  
from signal to contact closing
- ON -> OFF <<250 ms  
from signal to contact opening
- TRIP -> OFF -> ON <<1500 ms  
from signal to contact closing

### Safety intelligence

- Inputs are deactivated when detecting manual use
- All outputs become active when spindle is rotated more than 360°
- S800W-RSU is locked for five minutes after three switching attempts leading to a trip
- Manual switch off possible for three- and four-pole devices

### Technical specifications

<b>Operational voltage</b>	<b>24 V DC</b>
Current consumption $I_{ms}$	2, 5
Standby current $I_{standby}$	< 50 mA
Switching time OFF-ON	< 500 msec
Switching time ON-OFF	<250 msec
Ambient operation temperature	-25 °C to 70 °C
Number of switching operations	10.000
Maximum cable lengths (20 AWG/0.5 mm <sup>2</sup> )	10 m
Degree of protection (mounted)	IP2
Weight	0.661387 lb.
Connection	10-pole Micro-Fit 3.0™

### Diagrams

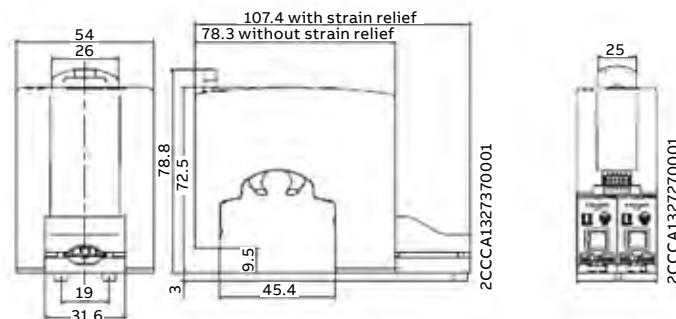

Approximate dimensions shown are in mm.

## Accessories

### S800U

#### Shunt trip

For remote tripping of breaker, a shunt trip device can be added to the MCB. The device opens the breaker after control voltage is applied.

	Description (for field mounting, left side)	Cat. no.
	Shunt operation release 24 V AC/DC	S800-SOR24
	Shunt operation release 48–130 V AC/DC	S800-SOR130
	Shunt operation release 110–250 V AC/DC	S800-SOR250

#### Under-voltage release

When control voltage drops below approximately 50 percent of rated voltage, the UVR opens the breaker. The breaker cannot be operated unless proper control voltage is first applied to the UVR coil.

	Description	Cat. no.
	Under-voltage release 24–36 V AC/DC	S800-UVR36
	Under-voltage release 48–60 V AC/DC	S800-UVR60
	Under-voltage release 110–130 V AC/DC	S800-UVR130
	Under-voltage release 220–250 V AC/DC	S800-UVR250

#### Auxiliary contacts

The auxiliary contacts will signal whether the breaker is in the ON or OFF position.

	Description	Cat. no.
	Auxiliary contact	S800-AUX

#### Bell alarm

The bell alarm includes a set of contacts that will only signal when the breaker has tripped. Typically, the contacts would be connected to an alarm or bell to signal the operator that an overcurrent trip has occurred. The bell alarm also includes a test button for testing the alarm contacts without opening the breaker.

	Cat. no.
	S800-AUX/ALT

#### Ring tongue adapter

	Cat. no.
	S800-RT2125

## Accessories

S800U

### Rotary operating mechanism

Allows "through-the-door" operation.

	Description	Cat. no.
	Handle mechanism	S800-RD

	Description	Cat. no.
	Gray rotary handle	S800-RHE-H

### UL locking device

	Description	Cat. no.
	Red rotary handle	S800-RHE-EM

	Description	Cat. no.
	Shaft extension	S800-RHE-S

	Description	Cat. no.
	Padlock not included	S800U-PLL

## Technical specifications

SU200M, SU200ML, SUP200M, SU200MR and S200UDC — UL 489, CSA 22.2 No. 5

### Technical specifications

	SU200M	SU200ML	SUP200M	SU200MR	S200UDC
Standards	UL 489, CSA 22.2 No. 5, IEC 60947-2				
UL File number	E212323				
No. of poles	1, 2, 3, 4	1, 2, 3, 4	1, 2, 3	1, 2, 3, 4	1, 2
Trip curves	C, K, Z	C, K, Z	C, K, Z	K	Z, K
Rated current	up to 63 A	0.2 to 63 A	up to 40 A	up to 63 A	up to 63 A
Rated voltage	480Y/277 V AC up to 40 A (Z and C trip curves)	230 V	480Y/277 V AC	480Y/277 V AC (up to 35 A)	125/250 V DC (1-/2-pole) <40 A
	480Y/277 V AC up to 35 A (K trip curve)	1P: 48 V DC and 2P: 96 VDC (2P in series)		240 V AC (up to 63 A)	60/125 V DC (1-/2-pole) >40 A
	240 V AC up to 63 A (all trip curves)			48/96 V DC (up to 63 A)	
	48/96 V DC up to 63 A (1-/2-pole, all trip curves)			48/96 V DC (up to 63 A)	
Short circuit interrupt rating	10 kA	14 kA	14 kA	10 kA	14 kA
Calibration temperature	40 °C	40 °C	40 °C	40 °C	25 °C
Mounting position	Any				
Protection degree	IP 20	IP 20	IP 20	IP 20	IP 20 with accessory
Mounting	35 mm DIN rail, front panel/dead front (with accessories)				
Terminal screw tightening torque	Please refer to data sheet				
Cable size	18–4 AWG				
Ambient temperature	-40 °C to +70 °C				
Shock resistance (IEC60068-2-27)	25 g - 2 shocks - 13 ms				
Service life, mechanical	20,000 operations				

NOTE: For the ambient temperature -40 °C up to +70 °C, average over a period of 24 hours shall not exceed +55 °C.

### Auxiliary contact S2C-H6RU and S2C-S6RU

<b>Rated current</b>	<b>10</b>
Rated voltage AC/DC	24
Contact	1 pole double throw
Connection capacity	18–14 AWG (0.75–2.5 mm <sup>2</sup> )
Tightening torque	11 in. lbs (1.2 Nm)
Shock resistance acc. to DIN IEC 68-2-6	5 g, 20 frequency cycles 5...150...5 Hz at 24 V AC/DC, 5 mA auto-reclosing < 10 ms
Mechanical service life	10,000 operations

### Shunt trip

		S2C-A1U	S2C-A2U
Rated voltage	V AC	12–60	110–415
	V DC	12–60	110–250
Maximum release duration	ms	<10	<10
Minimum release voltage	V AC	7	55
	V DC	10	80
Consumption on release	VA AC	40–200	55–210
	VA DC	40–200	55–110
Coil resistance	V	3.7	225
Terminals	AWG/mm <sup>2</sup>	18–6/0.75–16	18–6/0.75–16
Tightening torque	in. lbs./Nm	18/2	18/2

**ABB Products Proudly Distributed by Gross Automation.**  
**Please call +1 (262) 252-1600 or email [sales@grossautomation.com](mailto:sales@grossautomation.com).**

## Technical specifications

### Busbars PS...BP-C/CR and accessories

Electrical data	Busbars PS...BP-C/CR
Standards	UL508 EN 60947-1 / IEC 60947-1:2004
Rated voltage $U_e$	600 V AC/DC
Rated frequency	50 Hz (IEC) / 60 Hz (UL)
Rated impulse withstand voltage $U_{imp}$	$\geq 10$ kV
Rated current / phase	
End fed <sup>1)</sup>	100 A
Center fed <sup>1)</sup>	200 A
Short circuit current rating	10 kA
Mechanical data	
Housing	Gray, RAL 7035
Resistance to climatic conditions	Acc. to DIN EN 60068
Isolation coordination	
Overvoltage category	III
Pollution degree	2
Installation	
Cross section	25 mm <sup>2</sup>
Mounting position	Optional
Supply	Via cable with ring lug (PS...BP-CR); direct or via feeder terminal (PS...BP-C)
Accessories	
Shock protection caps	BSK BP-CR (for PS...BP-CR), BSK BP-C (for PS...BP-C)
Endcaps	PS-END 3 BP-C
Approvals	
	CE, RoHS
	UL 508: cULus listed

<sup>1)</sup> Independently from the current rating of the feeder terminal or busbar, the current-carrying capacity/current rating of the MCB terminal must not be exceeded.

#### Installation/assembly

Warning: When busbars are shortened, they must be deburred and cleaned of debris. Touch-safe only when used with the required end caps.

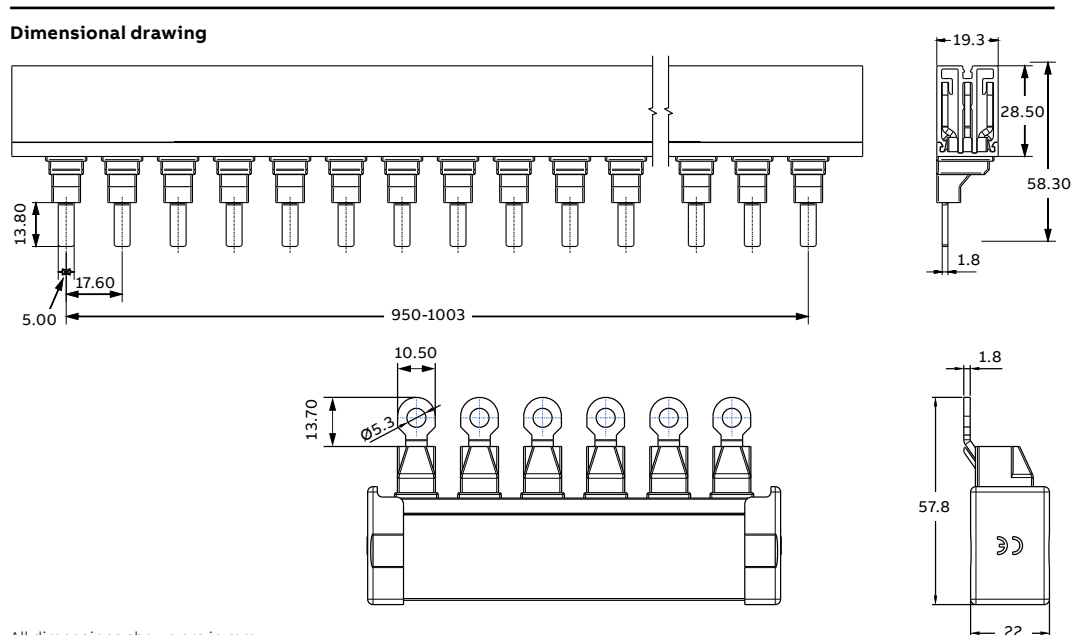

All dimensions shown are in mm.

## Technical specifications

SU200M, SU200ML, SUP200M, SU200MR and S200UDC — UL 489, CSA 22.2 No. 5

### Internal resistance and power loss per pole

Internal resistance per pole in mV, power loss per pole in W.

#### SU200M, SU200ML

Rated current $I_n$ A	C, K characteristics		Z characteristics	
	Internal resistance per pole $R_i$ mΩ	Power loss $P_v$ W	Internal resistance per pole $R_i$ mΩ	Power loss $P_v$ W
0.2	42500	1.7	-	-
0.3	18889	1.7	-	-
0.5	5600	1.4	9000	2.3
0.75	2489	1.4	-	-
1	1400	1.4	2200	2.2
1.6	703	1.8	1000	2.6
2	450	1.8	650	2.6
3	178	1.6	250	2.3
4	113	1.8	140	2.2
5	50	1.3	100	2.5
6	56	2.0	70	2.5
8	23	1.5	28	1.8
10	21	2.1	21	2.1
13	14	2.3	17	2.9
15	11	2.4	13	2.9
16	9.8	2.5	10	2.6
20	6.3	2.5	6.5	2.6
25	5.1	3.2	5.1	3.2
30	3.9	3.5	3.9	3.5
32	3.6	3.7	3.6	3.7
35	3.3	4.1	3.3	4.1
40	2.8	4.5	2.8	4.5
50	1.8	4.5	1.8	4.5
60	1.4	4.9	1.4	4.9
63	1.4	5.4	1.4	5.4

Internal resistances and power loss are subject to application-specific and environment-specific conditions and are therefore to be considered as typical values.

#### SU200MR

Rated current A	Internal resistance and power loss per pole	
	Internal resistance per pole $R_i$ mΩ	Power loss per pole $P_v$ W
0.2	25300	1.01
0.3	13700	1.23
0.5	4740	1.19
0.75	2067	1.16
1	1270	1.27
1.5	610	1.56
2	442	1.77
3	140	1.26
4	109	1.75
5	50	1.26
6	54	1.94
8	22	1.41
10	18.2	1.82
13	14.8	2.50
15	8.1	1.83
16	11.1	2.83
20	8.5	3.40
25	5.5	3.43
30	3.8	3.39
32	4.6	4.70
35	3.9	4.76
40	2.8	4.40
50	1.7	4.25
60	1.7	6.18
63	1.9	7.56

Internal resistances and power loss are subject to application-specific and environment-specific conditions and are therefore to be considered as typical values.

#### SUP200M

Rated current $I_n$ A	C, K characteristics		Z characteristics	
	Internal resistance per pole $R_i$ mΩ	Power loss $P_v$ W	Internal resistance per pole $R_i$ mΩ	Power loss $P_v$ W
1	1400	1.4	2200	2.2
1.6	703	1.8	1000	2.6
2	450	1.8	650	2.6
3	178	1.6	250	2.3
4	113	1.8	140	2.2
5	50	1.3	100	2.5
6	56	2.0	70	2.5
7	27	1.3	35	1.7
8	23	1.5	28	1.8
10	21	2.1	21	2.1
13	14	2.3	17	2.9
15	11	2.4	13	2.9
16	9.8	2.5	10	2.6
20	6.3	2.5	6.5	2.6
25	5.1	3.2	5.1	3.2
30	3.9	3.5	3.9	3.5
32	3.6	3.7	3.6	3.7
35	3.3	4.1	3.3	4.1
40	2.8	4.5	2.8	4.5

Internal resistances and power loss are subject to application-specific and environment-specific conditions and are therefore to be considered as typical values.

## Technical specifications

SU200M, SU200ML, SUP200M, SU200MR and S200UDC — UL 489, CSA 22.2 No. 5

### Temperature derating for SU200M, SU200ML, SUP200M and SU200MR

Standard	Rated current $I_n$ A	Maximum operating current at ambient temperature T A											
		- 40 °C	- 30 °C	- 20 °C	- 10 °C	0 °C	10 °C	20 °C	30 °C	40 °C	50 °C	60 °C	70 °C
UL 489	0.2 <sup>1)</sup>	0.27	0.26	0.25	0.24	0.23	0.22	0.22	0.21	0.20	0.19	0.19	0.18
	0.3 <sup>1)</sup>	0.40	0.39	0.37	0.36	0.35	0.33	0.32	0.31	0.30	0.29	0.28	0.27
	0.5	0.67	0.64	0.62	0.60	0.58	0.56	0.54	0.52	0.5	0.48	0.46	0.45
	0.75 <sup>1)</sup>	1.00	0.97	0.93	0.90	0.87	0.84	0.81	0.78	0.75	0.72	0.70	0.67
	1	1.34	1.29	1.24	1.20	1.16	1.12	1.08	1.04	1	0.96	0.93	0.89
	1.6	1.74	1.68	1.62	1.56	1.50	1.45	1.40	1.35	1.3	1.25	1.21	1.16
	2	2.67	2.58	2.49	2.40	2.31	2.23	2.15	2.07	2	1.93	1.85	1.79
	3	4.01	3.87	3.73	3.60	3.47	3.35	3.23	3.11	3	2.89	2.78	2.68
	4	5.35	5.16	4.97	4.80	4.63	4.46	4.30	4.15	4	3.85	3.71	3.57
	5	6.69	6.45	6.22	6.00	5.78	5.58	5.38	5.19	5	4.82	4.64	4.47
	6	8.02	7.74	7.46	7.20	6.94	6.69	6.45	6.22	6	5.78	5.56	5.36
	8	10.70	10.32	9.95	9.59	9.25	8.92	8.60	8.30	8	7.70	7.42	7.14
	10	13.37	12.90	12.44	11.99	11.56	11.15	10.75	10.37	10	9.63	9.27	8.93
	13	17.38	16.76	16.17	15.59	15.03	14.50	13.98	13.48	13	12.52	12.06	11.61
	15	20.06	19.34	18.65	17.99	17.35	16.73	16.13	15.56	15	14.45	13.91	13.40
	16	21.40	20.63	19.90	19.19	18.50	17.84	17.21	16.59	16	15.41	14.84	14.29
	20	26.75	25.79	24.87	23.98	23.13	22.30	21.51	20.74	20	19.26	18.55	17.86
	25	33.43	32.24	31.09	29.98	28.91	27.88	26.88	25.93	25	24.08	23.18	22.33
	30	40.12	38.69	37.31	35.98	34.69	33.45	32.26	31.11	30	28.89	27.82	26.79
	32	42.79	41.27	39.79	38.37	37.01	35.69	34.41	33.18	32	30.82	29.68	28.58
35	46.81	45.14	43.53	41.97	40.47	39.03	37.64	36.30	35	33.71	32.46	31.26	
40	53.49	51.58	49.74	47.97	46.26	44.61	43.01	41.48	40	38.52	37.09	35.72	
50	66.87	64.48	62.18	59.96	57.82	55.76	53.77	51.85	50	48.15	46.37	44.65	
60	80.24	77.38	74.61	71.95	69.39	66.91	64.52	62.22	60	57.78	55.64	53.58	
63	84.25	81.24	78.35	75.55	72.85	70.25	67.75	65.33	63	60.67	58.42	56.26	

<sup>1)</sup> Current ratings 0.2, 0.3 and 0.75 A available with K characteristic only.

---

## Technical specifications

### S200UDC series DC applications

**DC = Direct current**

S200UDC MCBs can be used in the one-pole version at 125 V DC (60 V DC above 40 A), and in the 2-pole version, with both poles connected in series, at 250 V DC (125 V DC above 40 A).

S200UDC contains fitted permanent magnets, which assist in the forced extinguishing of the arc. If voltages to earth exceeding 125 V DC (60 V DC above 40 A) may occur, 2-pole S200UDC is to be used for one-pole disconnection.

For DC incoming supply from above S200UDC-... MCBs have, in the area of arc chutes, permanent magnets. It is therefore necessary to take into account the polarity during the installation process.

Doing so ensures that in the case of a short circuit, the magnetic field of the permanent magnets corresponds with the electromagnetic field of the short-circuit current, therefore safely leading the short circuit into the arc chute.

Incorrect polarities may cause damage to the MCB. This is why, in the case of top-fed devices, terminal 1 must be connected to (-) and terminal 3 to (+).

## Technical specifications

### S200UDC series DC applications

Example for permissible voltages between the conductors depending on the number of poles and circuit layout (for ampacities up to 40 A; for ampacities above 40 A, the corresponding voltages are reduced to 60 V and 125 V instead of 125 V and 250 V, respectively):

<b>Voltage between conductors</b>	Un	125 V	250 V	250 V	250 V
<b>Voltage between conductor and earth</b>	Un	125 V	125 V	250 V	125 V
<b>MCB</b>		1-pole	2-pole	2-pole	2-pole
		S201UDC	S202UDC	S202UDC	S202UDC

Supply from below

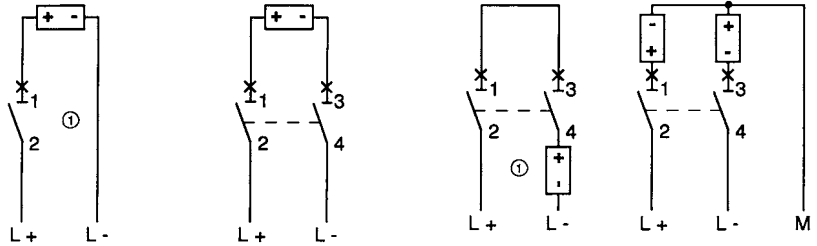

Supply from above

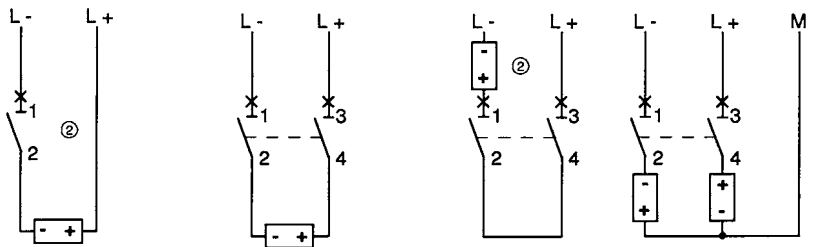

Examples for different voltage levels between conductor and earth in the case of identical voltage between conductors:

<b>Voltage between conductors</b>	Un	250 V (125 V above 40 A) All-pole disconnection	250 V (125 V above 40 A) 1-pole disconnection
<b>Voltage between conductor and earth</b>	Un	125 V (60 V above 40 A) Circuit symmetrically earthed	250 V (125 V above 40 A) Circuit unsymmetrically earthed
<b>MCB</b>		2-pole	2-pole
		S202UDC	S202UDC

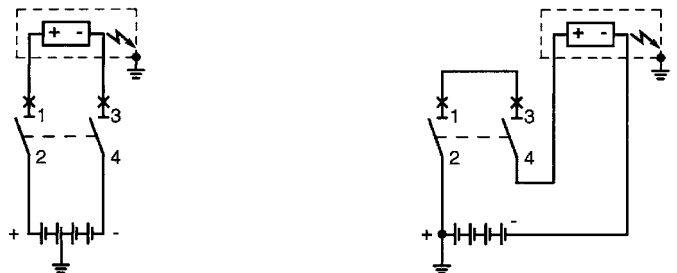

1 In the circuit diagram, the negative pole is earthed.  
2 In the circuit diagram, the positive pole is earthed.

## Approximate dimensions

SU200M, SUP200M, SU200MR, SU200ML and S200UDC — UL 489, CSA 22.2 No. 5

### SU200M, SUP200M

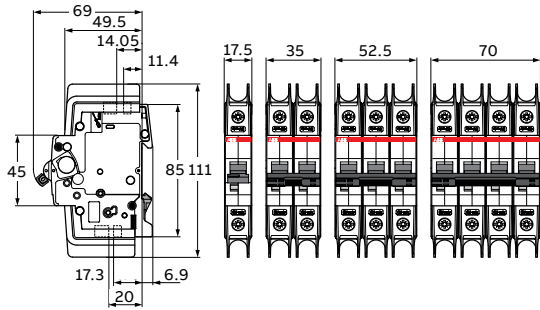

### S200UDC

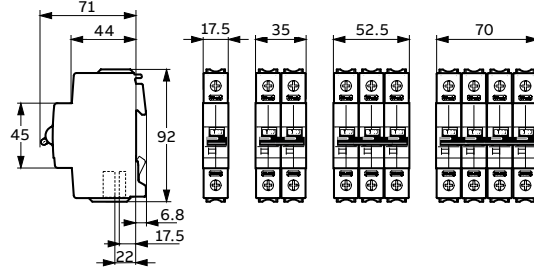

### SU200MR

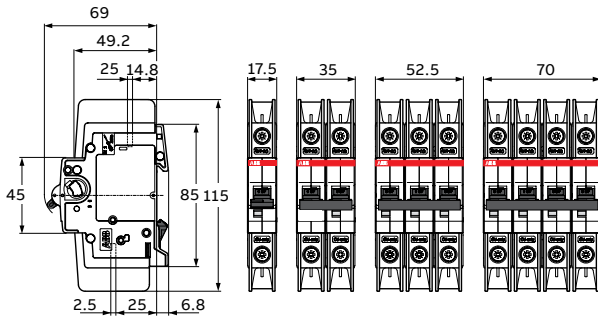

### SU200ML

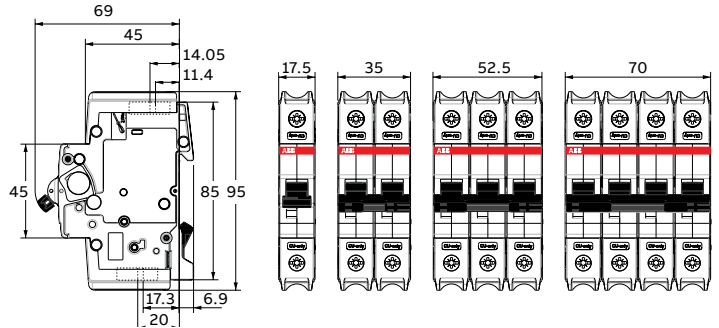

### S2C-H6RU, S2C-S6RU

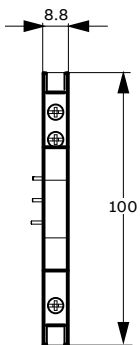

### S2C-A..U

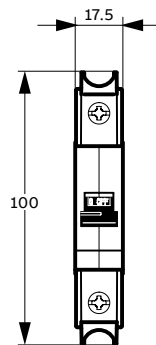

All dimensions shown are in mm.

## Technical specifications

### S800U

					<b>S800U</b>
<b>Characteristics</b>					<b>K, Z</b>
Rated operational current $I_e$				[A]	10...100
Pole					1...4
Rated operational voltage $U_e$ compliant to UL489					
(AC)		50/60 Hz		[V]	240
Rated ultimate short-circuit breaking capacity compliant to UL489					
(AC)	50/60 Hz	240 V	Single-pole	[kA]	30
(AC)	50/60 Hz	240 V	Multi-pole	[kA]	50
Connections $C_u$				10–30 A	14–2 AWG
				40–100 A	8–1 AWG
Rated frequency				[Hz]	50/60
Tightening torque				[Nm]	3,5 (31 in. lb.)
Protection category					IP40 (actuating end only)
Mounting position					Any
Contacts					Cadmium-free
Permissible ambient temperature				[°C]	-25 °C to 60 °C
Standards					UL489 CSA22.2 No.5-02
Approval					cULus File E312425

## Technical specifications

### S800U

Typical internal resistances and power losses at 25 °C ambient temperature

Rated current $I_n$ [A]	Internal resistance $R_i$ [mΩ] K, Z	Power loss $P_v$ [W] K, Z
10	15.2	1.5
15	12.1	2.7
20	8.7	3.5
25	6.8	4.2
30	3.1	2.8
40	2.3	3.7
50	1.7	4.3
60	1.6	5.8
70	1.0	6.4
80	1.0	6.4
90	0.8	6.5
100	0.8	8.3

### Influence of ambient temperature

Devices mounted singly (specifications in A).

S800U-K, -Z

$I_n$ [A]	10 °C	15 °C	20 °C	25 °C	30 °C	35 °C	40 °C	45 °C	50 °C	55 °C	60 °C
10	10.9	10.7	10.4	10.0	9.6	9.3	9.0	8.7	8.4	8.0	7.6
15	16.5	16.0	15.6	15.0	14.4	14.0	13.5	13.0	12.6	12.0	11.4
20	22.0	21.4	20.8	20.0	19.2	18.6	18.0	17.4	16.8	16.0	15.2
25	27.5	26.8	26.0	25.0	24.0	23.3	22.5	21.8	21.0	20.0	19.0
30	33.1	32.1	31.2	30.0	28.8	27.9	27.0	26.1	25.2	24.0	22.9
40	44.0	42.8	41.6	40.0	38.4	37.2	36.0	34.8	33.6	32.0	30.9
50	55.1	53.5	52.0	50.0	48.0	46.5	45.0	43.5	42.0	40.0	38.3
60	66.2	64.2	62.4	60.0	57.6	55.8	54.0	52.2	50.4	48.0	46.0
70	76.9	74.9	72.8	70.0	67.2	65.1	63.0	60.9	58.8	56.0	53.4
80	88.0	85.6	83.2	80.0	76.8	74.4	72.0	69.6	67.1	64.0	61.6
90	99.1	96.3	93.6	90.0	86.4	83.7	81.0	78.3	75.6	72.0	69.5
100	110.5	107.0	104.0	100.0	96.0	93.0	90.0	87.0	83.8	80.0	77.8

ABB Products Proudly Distributed by Gross Automation.

Please call +1 (262) 252-1600 or email [sales@grossautomation.com](mailto:sales@grossautomation.com).

## Technical specifications

### S800U

#### Auxiliary contact S800-AUX

	<b>S800-AUX</b>
Usage category	AC15 400/2 A-UL AC15 240/ -UL DC13 250/0.55 A125 V/1.1A-IEC DC13 125 V/1.1A DC13 60 V/2A DC13 24 V/4A
Continuous thermal current $I_n$	6 A
Rated insulation voltage $U_i$	690 V
Number of contacts	2
Surge $U_{test}$ (1.2/50 $\mu$ s)	6 kV
Degree of protection	3
Function of contact	Changeover contacts
Connection Cu	1 x 2.5 mm <sup>2</sup> 2 x 1.5 mm <sup>2</sup>
Tightening torque	1 Nm
Ensured contacts during shake test	5g, 20 frequency cycle
acc. to IEC 68-2-6	at 24 V AC/DC, 5mA brief interrupt <10 ms
AC/DC supply	Any EN 60715
Mounting on DIN top hat rail	EN 60715 IP20
Type of protection	IP20
Permissible ambient temperature for operations	-25 °C to 60 °C; -13 °F to 140 °F
Storage temperature	-40°C to 70 °C; -40 °F to 158 °F
Mechanical device service life	6000 switching cycles
$I_{cu}$ with S450E	1000 A
Resistance to vibration	IEC 60068-2-27; IEC 60068-2; EN 61373 Cat. 1/class B

#### Undervoltage release S800-UVR

	<b>S800-UVR36</b>	<b>S800-UVR60</b>	<b>S800-UVR130</b>	<b>S800-UVR250</b>
Rated voltage $U_e$	24–36 V AC/DC	48–60 V AC/DC	110–30 V AC/DC	220–250 V AC/DC
Operating range				
Operating opening	35...70% $U_e$			
Operating closing	85% $U_e$			
Rated insulation voltage $U_i$	690 V			
Coil pull in consumption	1 W, 14 VA	1 W, 25 VA	1 W, 41 VA	1 W, 91 VA
Rated frequency	DC; 50/60 Hz			
Protection degree	3			
Connection Cu	1...35 cable			
Tightening torque	min. 3/max. 4 Nm			
AC/DC supply	Any			
DIN top hat rail	EN 60715			
Type of protection	IP20 IP40 (only actuation side)			
Permissible ambient temperature of operations	-25 °C to 60 °C; -13 °F to 140 °F			
Storage temperature	-40°C to 70 °C; -40 °F to 158 °F			
S800-UVR36	IEC 60068-2-27; IEC 60068-2; EN61373 Cat. 1/class B			

## Technical specifications

### S800U

#### Combined auxiliary and bell alarm

Usage category	AC15 400/2 A-UL AC15 240/6A-UL DC13 250/0.55 A125 V/1.1A-IEC DC13 125 V/1.1A-IEC DC13 60 V/2A DC13 24 V/4A
Continuous thermal current $I_n$	6 A
Rated insulation voltage $U_i$	690 V
Number of contacts	2 (1x AUX, 1 x AUX/ALT)
Surge $U_{test}$ (1.2/50 $\mu$ s)	6 kV
Degree of protection	3
Function of contact	Changeover contacts
Connection Cu	1 x 2.5 mm <sup>2</sup> 2 x 1.5 mm <sup>2</sup>
Tightening torque	1 Nm
Ensured contacts during shake test	5g, 20 frequency cycle
acc. to IEC 68-2-6	5...150...5 Hz at 24 V AC/DC, 5 mA brief interrupt <10 ms
AC/DC supply	Any EN 60715
Mounting on DIN top hat rail	EN 60715
Type of protection	IP20
Permissible ambient temperature for operations	-25 °C to 60 °C; -13 °F to 140 °F
Storage temperature	-40°C to 70 °C; -40 °F to 158 °F
Mechanical device service life	6000 switching cycles
$I_{cu}$ with S450E	1000 A
Resistance to vibration	IEC 60068-2-27; IEC 60068-2; EN 61373 Cat. 1/class B

#### Shunt operation release — S800-SOR

	S800-SOR24	S800-SOR130	S800-SOR250	S800-SOR400
Rated voltage $U_e$	24 V AC/DC	48–130 V AC/DC	110–250 V AC/DC	220–250 V AC/DC
Operating range				70–110% $U_e$
Rated insulation voltage $U_i$				690 V
Coil pull in consumption	19.2 W/VA			On request
Rated frequency				DC; 50/60 Hz
Protection degree				3
Connection Cu				1–35 AWG
Tightening torque				min. 3/max. 4 Nm
AC/DC supply				Any
DIN top hat rail				EN 60715
Type of protection				IP20 IP40 (only actuation side)
Permissible ambient temperature of operations				-25 °C to 60 °C; -13 °F to 140 °F
Storage temperature				-40°C to 70 °C; -40 °F to 158 °F
S800-UVR36				IEC 60068-2-27; IEC 60068-2; EN61373 Cat. 1/class B

**Approximate dimensions**

**S800U**

**S800U**

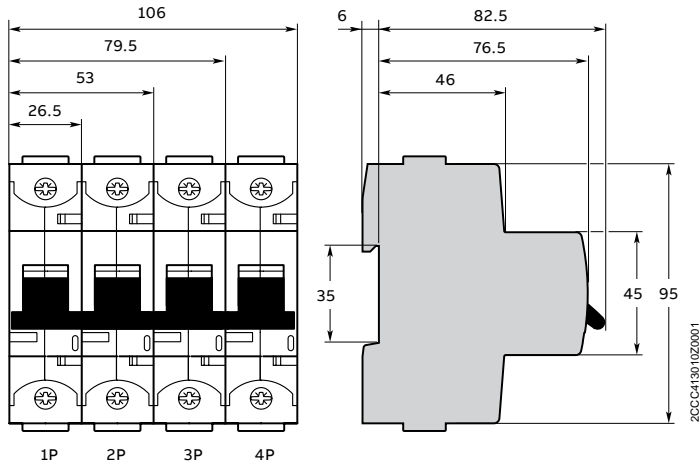

**S800-SOR and S800-UVR**

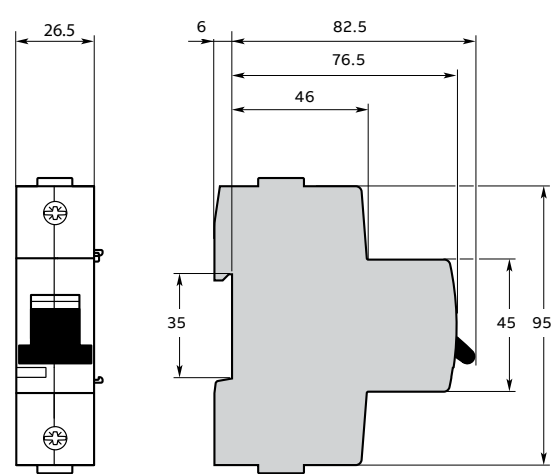

**S800-AUX**

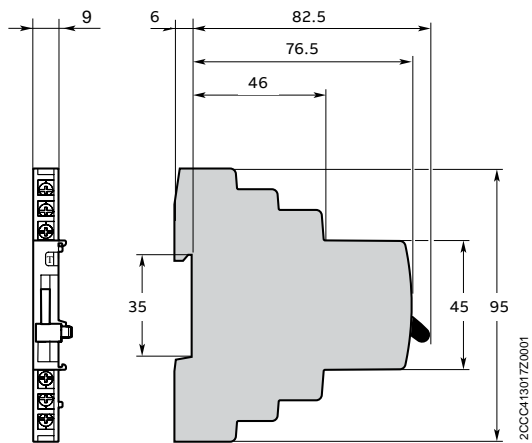

**S800-AUX/ALT**

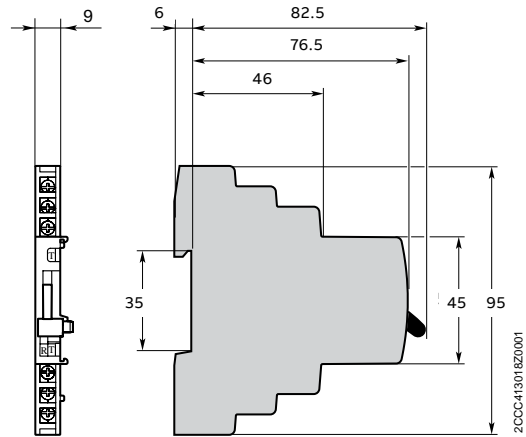

**S800-RD AND S800-RHE**

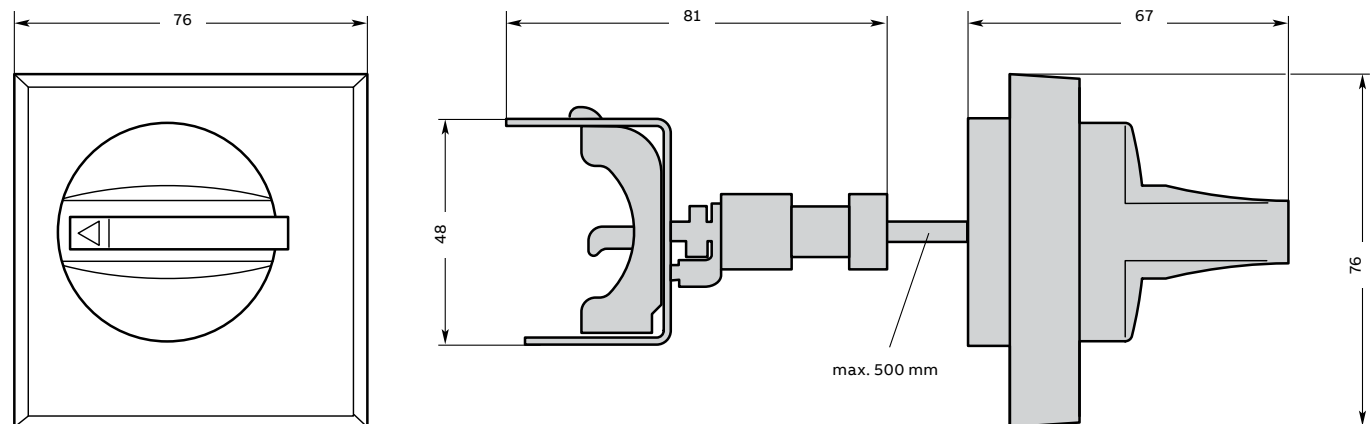

All dimensions shown are in mm.

## S804U-UCZ

This breaker is specially designed for networks up to 600 V DC, i.e., a data center. It is available as 4-pole version with a short-circuit current rating of 10 kA according to UL 489.

### Technical specifications

Standard	UL 489
Characteristic	Z
Rated current $I_n$	10–80 A
Rated voltage $U_n$	600 V DC
No. of poles	4
Short-circuit current rating acc. to UL 489	10 kA
Tightening torque	3.5 Nm (31 in. lb.)
Protection category	IP40 (actuating end only)
Mounting position	Any
Contacts	Cadmium-free
Reference temperature for tripping characteristic	25 °C
Ambient temperature	-25 °C to 60 °C
Storage temperature	-40 °C to 70 °C
Approval	cULus File #E312425

# S804U-UCZ

## Tested and listed wirings

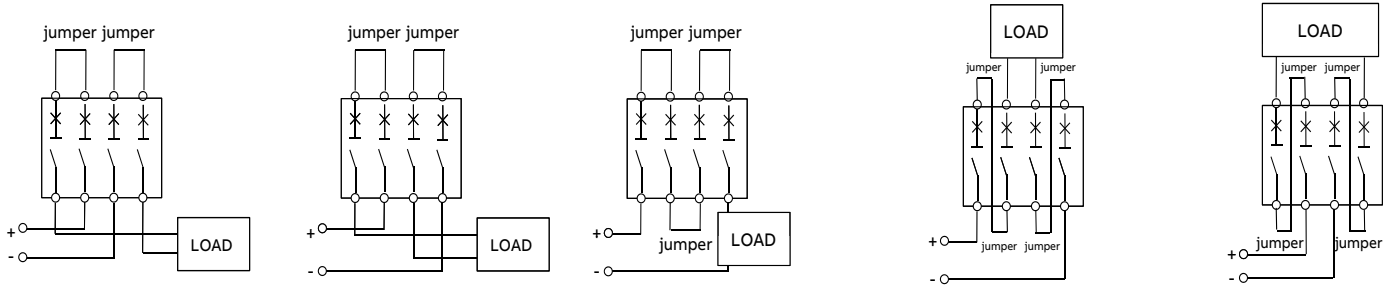

Line and load might be reversed

Ampere rating	10–32 A	40–63 A	70–80 A
Conductor type	Single conductor per terminal – copper only, 60/75 °C wire	Single conductor per terminal – copper only, 60 °C wire only	Single conductor per terminal – copper only, 60 °C wire only
AWG, wire range	14 AWG–2 AWG Cu, solid or stranded	1/0 AWG–8 AWG Cu, solid or stranded	1/0 AWG–8 AWG Cu, solid or stranded
Jumper length	1 ft. 30.5 cm	1 ft. 30.5 cm	2 ft. 61 cm

## Trip curves for S804U-UCZ

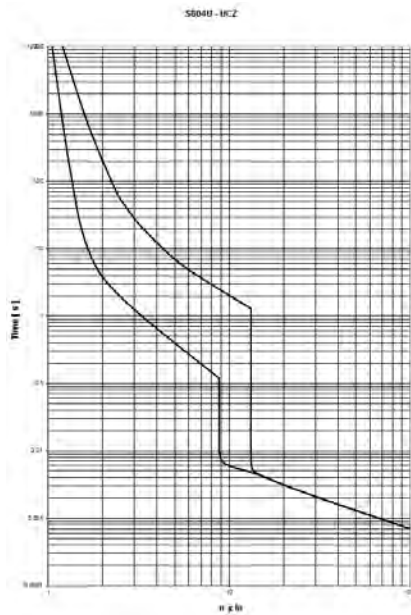

### Tripping behavior acc. to UL489

Thermal tripping: 1.00...1.35 x Ie

Electromagnetic tripping 11 x Ie ± 20 %

## Dimension of S804U-UCZ

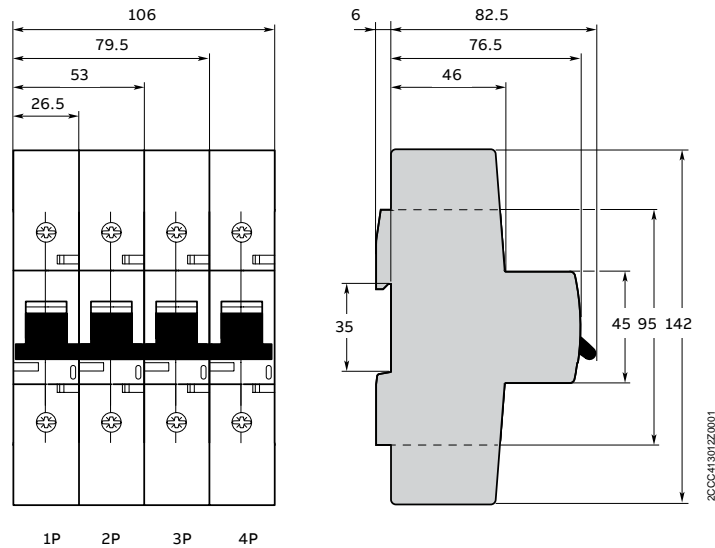

All dimensions shown are in mm.

20CC41301Z0001

# UL 1077 series

## ST200M, S200MUC, S200MR, S800S, S800C, S800P, S300P, ST200MTR series



### Description

The UL 1077 family of supplementary protectors offers a compact solution for protection requirements. The devices are DIN rail mounted.

The UL 1077 MCBs are available with application-specific trip characteristics to provide maximum circuit protection.

The supplementary protectors offer thermal magnetic trip protection according to B, C, D, K and Z trip curves.

For the worldwide market, the breakers carry UL, CSA, IEC, CE and many other agency approvals and certifications.

### Features

- Energy limiting
- Fast breaking time (2.3–2.5 ms)
- Bus connection system
- Wide range of accessories
- Available with variable depth handle mechanism
- CE certified and marked
- DIN rail mounting
- Finger-safe terminals
- Multi-function terminals
- Suitable for reverse feed
- UL 1077 recognized supplemental protective device, UL file #E76126 and E167556



### S800S, S800C and S800P series

The small pole width of only 27 mm allows a space-saving installation. The current range covers nominal rated currents from 10 A up to 63 A (S800C) and 6 A up to 63 A (S800C) and 80 A and 100 A (S800P) with a maximum rated short-circuit interrupt rating of up to 20 kA (S800C/P) and 30 kA (S800S) in UL applications.

Due to the number of global standards met by the S800C/S/P, the flexibility for worldwide installation is high. A single product can fulfill the needs of both, IEC and UL applications.

### Features

- Rated operational voltage up to 480Y/277 V AC – 500 V DC (S800C/P) and 600Y/347 V AC (S800S), respectively (UL)
- Compression terminals can be easily converted to ring tongue terminals
- Compact
- Space saving

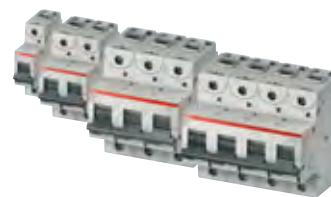



	ST200M	S200MUC	S200MR	S800S	S800C	S800P	S300P	ST200MTR
Ampacity	0.5 to 63 A	0.2 to 63 A	0.2 to 63 A	0.5 to 63 A	10 to 63 A	80 A and 100 A	0.2 to 63 A	0.5 to 63 A
Voltage	480Y/277 V AC	480Y/277 V AC	480Y/277 V AC	600Y/347 V AC	480Y/277 V AC	480Y/277 V AC	480Y/277 V AC	480Y/277 V AC
	60/125 V DC (1-/2-pole)	250/500 V DC (1-/2-pole)	48/96 V DC (1-/2-pole)	–	up to 500 V DC	up to 500 V DC	60/125 V DC (1-/2-pole)	1-pole: 250 V DC; 2-/4-pole: up to 500 V DC
Poles	1, 2, 3, 4	1, 2, 3, 4	1, 2, 3, 4	1, 2, 3, 4	1, 2, 3, 4	1, 2, 3, 4	1, 2, 3, 4	1, 2, 3, 4 AC 1, 2, 4 DC
Trip curves	B, C, D, K, Z	C, K, Z	K	B, C, D, K	B, C, D, K	B, C, D, K	B, C, D, K, Z	K, Z
Short circuit interrupt rating	10/5 kA	up to 10 kA	10 kA	up to 30 kA	up to 20 kA	up to 20 kA	10 kA	ST200MTR: 6 kA ST200MTR (DC): 10 kA
Auxiliary contacts	yes	yes	yes	yes	yes	yes	yes	yes
Bell alarm	yes	yes	yes	yes	yes	yes	yes	yes
Shunt trip	yes	yes	yes	yes	yes	yes	yes	yes
Bottom-mount aux. contact	yes	yes	–	–	–	–	yes	–
Busbars	yes	yes	yes	–	–	–	yes	Ring tongue busbar

**ABB Products Proudly Distributed by Gross Automation.**

**Please call +1 (262) 252-1600 or email [sales@grossautomation.com](mailto:sales@grossautomation.com).**

# ST200M-B

Supplemental protectors — UL 1077, CSA 22.2 No. 235

	Rated current			Rated current					
	Number of poles	$I_n$ A	Cat. no.	Number of poles	$I_n$ A	Cat. no.			
	1	0.5	ST201M-B0.5	2	0.5	ST202M-B0.5			
		1	ST201M-B1		1	ST202M-B1			
		1.6	ST201M-B1.6		1.6	ST202M-B1.6			
		2	ST201M-B2		2	ST202M-B2			
		3	ST201M-B3		3	ST202M-B3			
		4	ST201M-B4		4	ST202M-B4			
		5	ST201M-B5		5	ST202M-B5			
		6	ST201M-B6		6	ST202M-B6			
		7	ST201M-B7		7	ST202M-B7			
		8	ST201M-B8		8	ST202M-B8			
		10	ST201M-B10		10	ST202M-B10			
		13	ST201M-B13		13	ST202M-B13			
		15	ST201M-B15		15	ST202M-B15			
		16	ST201M-B16		16	ST202M-B16			
		20	ST201M-B20		20	ST202M-B20			
		25	ST201M-B25		25	ST202M-B25			
		30	ST201M-B30		30	ST202M-B30			
			1+NA		0.5	ST201M-B0.5NA	3	0.5	ST203M-B0.5
					1	ST201M-B1NA		1	ST203M-B1
1.6	ST201M-B1.6NA			1.6	ST203M-B1.6				
2	ST201M-B2NA			2	ST203M-B2				
3	ST201M-B3NA			3	ST203M-B3				
4	ST201M-B4NA			4	ST203M-B4				
5	ST201M-B5NA			5	ST203M-B5				
6	ST201M-B6NA			6	ST203M-B6				
7	ST201M-B7NA			7	ST203M-B7				
8	ST201M-B8NA			8	ST203M-B8				
10	ST201M-B10NA			10	ST203M-B10				
13	ST201M-B13NA			13	ST203M-B13				
15	ST201M-B15NA			15	ST203M-B15				
16	ST201M-B16NA			16	ST203M-B16				
20	ST201M-B20NA			20	ST203M-B20				
25	ST201M-B25NA			25	ST203M-B25				
30	ST201M-B30NA			30	ST203M-B30				
32	ST201M-B32NA			32	ST203M-B32				
35	ST201M-B35NA			35	ST203M-B35				
40	ST201M-B40NA	40	ST203M-B40						
50	ST201M-B50NA	50	ST203M-B50						
60	ST201M-B60NA	60	ST203M-B60						
63	ST201M-B63NA	63	ST203M-B63						

Diagram

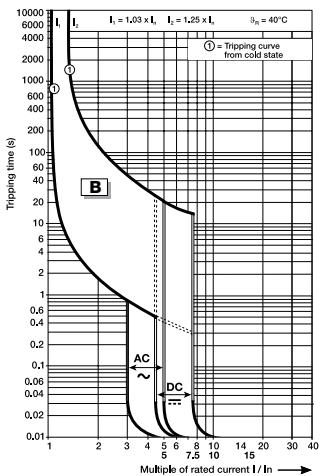



## ST200M-B (cont.)

Supplemental protectors — UL 1077, CSA 22.2 No. 235

Number of poles	Rated current		Number of poles	Rated current	
	$I_n$ A	Cat. no.		$I_n$ A	Cat. no.
3+NA	0.5	ST203M-B0.5NA	4	0.5	ST204M-B0.5
	1	ST203M-B1NA		1	ST204M-B1
	1.6	ST203M-B1.6NA		1.6	ST204M-B1.6
	2	ST203M-B2NA		2	ST204M-B2
	3	ST203M-B3NA		3	ST204M-B3
	4	ST203M-B4NA		4	ST204M-B4
	5	ST203M-B5NA		5	ST204M-B5
	6	ST203M-B6NA		6	ST204M-B6
	7	ST203M-B7NA		7	ST204M-B7
	8	ST203M-B8NA		8	ST204M-B8
	10	ST203M-B10NA		10	ST204M-B10
	13	ST203M-B13NA		13	ST204M-B13
	15	ST203M-B15NA		15	ST204M-B15
	16	ST203M-B16NA		16	ST204M-B16
	20	ST203M-B20NA		20	ST204M-B20
	25	ST203M-B25NA		25	ST204M-B25
	30	ST203M-B30NA		30	ST204M-B30
	32	ST203M-B32NA		32	ST204M-B32
	35	ST203M-B35NA		35	ST204M-B35
	40	ST203M-B40NA		40	ST204M-B40
	50	ST203M-B50NA		50	ST204M-B50
	60	ST203M-B60NA		60	ST204M-B60
	63	ST203M-B63NA		63	ST204M-B63

# ST200M-C

Supplemental protectors — UL 1077, CSA 22.2 No. 235

	Number of poles	Rated current		Cat. no.	Number of poles	Rated current	
		$I_n$ A				$I_n$ A	Cat. no.
	1	0.5		ST201M-C0.5	2	0.5	ST202M-C0.5
		1		ST201M-C1		1	ST202M-C1
		1.6		ST201M-C1.6		1.6	ST202M-C1.6
		2		ST201M-C2		2	ST202M-C2
		3		ST201M-C3		3	ST202M-C3
		4		ST201M-C4		4	ST202M-C4
		5		ST201M-C5		5	ST202M-C5
		6		ST201M-C6		6	ST202M-C6
		7		ST201M-C7		7	ST202M-C7
		8		ST201M-C8		8	ST202M-C8
		10		ST201M-C10		10	ST202M-C10
		13		ST201M-C13		13	ST202M-C13
		15		ST201M-C15		15	ST202M-C15
		16		ST201M-C16		16	ST202M-C16
		20		ST201M-C20		20	ST202M-C20
		25		ST201M-C25		25	ST202M-C25
		30		ST201M-C30		30	ST202M-C30
		32		ST201M-C32		32	ST202M-C32
		35		ST201M-C35		35	ST202M-C35
		40		ST201M-C40		40	ST202M-C40
50		ST201M-C50	50	ST202M-C50			
60		ST201M-C60	60	ST202M-C60			
63		ST201M-C63	63	ST202M-C63			
	1+NA	0.5		ST201M-C0.5NA	3	0.5	ST203M-C0.5
		1		ST201M-C1NA		1	ST203M-C1
		1.6		ST201M-C1.6NA		1.6	ST203M-C1.6
		2		ST201M-C2NA		2	ST203M-C2
		3		ST201M-C3NA		3	ST203M-C3
		4		ST201M-C4NA		4	ST203M-C4
		5		ST201M-C5NA		5	ST203M-C5
		6		ST201M-C6NA		6	ST203M-C6
		7		ST201M-C7NA		7	ST203M-C7
		8		ST201M-C8NA		8	ST203M-C8
		10		ST201M-C10NA		10	ST203M-C10
		13		ST201M-C13NA		13	ST203M-C13
		15		ST201M-C15NA		15	ST203M-C15
		16		ST201M-C16NA		16	ST203M-C16
20		ST201M-C20NA	20	ST203M-BC20			
25		ST201M-C25NA	25	ST203M-C25			
30		ST201M-C30NA	30	ST203M-C30			
32		ST201M-C32NA	32	ST203M-C32			
35		ST201M-C35NA	35	ST203M-C35			
40		ST201M-C40NA	40	ST203M-C40			
50		ST201M-C50NA	50	ST203M-C50			
60		ST201M-C60NA	60	ST203M-C60			
63		ST201M-C63NA	63	ST203M-C63			

Diagram

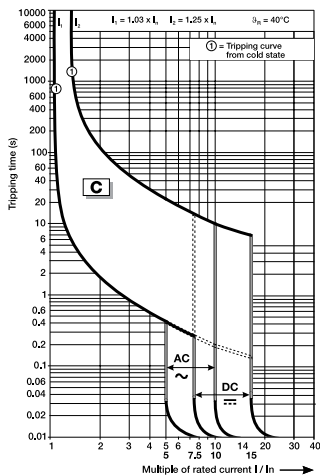



## ST200M-C (cont.)

Supplemental protectors — UL 1077, CSA 22.2 No. 235

Number of poles	Rated current		Number of poles	Rated current	
	$I_n$ A	Cat. no.		$I_n$ A	Cat. no.
3+NA	0.5	ST203M-C0.5NA	4	0.5	ST204M-C0.5
	1	ST203M-C1NA		1	ST204M-C1
	1.6	ST203M-C1.6NA		1.6	ST204M-C1.6
	2	ST203M-C2NA		2	ST204M-C2
	3	ST203M-C3NA		3	ST204M-C3
	4	ST203M-C4NA		4	ST204M-C4
	5	ST203M-C5NA		5	ST204M-C5
	6	ST203M-C6NA		6	ST204M-C6
	7	ST203M-C7NA		7	ST204M-C7
	8	ST203M-C8NA		8	ST204M-C8
	10	ST203M-C10NA		10	ST204M-C10
	13	ST203M-C13NA		13	ST204M-C13
	15	ST203M-C15NA		15	ST204M-C15
	16	ST203M-C16NA		16	ST204M-C16
	20	ST203M-C20NA		20	ST204M-C20
	25	ST203M-C25NA		25	ST204M-C25
	30	ST203M-C30NA		30	ST204M-C30
	32	ST203M-C32NA		32	ST204M-C32
	35	ST203M-C35NA		35	ST204M-C35
	40	ST203M-C40NA		40	ST204M-C40
	50	ST203M-C50NA		50	ST204M-C50
	60	ST203M-C60NA		60	ST204M-C60
	63	ST203M-C63NA		63	ST204M-C63

# ST200M-D

Supplemental protectors — UL 1077, CSA 22.2 No. 235

	Number of poles	Rated current		Cat. no.	Number of poles	Rated current				
		$I_n$ A				$I_n$ A	Cat. no.			
	1	0.5		ST201M-D0.5	2	0.5	ST202M-D0.5			
		1		ST201M-D1		1	ST202M-D1			
		1.6		ST201M-D1.6		1.6	ST202M-D1.6			
		2		ST201M-D2		2	ST202M-D2			
		3		ST201M-D3		3	ST202M-D3			
		4		ST201M-D4		4	ST202M-D4			
		5		ST201M-D5		5	ST202M-D5			
		6		ST201M-D6		6	ST202M-D6			
		7		ST201M-D7		7	ST202M-D7			
		8		ST201M-D8		8	ST202M-D8			
		10		ST201M-D10		10	ST202M-D10			
		13		ST201M-D13		13	ST202M-D13			
		15		ST201M-D15		15	ST202M-D15			
		16		ST201M-D16		16	ST202M-D16			
		20		ST201M-D20		20	ST202M-D20			
		25		ST201M-D25		25	ST202M-D25			
		30		ST201M-D30		30	ST202M-D30			
			1+NA	0.5			ST201M-D0.5NA	3	0.5	ST203M-D0.5
				1			ST201M-D1NA		1	ST203M-D1
1.6				ST201M-D1.6NA	1.6	ST203M-D1.6				
2				ST201M-D2NA	2	ST203M-D2				
3				ST201M-D3NA	3	ST203M-D3				
4				ST201M-D4NA	4	ST203M-D4				
5				ST201M-D5NA	5	ST203M-D5				
6				ST201M-D6NA	6	ST203M-D6				
7				ST201M-D7NA	7	ST203M-D7				
8				ST201M-D8NA	8	ST203M-D8				
10				ST201M-D10NA	10	ST203M-D10				
13				ST201M-D13NA	13	ST203M-D13				
15				ST201M-D15NA	15	ST203M-D15				
16				ST201M-D16NA	16	ST203M-D16				
20				ST201M-D20NA	20	ST203M-D20				
25				ST201M-D25NA	25	ST203M-D25				
30				ST201M-D30NA	30	ST203M-D30				
32				ST201M-D32NA	32	ST203M-D32				
35				ST201M-D35NA	35	ST203M-D35				
40		ST201M-D40NA	40	ST203M-D40						
50		ST201M-D50NA	50	ST203M-D50						
60		ST201M-D60NA	60	ST203M-D60						
63		ST201M-D63NA	63	ST203M-D63						

Diagram

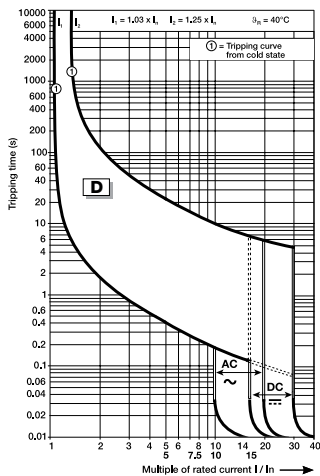



## ST200M-D (cont.)

Supplemental protectors — UL 1077, CSA 22.2 No. 235

Number of poles	Rated current		Number of poles	Rated current	
	$I_n$ A	Cat. no.		$I_n$ A	Cat. no.
3+NA	0.5	ST203M-D0.5NA	4	0.5	ST204M-D0.5
	1	ST203M-D1NA		1	ST204M-D1
	1.6	ST203M-D1.6NA		1.6	ST204M-D1.6
	2	ST203M-D2NA		2	ST204M-D2
	3	ST203M-D3NA		3	ST204M-D3
	4	ST203M-D4NA		4	ST204M-D4
	5	ST203M-D5NA		5	ST204M-D5
	6	ST203M-D6NA		6	ST204M-D6
	7	ST203M-D7NA		7	ST204M-D7
	8	ST203M-D8NA		8	ST204M-D8
	10	ST203M-D10NA		10	ST204M-D10
	13	ST203M-D13NA		13	ST204M-D13
	15	ST203M-D15NA		15	ST204M-D15
	16	ST203M-D16NA		16	ST204M-D16
	20	ST203M-D20NA		20	ST204M-D20
	25	ST203M-D25NA		25	ST204M-D25
	30	ST203M-D30NA		30	ST204M-D30
	32	ST203M-D32NA		32	ST204M-D32
	35	ST203M-D35NA		35	ST204M-D35
	40	ST203M-D40NA		40	ST204M-D40
	50	ST203M-D50NA		50	ST204M-D50
	60	ST203M-D60NA		60	ST204M-D60
	63	ST203M-D63NA		63	ST204M-D63

# ST200M-K

Supplemental protectors — UL 1077, CSA 22.2 No. 235

	Number of poles	Rated current		Cat. no.	Number of poles	Rated current	
		$I_n$ A				$I_n$ A	Cat. no.
	1	0.5		ST201M-K0.5	2	0.5	ST202M-K0.5
		1		ST201M-K1		1	ST202M-K1
		1.6		ST201M-K1.6		1.6	ST202M-K1.6
		2		ST201M-K2		2	ST202M-K2
		3		ST201M-K3		3	ST202M-K3
		4		ST201M-K4		4	ST202M-K4
		5		ST201M-K5		5	ST202M-K5
		6		ST201M-K6		6	ST202M-K6
		7		ST201M-K7		7	ST202M-K7
		8		ST201M-K8		8	ST202M-K8
		10		ST201M-K10		10	ST202M-K10
		13		ST201M-K13		13	ST202M-K13
		15		ST201M-K15		15	ST202M-K15
		16		ST201M-K16		16	ST202M-K16
		20		ST201M-K20		20	ST202M-K20
		25		ST201M-K25		25	ST202M-K25
		30		ST201M-K30		30	ST202M-K30
		32		ST201M-K32		32	ST202M-K32
		35		ST201M-K35		35	ST202M-K35
40		ST201M-K40	40	ST202M-K40			
50		ST201M-K50	50	ST202M-K50			
60		ST201M-K60	60	ST202M-K60			
63		ST201M-K63	63	ST202M-K63			
	1+NA	0.5		ST201M-K0.5NA	3	0.5	ST203M-K0.5
		1		ST201M-K1NA		1	ST203M-K1
		1.6		ST201M-K1.6NA		1.6	ST203M-K1.6
		2		ST201M-K2NA		2	ST203M-K2
		3		ST201M-K3NA		3	ST203M-K3
		4		ST201M-K4NA		4	ST203M-K4
		5		ST201M-K5NA		5	ST203M-K5
		6		ST201M-K6NA		6	ST203M-K6
		7		ST201M-K7NA		7	ST203M-K7
		8		ST201M-K8NA		8	ST203M-K8
		10		ST201M-K10NA		10	ST203M-K10
		13		ST201M-K13NA		13	ST203M-K13
		15		ST201M-K15NA		15	ST203M-K15
		16		ST201M-K16NA		16	ST203M-K16
		20		ST201M-K20NA		20	ST203M-K20
		25		ST201M-K25NA		25	ST203M-K25
		30		ST201M-K30NA		30	ST203M-K30
		32		ST201M-K32NA		32	ST203M-K32
		35		ST201M-K35NA		35	ST203M-K35
40		ST201M-K40NA	40	ST203M-K40			
50		ST201M-K50NA	50	ST203M-K50			
60		ST201M-K60NA	60	ST203M-K60			
63		ST201M-K63NA	63	ST203M-K63			

Diagram

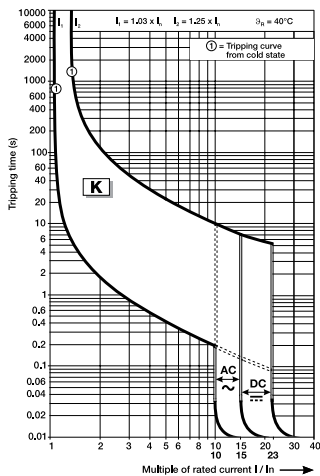



## ST200M-K (cont.)

Supplemental protectors — UL 1077, CSA 22.2 No. 235

Number of poles	Rated current		Number of poles	Rated current	
	$I_n$ A	Cat. no.		$I_n$ A	Cat. no.
3+NA	0.5	ST203M-K0.5NA	4	0.5	ST204M-K0.5
	1	ST203M-K1NA		1	ST204M-K1
	1.6	ST203M-K1.6NA		1.6	ST204M-K1.6
	2	ST203M-K2NA		2	ST204M-K2
	3	ST203M-K3NA		3	ST204M-K3
	4	ST203M-K4NA		4	ST204M-K4
	5	ST203M-K5NA		5	ST204M-K5
	6	ST203M-K6NA		6	ST204M-K6
	7	ST203M-K7NA		7	ST204M-K7
	8	ST203M-K8NA		8	ST204M-K8
	10	ST203M-K10NA		10	ST204M-K10
	13	ST203M-K13NA		13	ST204M-K13
	15	ST203M-K15NA		15	ST204M-K15
	16	ST203M-K16NA		16	ST204M-K16
	20	ST203M-K20NA		20	ST204M-K20
	25	ST203M-K25NA		25	ST204M-K25
	30	ST203M-K30NA		30	ST204M-K30
	32	ST203M-K32NA		32	ST204M-K32
	35	ST203M-K35NA		35	ST204M-K35
	40	ST203M-K40NA		40	ST204M-K40
50	ST203M-K50NA	50	ST204M-K50		
60	ST203M-K60NA	60	ST204M-K60		
63	ST203M-K63NA	63	ST204M-K63		

# ST200M-Z

Supplemental protectors — UL 1077, CSA 22.2 No. 235

	Number of poles	Rated current		Number of poles	Rated current				
		$I_n$ A	Cat. no.		$I_n$ A	Cat. no.			
	1	0.5	ST201M-Z0.5	2	0.5	ST202M-Z0.5			
		1	ST201M-Z1		1	ST202M-Z1			
		1.6	ST201M-Z1.6		1.6	ST202M-Z1.6			
		2	ST201M-Z2		2	ST202M-Z2			
		3	ST201M-Z3		3	ST202M-Z3			
		4	ST201M-Z4		4	ST202M-Z4			
		5	ST201M-Z5		5	ST202M-Z5			
		6	ST201M-Z6		6	ST202M-Z6			
		7	ST201M-Z7		7	ST202M-Z7			
		8	ST201M-Z8		8	ST202M-Z8			
		10	ST201M-Z10		10	ST202M-Z10			
		13	ST201M-Z13		13	ST202M-Z13			
		15	ST201M-Z15		15	ST202M-Z15			
		16	ST201M-Z16		16	ST202M-Z16			
		20	ST201M-Z20		20	ST202M-Z20			
		25	ST201M-Z25		25	ST202M-Z25			
		30	ST201M-Z30		30	ST202M-Z30			
			1+NA		0.5	ST201M-Z0.5NA	3	0.5	ST203M-Z0.5
					1	ST201M-Z1NA		1	ST203M-Z1
1.6	ST201M-Z1.6NA			1.6	ST203M-Z1.6				
2	ST201M-Z2NA			2	ST203M-Z2				
3	ST201M-Z3NA			3	ST203M-Z3				
4	ST201M-Z4NA			4	ST203M-Z4				
5	ST201M-Z5NA			5	ST203M-Z5				
6	ST201M-Z6NA			6	ST203M-Z6				
7	ST201M-Z7NA			7	ST203M-Z7				
8	ST201M-Z8NA			8	ST203M-Z8				
10	ST201M-Z10NA			10	ST203M-Z10				
13	ST201M-Z13NA			13	ST203M-Z13				
15	ST201M-Z15NA			15	ST203M-Z15				
16	ST201M-Z16NA			16	ST203M-Z16				
20	ST201M-Z20NA			20	ST203M-Z20				
25	ST201M-Z25NA			25	ST203M-Z25				
30	ST201M-Z30NA			30	ST203M-Z30				
32	ST201M-Z32NA			32	ST203M-Z32				
35	ST201M-Z35NA			35	ST203M-Z35				
40	ST201M-Z40NA	40	ST203M-Z40						
50	ST201M-Z50NA	50	ST203M-Z50						
60	ST201M-Z60NA	60	ST203M-Z60						
63	ST201M-Z63NA	63	ST203M-Z63						

Diagram

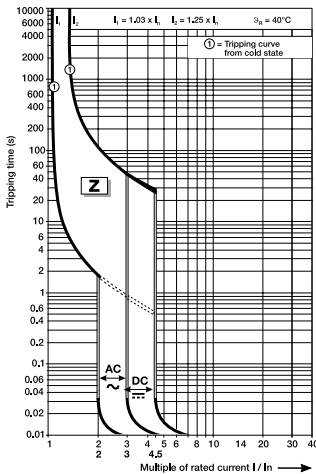

## ST200M-Z (cont.)

Supplemental protectors — UL 1077, CSA 22.2 No. 235

Rated current			Rated current		
Number of poles	$I_n$ A	Cat. no.	Number of poles	$I_n$ A	Cat. no.
3+NA	0.5	ST203M-Z0.5NA	4	0.5	ST204M-Z0.5
	1	ST203M-Z1NA		1	ST204M-Z1
	1.6	ST203M-Z1.6NA		1.6	ST204M-Z1.6
	2	ST203M-Z2NA		2	ST204M-Z2
	3	ST203M-Z3NA		3	ST204M-Z3
	4	ST203M-Z4NA		4	ST204M-Z4
	5	ST203M-Z5NA		5	ST204M-Z5
	6	ST203M-Z6NA		6	ST204M-Z6
	7	ST203M-Z7NA		7	ST204M-Z7
	8	ST203M-Z8NA		8	ST204M-Z8
	10	ST203M-Z10NA		10	ST204M-Z10
	13	ST203M-Z13NA		13	ST204M-Z13
	15	ST203M-Z15NA		15	ST204M-Z15
	16	ST203M-Z16NA		16	ST204M-Z16
	20	ST203M-Z20NA		20	ST204M-Z20
	25	ST203M-Z25NA		25	ST204M-Z25
	30	ST203M-Z30NA		30	ST204M-Z30
	32	ST203M-Z32NA		32	ST204M-Z32
	35	ST203M-Z35NA		35	ST204M-Z35
	40	ST203M-Z40NA		40	ST204M-Z40
	50	ST203M-Z50NA		50	ST204M-Z50
	60	ST203M-Z60NA		60	ST204M-Z60
	63	ST203M-Z63NA		63	ST204M-Z63

## S200MR-K with ring tongue terminals

Supplemental protectors — UL 1077, CSA 22.2 No. 235

Number of poles	Rated current		Number of poles	Rated current	
	$I_n$ A	Cat. no.		$I_n$ A	Cat. no.
1	0.2	S201MR-K0.2	3	0.2	S203MR-K0.2
	0.3	S201MR-K0.3		0.3	S203MR-K0.3
	0.5	S201MR-K0.5		0.5	S203MR-K0.5
	0.75	S201MR-K0.75		0.75	S203MR-K0.75
	1	S201MR-K1		1	S203MR-K1
	1.6	S201MR-K1.6		1.6	S203MR-K1.6
	2	S201MR-K2		2	S203MR-K2
	3	S201MR-K3		3	S203MR-K3
	4	S201MR-K4		4	S203MR-K4
	5	S201MR-K5		5	S203MR-K5
	6	S201MR-K6		6	S203MR-K6
	8	S201MR-K8		8	S203MR-K8
	10	S201MR-K10		10	S203MR-K10
	13	S201MR-K13		13	S203MR-K13
	15	S201MR-K15		15	S203MR-K15
	2	0.2		S202MR-K0.2	4
0.3		S202MR-K0.3	0.3	S204MR-K0.3	
0.5		S202MR-K0.5	0.5	S204MR-K0.5	
0.75		S202MR-K0.75	0.75	S204MR-K0.75	
1		S202MR-K1	1	S204MR-K1	
1.6		S202MR-K1.6	1.6	S204MR-K1.6	
2		S202MR-K2	2	S204MR-K2	
3		S202MR-K3	3	S204MR-K3	
4		S202MR-K4	4	S204MR-K4	
5		S202MR-K5	5	S204MR-K5	
6		S202MR-K6	6	S204MR-K6	
8		S202MR-K8	8	S204MR-K8	
10		S202MR-K10	10	S204MR-K10	
13		S202MR-K13	13	S204MR-K13	
15		S202MR-K15	15	S204MR-K15	
16		S202MR-K16	16	S204MR-K16	
20	S202MR-K20	20	S204MR-K20		
25	S202MR-K25	25	S204MR-K25		
30	S202MR-K30	30	S204MR-K30		
32	S202MR-K32	32	S204MR-K32		
35	S202MR-K35	35	S204MR-K35		
40	S202MR-K40	40	S204MR-K40		
50	S202MR-K50	50	S204MR-K50		
60	S202MR-K60	60	S204MR-K60		
63	S202MR-K63	63	S204MR-K63		



Diagram

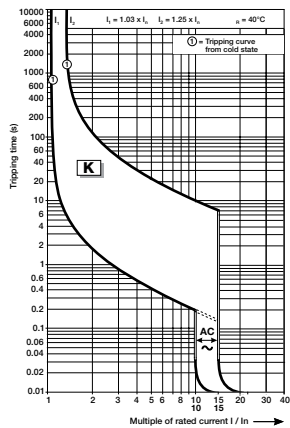

# S200MUC-C

Supplemental protectors — UL 1077, CSA 22.2 No. 235

Number of poles	Rated current		Number of poles	Rated current	
	$I_n$ A	Cat. no.		$I_n$ A	Cat. no.
1	0.5	S201MUC-C0.5	3	0.5	S203MUC-C0.5
	1	S201MUC-C1		1	S203MUC-C1
	1.6	S201MUC-C1.6		1.6	S203MUC-C1.6
	2	S201MUC-C2		2	S203MUC-C2
	3	S201MUC-C3		3	S203MUC-C3
	4	S201MUC-C4		4	S203MUC-C4
	6	S201MUC-C6		6	S203MUC-C6
	8	S201MUC-C8		8	S203MUC-C8
	10	S201MUC-C10		10	S203MUC-C10
	13	S201MUC-C13		13	S203MUC-C13
	16	S201MUC-C16		16	S203MUC-C16
	20	S201MUC-C20		20	S203MUC-C20
	25	S201MUC-C25		25	S203MUC-C25
	32	S201MUC-C32		32	S203MUC-C32
2	0.5	S202MUC-C0.5	4	0.5	S204MUC-C0.5
	1	S202MUC-C1		1	S204MUC-C1
	1.6	S202MUC-C1.6		1.6	S204MUC-C1.6
	2	S202MUC-C2		2	S204MUC-C2
	3	S202MUC-C3		3	S204MUC-C3
	4	S202MUC-C4		4	S204MUC-C4
	6	S202MUC-C6		6	S204MUC-C6
	8	S202MUC-C8		8	S204MUC-C8
	10	S202MUC-C10		10	S204MUC-C10
	13	S202MUC-C13		13	S204MUC-C13
	16	S202MUC-C16		16	S204MUC-C16
	20	S202MUC-C20		20	S204MUC-C20
	25	S202MUC-C25		25	S204MUC-C25
	32	S202MUC-C32		32	S204MUC-C32
40	S202MUC-C40	40	S204MUC-C40		
50	S202MUC-C50	50	S204MUC-C50		
63	S202MUC-C63	63	S204MUC-C63		



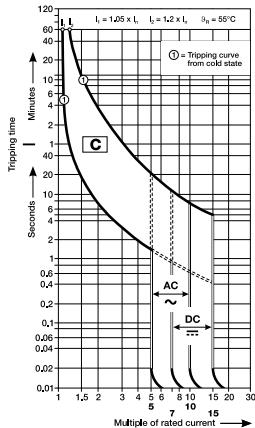

Diagram



# S200MUC-K

Supplemental protectors — UL 1077, CSA 22.2 No. 235

	Rated current			Rated current		
	Number of poles	$I_n$ A	Cat. no.	Number of poles	$I_n$ A	Cat. no.
	1	0.2	S201MUC-K0.2	3	0.2	S203MUC-K0.2
		0.3	S201MUC-K0.3		0.3	S203MUC-K0.3
		0.5	S201MUC-K0.5		0.5	S203MUC-K0.5
		0.75	S201MUC-K0.75		0.75	S203MUC-K0.75
		1	S201MUC-K1		1	S203MUC-K1
		1.6	S201MUC-K1.6		1.6	S203MUC-K1.6
		2	S201MUC-K2		2	S203MUC-K2
		3	S201MUC-K3		3	S203MUC-K3
		4	S201MUC-K4		4	S203MUC-K4
		5	S201MUC-K5		5	S203MUC-K5
		6	S201MUC-K6		6	S203MUC-K6
		8	S201MUC-K8		8	S203MUC-K8
		10	S201MUC-K10		10	S203MUC-K10
		13	S201MUC-K13		13	S203MUC-K13
		15	S201MUC-K15		15	S203MUC-K15
		16	S201MUC-K16		16	S203MUC-K16
		20	S201MUC-K20		20	S203MUC-K20
		25	S201MUC-K25		25	S203MUC-K25
		30	S201MUC-K30		30	S203MUC-K30
32	S201MUC-K32	32	S203MUC-K32			
35	S201MUC-K35	35	S203MUC-K35			
40	S201MUC-K40	40	S203MUC-K40			
50	S201MUC-K50	50	S203MUC-K50			
60	S201MUC-K60	60	S203MUC-K60			
63	S201MUC-K63	63	S203MUC-K63			
	2	0.2	S202MUC-K0.2	4	0.2	S204MUC-K0.2
		0.3	S202MUC-K0.3		0.3	S204MUC-K0.3
		0.5	S202MUC-K0.5		0.5	S204MUC-K0.5
		0.75	S202MUC-K0.75		0.75	S204MUC-K0.75
		1	S202MUC-K1		1	S204MUC-K1
		1.6	S202MUC-K1.6		1.6	S204MUC-K1.6
		2	S202MUC-K2		2	S204MUC-K2
		3	S202MUC-K3		3	S204MUC-K3
		4	S202MUC-K4		4	S204MUC-K4
		5	S202MUC-K5		5	S204MUC-K5
		6	S202MUC-K6		6	S204MUC-K6
		8	S202MUC-K8		8	S204MUC-K8
		10	S202MUC-K10		10	S204MUC-K10
		13	S202MUC-K13		13	S204MUC-K13
		15	S202MUC-K15		15	S204MUC-K15
		16	S202MUC-K16		16	S204MUC-K16
		20	S202MUC-K20		20	S204MUC-K20
		25	S202MUC-K25		25	S204MUC-K25
		30	S202MUC-K30		30	S204MUC-K30
32	S202MUC-K32	32	S204MUC-K32			
35	S202MUC-K35	35	S204MUC-K35			
40	S202MUC-K40	40	S204MUC-K40			
50	S202MUC-K50	50	S204MUC-K50			
60	S202MUC-K60	60	S204MUC-K60			
63	S202MUC-K63	63	S204MUC-K63			

**Diagram**

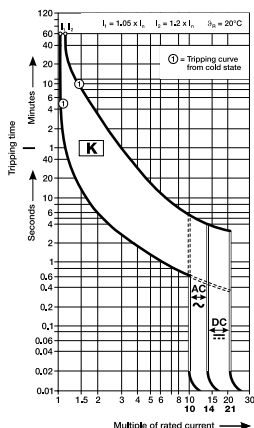

# S200MUC-Z

Supplemental protectors — UL 1077, CSA 22.2 No. 235

Number of poles	Rated current		Number of poles	Rated current	
	$I_n$ A	Cat. no.		$I_n$ A	Cat. no.
1	0.5	S201MUC-Z0.5	3	0.5	S203MUC-Z0.5
	1	S201MUC-Z1		1	S203MUC-Z1
	1.6	S201MUC-Z1.6		1.6	S203MUC-Z1.6
	2	S201MUC-Z2		2	S203MUC-Z2
	3	S201MUC-Z3		3	S203MUC-Z3
	4	S201MUC-Z4		4	S203MUC-Z4
	5	S201MUC-Z5		5	S203MUC-Z5
	6	S201MUC-Z6		6	S203MUC-Z6
	8	S201MUC-Z8		8	S203MUC-Z8
	10	S201MUC-Z10		10	S203MUC-Z10
	15	S201MUC-Z15		15	S203MUC-Z15
	16	S201MUC-Z16		16	S203MUC-Z16
	20	S201MUC-Z20		20	S203MUC-Z20
	25	S201MUC-Z25		25	S203MUC-Z25
	30	S201MUC-Z30		30	S203MUC-Z30
2	0.5	S202MUC-Z0.5	4	0.5	S204MUC-Z0.5
	1	S202MUC-Z1		1	S204MUC-Z1
	1.6	S202MUC-Z1.6		1.6	S204MUC-Z1.6
	2	S202MUC-Z2		2	S204MUC-Z2
	3	S202MUC-Z3		3	S204MUC-Z3
	4	S202MUC-Z4		4	S204MUC-Z4
	5	S202MUC-Z5		5	S204MUC-Z5
	6	S202MUC-Z6		6	S204MUC-Z6
	8	S202MUC-Z8		8	S204MUC-Z8
	10	S202MUC-Z10		10	S204MUC-Z10
	15	S202MUC-Z15		15	S204MUC-Z15
	16	S202MUC-Z16		16	S204MUC-Z16
	20	S202MUC-Z20		20	S204MUC-Z20
	25	S202MUC-Z25		25	S204MUC-Z25
	30	S202MUC-Z30		30	S204MUC-Z30
32	S202MUC-Z32	32	S204MUC-Z32		
35	S202MUC-Z35	35	S204MUC-Z35		
40	S202MUC-Z40	40	S204MUC-Z40		
50	S202MUC-Z50	50	S204MUC-Z50		
60	S202MUC-Z60	60	S204MUC-Z60		
63	S202MUC-Z63	63	S204MUC-Z63		





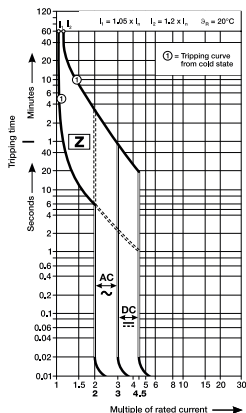

Diagram







## S800C-B

With interchangeable cage terminal

	Number of poles			Rated current [A]			Cat. no.																																			
	1	2	3	10	13	16	20	25	32	40	50	63	10	13	16	20	25	32	40	50	63																					
	1		3	10	13	16	20	25	32	40	50	63	S801C-B10	S801C-B13	S801C-B16	S801C-B20	S801C-B25	S801C-B32	S801C-B40	S801C-B50	S801C-B63	S803C-B10	S803C-B13	S803C-B16	S803C-B20	S803C-B25	S803C-B32	S803C-B40	S803C-B50	S803C-B63												
					2		4	10	13	16	20	25	32	40	50	63	S802C-B10	S802C-B13	S802C-B16	S802C-B20	S802C-B25	S802C-B32	S802C-B40	S802C-B50	S802C-B63	S804C-B10	S804C-B13	S804C-B16	S804C-B20	S804C-B25	S804C-B32	S804C-B40	S804C-B50	S804C-B63								
									3		6	10	13	16	20	25	32	40	50	63	S803C-B10	S803C-B13	S803C-B16	S803C-B20	S803C-B25	S803C-B32	S803C-B40	S803C-B50	S803C-B63	S806C-B10	S806C-B13	S806C-B16	S806C-B20	S806C-B25	S806C-B32	S806C-B40	S806C-B50	S806C-B63				
													4		8	10	13	16	20	25	32	40	50	63	S804C-B10	S804C-B13	S804C-B16	S804C-B20	S804C-B25	S804C-B32	S804C-B40	S804C-B50	S804C-B63	S808C-B10	S808C-B13	S808C-B16	S808C-B20	S808C-B25	S808C-B32	S808C-B40	S808C-B50	S808C-B63





## S800C-C

With interchangeable cage terminal

	Number of poles		Rated current [A]		Cat. no.		Number of poles		Rated current [A]		Cat. no.	
	1		10	S801C-C10	3		10	S803C-C10				
			13	S801C-C13			13	S803C-C13				
			16	S801C-C16			16	S803C-C16				
			20	S801C-C20			20	S803C-C20				
			25	S801C-C25			25	S803C-C25				
			32	S801C-C32			32	S803C-C32				
			40	S801C-C40			40	S803C-C40				
			50	S801C-C50			50	S803C-C50				
	2		10	S802C-C10	4		10	S804C-C10				
			13	S802C-C13			13	S804C-C13				
			16	S802C-C16			16	S804C-C16				
			20	S802C-C20			20	S804C-C20				
			25	S802C-C25			25	S804C-C25				
			32	S802C-C32			32	S804C-C32				
			40	S802C-C40			40	S804C-C40				
			50	S802C-C50			50	S804C-C50				
	3		10	S803C-C10	6		10	S806C-C10				
			13	S803C-C13			13	S806C-C13				
			16	S803C-C16			16	S806C-C16				
			20	S803C-C20			20	S806C-C20				
			25	S803C-C25			25	S806C-C25				
			32	S803C-C32			32	S806C-C32				
			40	S803C-C40			40	S806C-C40				
			50	S803C-C50			50	S806C-C50				
	4		10	S804C-C10	8		10	S808C-C10				
			13	S804C-C13			13	S808C-C13				
			16	S804C-C16			16	S808C-C16				
			20	S804C-C20			20	S808C-C20				
			25	S804C-C25			25	S808C-C25				
			32	S804C-C32			32	S808C-C32				
			40	S804C-C40			40	S808C-C40				
			50	S804C-C50			50	S808C-C50				





## S800C-D

With interchangeable cage terminal

	Number of poles	Rated current [A]	Cat. no.	Number of poles	Rated current [A]	Cat. no.
	1	10	S801C-D10	3	10	S803C-D10
		13	S801C-D13		13	S803C-D13
		16	S801C-D16		16	S803C-D16
		20	S801C-D20		20	S803C-D20
		25	S801C-D25		25	S803C-D25
		32	S801C-D32		32	S803C-D32
		40	S801C-D40		40	S803C-D40
		50	S801C-D50		50	S803C-D50
	2	10	S802C-D10	4	10	S804C-D10
		13	S802C-D13		13	S804C-D13
		16	S802C-D16		16	S804C-D16
		20	S802C-D20		20	S804C-D20
		25	S802C-D25		25	S804C-D25
		32	S802C-D32		32	S804C-D32
		40	S802C-D40		40	S804C-D40
		50	S802C-D50		50	S804C-D50
	3	10	S803C-D10	6	10	S806C-D10
		13	S803C-D13		13	S806C-D13
		16	S803C-D16		16	S806C-D16
		20	S803C-D20		20	S806C-D20
		25	S803C-D25		25	S806C-D25
		32	S803C-D32		32	S806C-D32
		40	S803C-D40		40	S806C-D40
		50	S803C-D50		50	S806C-D50
	4	10	S804C-D10	8	10	S808C-D10
		13	S804C-D13		13	S808C-D13
		16	S804C-D16		16	S808C-D16
		20	S804C-D20		20	S808C-D20
		25	S804C-D25		25	S808C-D25
		32	S804C-D32		32	S808C-D32
		40	S804C-D40		40	S808C-D40
		50	S804C-D50		50	S808C-D50

## S800C-K

With interchangeable cage terminal

	Number of poles			Rated current [A]			Cat. no.				
	1	2	3	10	13	16	20	25	32	40	50
	1		3	10	S801C-K10		10	S803C-K10		10	S803C-K10
				13	S801C-K13		13	S803C-K13			
				16	S801C-K16		16	S803C-K16			
				20	S801C-K20		20	S803C-K20			
				25	S801C-K25		25	S803C-K25			
				32	S801C-K32		32	S803C-K32			
				40	S801C-K40		40	S803C-K40			
	2		4	10	S802C-K10		10	S804C-K10		10	S804C-K10
				13	S802C-K13		13	S804C-K13			
				16	S802C-K16		16	S804C-K16			
				20	S802C-K20		20	S804C-K20			
				25	S802C-K25		25	S804C-K25			
				32	S802C-K32		32	S804C-K32			
				40	S802C-K40		40	S804C-K40			
				10	S803C-K10		10	S805C-K10		10	S805C-K10
				13	S803C-K13		13	S805C-K13			
				16	S803C-K16		16	S805C-K16			
				20	S803C-K20		20	S805C-K20			
				25	S803C-K25		25	S805C-K25			
				10	S804C-K10		10	S806C-K10		10	S806C-K10
				13	S804C-K13		13	S806C-K13			
				16	S804C-K16		16	S806C-K16			
				20	S804C-K20		20	S806C-K20			
				25	S804C-K25		25	S806C-K25			

## S800S-B

With interchangeable cage terminal





	Number of poles	Rated current		Number of poles	Rated current	
		$I_n$ A	Cat. no.		$I_n$ A	Cat. no.
	1	0.5	S801S-B0.5	3	0.5	S803S-B0.5
		1	S801S-B1		1	S803S-B1
		1.6	S801S-B1.6		1.6	S803S-B1.6
		2	S801S-B2		2	S803S-B2
		2.5	S801S-B2.5		2.5	S803S-B2.5
		3	S801S-B3		3	S803S-B3
		4	S801S-B4		4	S803S-B4
		5	S801S-B5		5	S803S-B5
		6	S801S-B6		6	S803S-B6
		8	S801S-B8		8	S803S-B8
		10	S801S-B10		10	S803S-B10
		13	S801S-B13		13	S803S-B13
		16	S801S-B16		16	S803S-B16
		20	S801S-B20		20	S803S-B20
		25	S801S-B25		25	S803S-B25
		  	2		0.5	S802S-B0.5
1	S802S-B1			1	S804S-B1	
1.6	S802S-B1.6			1.6	S804S-B1.6	
2	S802S-B2			2	S804S-B2	
2.5	S802S-B2.5			2.5	S804S-B2.5	
3	S802S-B3			3	S804S-B3	
4	S802S-B4			4	S804S-B4	
5	S802S-B5			5	S804S-B5	
6	S802S-B6			6	S804S-B6	
8	S802S-B8			8	S804S-B8	
10	S802S-B10			10	S804S-B10	
13	S802S-B13			13	S804S-B13	
16	S802S-B16			16	S804S-B16	
20	S802S-B20			20	S804S-B20	
25	S802S-B25			25	S804S-B25	
32	S802S-B32			32	S804S-B32	
40	S802S-B40	40	S804S-B40			
50	S802S-B50	50	S804S-B50			
63	S802S-B63	63	S804S-B63			

ABB Products Proudly Distributed by Gross Automation.

Please call +1 (262) 252-1600 or email [sales@grossautomation.com](mailto:sales@grossautomation.com).

## S800S-C

With interchangeable cage terminal





	Number of poles	Rated current		Number of poles	Rated current	
		$I_n$ A	Cat. no.		$I_n$ A	Cat. no.
	1	0.5	S801S-C0.5	3	0.5	S803S-C0.5
		1	S801S-C1		1	S803S-C1
		1.6	S801S-C1.6		1.6	S803S-C1.6
		2	S801S-C2		2	S803S-C2
		2.5	S801S-C2.5		2.5	S803S-C2.5
		3	S801S-C3		3	S803S-C3
		4	S801S-C4		4	S803S-C4
		5	S801S-C5		5	S803S-C5
		6	S801S-C6		6	S803S-C6
		8	S801S-C8		8	S803S-C8
		10	S801S-C10		10	S803S-C10
		13	S801S-C13		13	S803S-C13
		16	S801S-C16		16	S803S-C16
		20	S801S-C20		20	S803S-C20
		25	S801S-C25		25	S803S-C25
		  	2		0.5	S802S-C0.5
1	S802S-C1			1	S804S-C1	
1.6	S802S-C1.6			1.6	S804S-C1.6	
2	S802S-C2			2	S804S-C2	
2.5	S802S-C2.5			2.5	S804S-C2.5	
3	S802S-C3			3	S804S-C3	
4	S802S-C4			4	S804S-C4	
5	S802S-C5			5	S804S-C5	
6	S802S-C6			6	S804S-C6	
8	S802S-C8			8	S804S-C8	
10	S802S-C10			10	S804S-C10	
13	S802S-C13			13	S804S-C13	
16	S802S-C16			16	S804S-C16	
20	S802S-C20			20	S804S-C20	
25	S802S-C25			25	S804S-C25	
32	S802S-C32			32	S804S-C32	
40	S802S-C40	40	S804S-C40			
50	S802S-C50	50	S804S-C50			
63	S802S-C63	63	S804S-C63			

ABB Products Proudly Distributed by Gross Automation.

Please call +1 (262) 252-1600 or email [sales@grossautomation.com](mailto:sales@grossautomation.com).

## S800S-D

With interchangeable cage terminal



Number of poles	Rated current		Number of poles	Rated current			
	$I_n$ A	Cat. no.		$I_n$ A	Cat. no.		
	1	0.5	S801S-D0.5		3	0.5	S803S-D0.5
		1	S801S-D1			1	S803S-D1
		1.6	S801S-D1.6			1.6	S803S-D1.6
		2	S801S-D2			2	S803S-D2
		2.5	S801S-D2.5			2.5	S803S-D2.5
		3	S801S-D3			3	S803S-D3
		4	S801S-D4			4	S803S-D4
		5	S801S-D5			5	S803S-D5
		6	S801S-D6			6	S803S-D6
		8	S801S-D8			8	S803S-D8
		10	S801S-D10			10	S803S-D10
		13	S801S-D13			13	S803S-D13
		16	S801S-D16			16	S803S-D16
		20	S801S-D20			20	S803S-D20
		25	S801S-D25			25	S803S-D25
			2			0.5	S802S-D0.5
1	S802S-D1			1	S804S-D1		
1.6	S802S-D1.6			1.6	S804S-D1.6		
2	S802S-D2			2	S804S-D2		
2.5	S802S-D2.5			2.5	S804S-D2.5		
3	S802S-D3			3	S804S-D3		
4	S802S-D4			4	S804S-D4		
5	S802S-D5			5	S804S-D5		
6	S802S-D6			6	S804S-D6		
8	S802S-D8			8	S804S-D8		
10	S802S-D10			10	S804S-D10		
13	S802S-D13			13	S804S-D13		
16	S802S-D16			16	S804S-D16		
20	S802S-D20			20	S804S-D20		
25	S802S-D25			25	S804S-D25		
32	S802S-D32			32	S804S-D32		
40	S802S-D40	40	S804S-D40				
50	S802S-D50	50	S804S-D50				
63	S802S-D63	63	S804S-D63				

ABB Products Proudly Distributed by Gross Automation.

Please call +1 (262) 252-1600 or email [sales@grossautomation.com](mailto:sales@grossautomation.com).

## S800S-K

With interchangeable cage terminal





	Number of poles	Rated current		Number of poles	Rated current	
		$I_n$ A	Cat. no.		$I_n$ A	Cat. no.
	1	0.5	S801S-K0.5	3	0.5	S803S-K0.5
		1	S801S-K1		1	S803S-K1
		1.6	S801S-K1.6		1.6	S803S-K1.6
		2	S801S-K2		2	S803S-K2
		2.5	S801S-K2.5		2.5	S803S-K2.5
		3	S801S-K3		3	S803S-K3
		4	S801S-K4		4	S803S-K4
		5	S801S-K5		5	S803S-K5
		6	S801S-K6		6	S803S-K6
		8	S801S-K8		8	S803S-K8
		10	S801S-K10		10	S803S-K10
		13	S801S-K13		13	S803S-K13
		16	S801S-K16		16	S803S-K16
		20	S801S-K20		20	S803S-K20
		25	S801S-K25		25	S803S-K25
		  	2		0.5	S802S-K0.5
1	S802S-K1			1	S804S-K1	
1.6	S802S-K1.6			1.6	S804S-K1.6	
2	S802S-K2			2	S804S-K2	
2.5	S802S-K2.5			2.5	S804S-K2.5	
3	S802S-K3			3	S804S-K3	
4	S802S-K4			4	S804S-K4	
5	S802S-K5			5	S804S-K5	
6	S802S-K6			6	S804S-K6	
8	S802S-K8			8	S804S-K8	
10	S802S-K10			10	S804S-K10	
13	S802S-K13			13	S804S-K13	
16	S802S-K16			16	S804S-K16	
20	S802S-K20			20	S804S-K20	
25	S802S-K25			25	S804S-K25	
32	S802S-K32			32	S804S-K32	
40	S802S-K40	40	S804S-K40			
50	S802S-K50	50	S804S-K50			
63	S802S-K63	63	S804S-K63			

ABB Products Proudly Distributed by Gross Automation.

Please call +1 (262) 252-1600 or email [sales@grossautomation.com](mailto:sales@grossautomation.com).

## S800P

With interchangeable cage terminal

### S800P-B



Number of poles	Rated current $I_n$ A	Cat no.	Number of poles	Rated current $I_n$ A	Cat no.
1	80	S801P-B80	2	80	S802P-B80
	100	S801P-B100		100	S802P-B100
3	80	S803P-B80	4	80	S804P-B80
	100	S803P-B100		100	S804P-B100

### S800P-C



Number of poles	Rated current $I_n$ A	Cat no.	Number of poles	Rated current $I_n$ A	Cat no.
1	80	S801P-C80	2	80	S802P-C80
	100	S801P-C100		100	S802P-C100
3	80	S803P-C80	4	80	S804P-C80
	100	S803P-C100		100	S804P-C100

### S800P-D



Number of poles	Rated current $I_n$ A	Cat no.	Number of poles	Rated current $I_n$ A	Cat no.
1	80	S801P-D80	2	80	S802P-D80
	100	S801P-D100		100	S802P-D100
3	80	S803P-D80	4	80	S804P-D80
	100	S803P-D100		100	S804P-D100

### S800P-K



Number of poles	Rated current $I_n$ A	Cat no.	Number of poles	Rated current $I_n$ A	Cat no.
1	80	S801P-K80	2	80	S802P-K80
	100	S801P-K100		100	S802P-K100
3	80	S803P-K80	4	80	S804P-K80
	100	S803P-K100		100	S804P-K100

## S300P-B

UL 1077, CSA 22.2 No. 235

### S300P-B characteristics

Function: Protection and control of circuits against overloads and short circuits; protection for people and long lengths of cables in TN and IT systems.

Standards: UL 1077, IEC/EN 60898-1, IEC/EN 60947-2

UL 1077 interrupt rating: 10 kA





	Number of poles	Rated current		Number of poles	Rated current	
		$I_n$ A	Cat. no.		$I_n$ A	Cat. no.
	1	6	S301P-B6	3	6	S303P-B6
		8	S301P-B8		8	S303P-B8
		10	S301P-B10		10	S303P-B10
		13	S301P-B13		13	S303P-B13
		16	S301P-B16		16	S303P-B16
		20	S301P-B20		20	S303P-B20
		25	S301P-B25		25	S303P-B25
		32	S301P-B32		32	S303P-B32
	2	6	S302P-B6	4	6	S304P-B6
		8	S302P-B8		8	S304P-B8
		10	S302P-B10		10	S304P-B10
		13	S302P-B13		13	S304P-B13
		16	S302P-B16		16	S304P-B16
		20	S302P-B20		20	S304P-B20
		25	S302P-B25		25	S304P-B25
		32	S302P-B32		32	S304P-B32
	3	6	S303P-B6	4	6	S304P-B6
		8	S303P-B8		8	S304P-B8
		10	S303P-B10		10	S304P-B10
		13	S303P-B13		13	S304P-B13
		16	S303P-B16		16	S304P-B16
		20	S303P-B20		20	S304P-B20
		25	S303P-B25		25	S304P-B25
		32	S303P-B32		32	S304P-B32
	4	6	S304P-B6	4	6	S304P-B6
		8	S304P-B8		8	S304P-B8
		10	S304P-B10		10	S304P-B10
		13	S304P-B13		13	S304P-B13
		16	S304P-B16		16	S304P-B16
		20	S304P-B20		20	S304P-B20
		25	S304P-B25		25	S304P-B25
		32	S304P-B32		32	S304P-B32

ABB Products Proudly Distributed by Gross Automation.

Please call +1 (262) 252-1600 or email [sales@grossautomation.com](mailto:sales@grossautomation.com).

## S300P-C





UL 1077, CSA 22.2 No. 235

### S300P-C characteristics

Function: Protection and control of circuits against overloads and short circuits; protection for people and long lengths of cables in TN and IT systems.

Standards: UL 1077, IEC/EN 60898-1, IEC/EN 60947-2

UL 1077 interrupt rating: 10 kA

	Number of poles	Rated current		Number of poles	Rated current	
		$I_n$ A	Cat. no.		$I_n$ A	Cat. no.
	1	0.5	S301P-C0,5	3	0.5	S303P-C0,5
		1	S301P-C1		1	S303P-C1
		1.6	S301P-C1,6		1.6	S303P-C1,6
		2	S301P-C2		2	S303P-C2
		3	S301P-C3		3	S303P-C3
		4	S301P-C4		4	S303P-C4
		6	S301P-C6		6	S303P-C6
		8	S301P-C8		8	S303P-C8
		10	S301P-C10		10	S303P-C10
		13	S301P-C13		13	S303P-C13
		16	S301P-C16		16	S303P-C16
		20	S301P-C20		20	S303P-C20
		25	S301P-C25		25	S303P-C25
		32	S301P-C32		32	S303P-C32
40	S301P-C40	40	S303P-C40			
50	S301P-C50	50	S303P-C50			
63	S301P-C63	63	S303P-C63			
	2	0.5	S302P-C0,5	4	0.5	S304P-C0,5
		1	S302P-C1		1	S304P-C1
		1.6	S302P-C1,6		1.6	S304P-C1,6
		2	S302P-C2		2	S304P-C2
		3	S302P-C3		3	S304P-C3
		4	S302P-C4		4	S304P-C4
		6	S302P-C6		6	S304P-C6
		8	S302P-C8		8	S304P-C8
		10	S302P-C10		10	S304P-C10
		13	S302P-C13		13	S304P-C13
		16	S302P-C16		16	S304P-C16
		20	S302P-C20		20	S304P-C20
		25	S302P-C25		25	S304P-C25
		32	S302P-C32		32	S304P-C32
40	S302P-C40	40	S304P-C40			
50	S302P-C50	50	S304P-C50			
63	S302P-C63	63	S304P-C63			
	3	0.5	S303P-C0,5	4	0.5	S304P-C0,5
		1	S303P-C1		1	S304P-C1
		1.6	S303P-C1,6		1.6	S304P-C1,6
		2	S303P-C2		2	S304P-C2
		3	S303P-C3		3	S304P-C3
		4	S303P-C4		4	S304P-C4
		6	S303P-C6		6	S304P-C6
		8	S303P-C8		8	S304P-C8
		10	S303P-C10		10	S304P-C10
		13	S303P-C13		13	S304P-C13
		16	S303P-C16		16	S304P-C16
		20	S303P-C20		20	S304P-C20
		25	S303P-C25		25	S304P-C25
		32	S303P-C32		32	S304P-C32
40	S303P-C40	40	S304P-C40			
50	S303P-C50	50	S304P-C50			
63	S303P-C63	63	S304P-C63			
	4	0.5	S304P-C0,5	4	0.5	S304P-C0,5
		1	S304P-C1		1	S304P-C1
		1.6	S304P-C1,6		1.6	S304P-C1,6
		2	S304P-C2		2	S304P-C2
		3	S304P-C3		3	S304P-C3
		4	S304P-C4		4	S304P-C4
		6	S304P-C6		6	S304P-C6
		8	S304P-C8		8	S304P-C8
		10	S304P-C10		10	S304P-C10
		13	S304P-C13		13	S304P-C13
		16	S304P-C16		16	S304P-C16
		20	S304P-C20		20	S304P-C20
		25	S304P-C25		25	S304P-C25
		32	S304P-C32		32	S304P-C32
40	S304P-C40	40	S304P-C40			
50	S304P-C50	50	S304P-C50			
63	S304P-C63	63	S304P-C63			

## S300P-D

UL 1077, CSA 22.2 No. 235

### S300P-D characteristics

Function: Protection and control of circuits against overloads and short circuits; protection for people and long lengths of cables in TN and IT systems.

Standards: UL 1077, IEC/EN 60898-1, IEC/EN 60947-2

UL 1077 interrupt rating: 10 kA

Number of poles	Rated current		Number of poles	Rated current	
	$I_n$ A	Cat. no.		$I_n$ A	Cat. no.
1	0.5	S301P-D0,5	3	0.5	S303P-D0,5
	1	S301P-D1		1	S303P-D1
	1.6	S301P-D1,6		1.6	S303P-D1,6
	2	S301P-D2		2	S303P-D2
	3	S301P-D3		3	S303P-D3
	4	S301P-D4		4	S303P-D4
	6	S301P-D6		6	S303P-D6
	8	S301P-D8		8	S303P-D8
	10	S301P-D10		10	S303P-D10
	13	S301P-D13		13	S303P-D13
	16	S301P-D16		16	S303P-D16
	20	S301P-D20		20	S303P-D20
	25	S301P-D25		25	S303P-D25
	32	S301P-D32		32	S303P-D32
40	S301P-D40	40	S303P-D40		
50	S301P-D50	50	S303P-D50		
63	S301P-D63	63	S303P-D63		
2	0.5	S302P-D0,5	4	0.5	S304P-D0,5
	1	S302P-D1		1	S304P-D1
	1.6	S302P-D1,6		1.6	S304P-D1,6
	2	S302P-D2		2	S304P-D2
	3	S302P-D3		3	S304P-D3
	4	S302P-D4		4	S304P-D4
	6	S302P-D6		6	S304P-D6
	8	S302P-D8		8	S304P-D8
	10	S302P-D10		10	S304P-D10
	13	S302P-D13		13	S304P-D13
	16	S302P-D16		16	S304P-D16
	20	S302P-D20		20	S304P-D20
	25	S302P-D25		25	S304P-D25
	32	S302P-D32		32	S304P-D32
40	S302P-D40	40	S304P-D40		
50	S302P-D50	50	S304P-D50		
63	S302P-D63	63	S304P-D63		







## S300P-K

UL 1077, CSA 22.2 No. 235

### S300P-K (power) characteristics

Function: Protection and control of circuits like motors, transformers and auxiliary circuits, against overloads and short circuits.  
Advantages: No nuisance tripping in the case of functional peak currents up to 10xI<sub>n</sub>. Depending on the series; through its highly sensitive thermostatic bimetal trip, the K-type characteristic offers protection to damageable elements in the overcurrent range; it also provides the best protection to cables and lines.

**UL 1077 interrupt rating: 10 kA**

Number of poles	Rated current		Number of poles	Rated current		
	I <sub>n</sub> A	Cat. no.		I <sub>n</sub> A	Cat. no.	
1		0.2	S301P-K0.2	3	0.2	S303P-K0.2
		0.3	S301P-K0.3		0.3	S303P-K0.3
		0.5	S301P-K0,5		0.5	S303P-K0,5
		0.75	S301P-K0.75		0.75	S303P-K0.75
		1	S301P-K1		1	S303P-K1
		1.6	S301P-K1,6		1.6	S303P-K1,6
		2	S301P-K2		2	S303P-K2
		3	S301P-K3		3	S303P-K3
		4	S301P-K4		4	S303P-K4
		6	S301P-K6		6	S303P-K6
		8	S301P-K8		8	S303P-K8
		10	S301P-K10		10	S303P-K10
		13	S301P-K13		13	S303P-K13
		16	S301P-K16		16	S303P-K16
		20	S301P-K20		20	S303P-K20
2		0.2	S302P-K0.2	4	0.2	S304P-K0.2
		0.3	S302P-K0.3		0.3	S304P-K0.3
		0.5	S302P-K0,5		0.5	S304P-K0,5
		0.75	S302P-K0.75		0.75	S304P-K0.75
		1	S302P-K1		1	S304P-K1
		1.6	S302P-K1,6		1.6	S304P-K1,6
		2	S302P-K2		2	S304P-K2
		3	S302P-K3		3	S304P-K3
		4	S302P-K4		4	S304P-K4
		6	S302P-K6		6	S304P-K6
		8	S302P-K8		8	S304P-K8
		10	S302P-K10		10	S304P-K10
		13	S302P-K13		13	S304P-K13
		16	S302P-K16		16	S304P-K16
		20	S302P-K20		20	S304P-K20
3		0.2	S303P-K0.2	6	0.2	S306P-K0.2
		0.3	S303P-K0.3		0.3	S306P-K0.3
		0.5	S303P-K0,5		0.5	S306P-K0,5
		0.75	S303P-K0.75		0.75	S306P-K0.75
		1	S303P-K1		1	S306P-K1
		1.6	S303P-K1,6		1.6	S306P-K1,6
		2	S303P-K2		2	S306P-K2
		3	S303P-K3		3	S306P-K3
		4	S303P-K4		4	S306P-K4
		6	S303P-K6		6	S306P-K6
		8	S303P-K8		8	S306P-K8
		10	S303P-K10		10	S306P-K10
		13	S303P-K13		13	S306P-K13
		16	S303P-K16		16	S306P-K16
		20	S303P-K20		20	S306P-K20
4		0.2	S304P-K0.2	8	0.2	S308P-K0.2
		0.3	S304P-K0.3		0.3	S308P-K0.3
		0.5	S304P-K0,5		0.5	S308P-K0,5
		0.75	S304P-K0.75		0.75	S308P-K0.75
		1	S304P-K1		1	S308P-K1
		1.6	S304P-K1,6		1.6	S308P-K1,6
		2	S304P-K2		2	S308P-K2
		3	S304P-K3		3	S308P-K3
		4	S304P-K4		4	S308P-K4
		6	S304P-K6		6	S308P-K6
		8	S304P-K8		8	S308P-K8
		10	S304P-K10		10	S308P-K10
		13	S304P-K13		13	S308P-K13
		16	S304P-K16		16	S308P-K16
		20	S304P-K20		20	S308P-K20
25	S304P-K25	25	S308P-K25			
32	S304P-K32	32	S308P-K32			
40	S304P-K40	40	S308P-K40			
50	S304P-K50	50	S308P-K50			
63	S304P-K63	63	S308P-K63			

**ABB Products Proudly Distributed by Gross Automation.**

**Please call +1 (262) 252-1600 or email [sales@grossautomation.com](mailto:sales@grossautomation.com).**

## S300P-Z



UL 1077, CSA 22.2 No. 235

### S300P-Z characteristics

Function: Protection and control of electronic circuits against lower and long duration overloads and short circuits.

Standards: **UL1077, IEC/EN 60947-2**

**UL 1077 interrupt rating: 10 kA**

	Rated current			Rated current		
	Number of poles	$I_n$ A	Cat. no.	Number of poles	$I_n$ A	Cat. no.
	1	0.5	S301P-Z0,5	3	0.5	S303P-Z0,5
		1	S301P-Z1		1	S303P-Z1
		1.6	S301P-Z1,6		1.6	S303P-Z1,6
		2	S301P-Z2		2	S303P-Z2
		3	S301P-Z3		3	S303P-Z3
		4	S301P-Z4		4	S303P-Z4
		6	S301P-Z6		6	S303P-Z6
		8	S301P-Z8		8	S303P-Z8
		10	S301P-Z10		10	S303P-Z10
		16	S301P-Z16		16	S303P-Z16
		20	S301P-Z20		20	S303P-Z20
		25	S301P-Z25		25	S303P-Z25
		32	S301P-Z32		32	S303P-Z32
		40	S301P-Z40		40	S303P-Z40
		50	S301P-Z50		50	S303P-Z50
63	S301P-Z63	63	S303P-Z63			
	2	0.5	S302P-Z0,5	4	0.5	S304P-Z0,5
		1	S302P-Z1		1	S304P-Z1
		1.6	S302P-Z1,6		1.6	S304P-Z1,6
		2	S302P-Z2		2	S304P-Z2
		3	S302P-Z3		3	S304P-Z3
		4	S302P-Z4		4	S304P-Z4
		6	S302P-Z6		6	S304P-Z6
		8	S302P-Z8		8	S304P-Z8
		10	S302P-Z10		10	S304P-Z10
		16	S302P-Z16		16	S304P-Z16
		20	S302P-Z20		20	S304P-Z20
		25	S302P-Z25		25	S304P-Z25
		32	S302P-Z32		32	S304P-Z32
		40	S302P-Z40		40	S304P-Z40
		50	S302P-Z50		50	S304P-Z50
63	S302P-Z63	63	S304P-Z63			

**ABB Products Proudly Distributed by Gross Automation.**

**Please call +1 (262) 252-1600 or email [sales@grossautomation.com](mailto:sales@grossautomation.com).**

## ST200MTR — ring tongue terminal

K characteristic





Number of poles	Rated current		Number of poles	Rated current			
	$I_n$ A	Cat. no.		$I_n$ A	Cat. no.		
	1	0.5	3	0.5	ST201MTR-K0,5	0.5	ST203MTR-K0,5
		1		ST201MTR-K1	1	ST203MTR-K1	
		1.6		ST201MTR-K1,6	1.6	ST203MTR-K1,6	
		2		ST201MTR-K2	2	ST203MTR-K2	
		3		ST201MTR-K3	3	ST203MTR-K3	
		4		ST201MTR-K4	4	ST203MTR-K4	
		5		ST201MTR-K5	5	ST203MTR-K5	
		6		ST201MTR-K6	6	ST203MTR-K6	
		8		ST201MTR-K8	8	ST203MTR-K8	
		10		ST201MTR-K10	10	ST203MTR-K10	
		13		ST201MTR-K13	13	ST203MTR-K13	
		15		ST201MTR-K15	15	ST203MTR-K15	
		16		ST201MTR-K16	16	ST203MTR-K16	
		20		ST201MTR-K20	20	ST203MTR-K20	
		25		ST201MTR-K25	25	ST203MTR-K25	
		30		ST201MTR-K30	30	ST203MTR-K30	
		2		0.5	4	0.5	ST202MTR-K0,5
			1	ST202MTR-K1		1	ST204MTR-K1
			1.6	ST202MTR-K1,6		1.6	ST204MTR-K1,6
			2	ST202MTR-K2		2	ST204MTR-K2
			3	ST202MTR-K3		3	ST204MTR-K3
			4	ST202MTR-K4		4	ST204MTR-K4
			5	ST202MTR-K5		5	ST204MTR-K5
			6	ST202MTR-K6		6	ST204MTR-K6
			8	ST202MTR-K8		8	ST204MTR-K8
			10	ST202MTR-K10		10	ST204MTR-K10
			13	ST202MTR-K13		13	ST204MTR-K13
			15	ST202MTR-K15		15	ST204MTR-K15
			16	ST202MTR-K16		16	ST204MTR-K16
			20	ST202MTR-K20		20	ST204MTR-K20
			25	ST202MTR-K25		25	ST204MTR-K25
			30	ST202MTR-K30		30	ST204MTR-K30
			3	0.5		4	0.5
		1		ST203MTR-K1	1		ST204MTR-K1
		1.6		ST203MTR-K1,6	1.6		ST204MTR-K1,6
		2		ST203MTR-K2	2		ST204MTR-K2
		3		ST203MTR-K3	3		ST204MTR-K3
		4		ST203MTR-K4	4		ST204MTR-K4
		5		ST203MTR-K5	5		ST204MTR-K5
		6		ST203MTR-K6	6		ST204MTR-K6
		8		ST203MTR-K8	8		ST204MTR-K8
		10		ST203MTR-K10	10		ST204MTR-K10
		13		ST203MTR-K13	13		ST204MTR-K13
		15		ST203MTR-K15	15		ST204MTR-K15
		16		ST203MTR-K16	16		ST204MTR-K16
		20		ST203MTR-K20	20		ST204MTR-K20
		25		ST203MTR-K25	25		ST204MTR-K25
		30		ST203MTR-K30	30		ST204MTR-K30
		4		0.5	4		0.5
			1	ST204MTR-K1		1	ST204MTR-K1
			1.6	ST204MTR-K1,6		1.6	ST204MTR-K1,6
			2	ST204MTR-K2		2	ST204MTR-K2
			3	ST204MTR-K3		3	ST204MTR-K3
			4	ST204MTR-K4		4	ST204MTR-K4
			5	ST204MTR-K5		5	ST204MTR-K5
			6	ST204MTR-K6		6	ST204MTR-K6
			8	ST204MTR-K8		8	ST204MTR-K8
			10	ST204MTR-K10		10	ST204MTR-K10
			13	ST204MTR-K13		13	ST204MTR-K13
			15	ST204MTR-K15		15	ST204MTR-K15
			16	ST204MTR-K16		16	ST204MTR-K16
			20	ST204MTR-K20		20	ST204MTR-K20
			25	ST204MTR-K25		25	ST204MTR-K25
			30	ST204MTR-K30		30	ST204MTR-K30
			32	ST204MTR-K32		32	ST204MTR-K32
	35	ST204MTR-K35	35	ST204MTR-K35			
	40	ST204MTR-K40	40	ST204MTR-K40			
	50	ST204MTR-K50	50	ST204MTR-K50			
	60	ST204MTR-K60	60	ST204MTR-K60			
	63	ST204MTR-K63	63	ST204MTR-K60			

ABB Products Proudly Distributed by Gross Automation.

Please call +1 (262) 252-1600 or email [sales@grossautomation.com](mailto:sales@grossautomation.com).

## ST200MTR — ring tongue terminal

K characteristic — DC

Number of poles	Rated current		Cat. no.	Number of poles	Rated current		Cat. no.
	$I_n$ A				$I_n$ A		
1	0.5	ST201MTR-K0,5 DC	4	0.5	ST204MTR-K0,5 DC		
	1	ST201MTR-K1 DC		1	ST204MTR-K1 DC		
	1.6	ST201MTR-K1,6 DC		1.6	ST204MTR-K1,6 DC		
	2	ST201MTR-K2 DC		2	ST204MTR-K2 DC		
	3	ST201MTR-K3 DC		3	ST204MTR-K3 DC		
	4	ST201MTR-K4 DC		4	ST204MTR-K4 DC		
	5	ST201MTR-K5 DC		5	ST204MTR-K5 DC		
	6	ST201MTR-K6 DC		6	ST204MTR-K6 DC		
	8	ST201MTR-K8 DC		8	ST204MTR-K8 DC		
	10	ST201MTR-K10 DC		10	ST204MTR-K10 DC		
	13	ST201MTR-K13 DC		13	ST204MTR-K13 DC		
	15	ST201MTR-K15 DC		15	ST204MTR-K15 DC		
	16	ST201MTR-K16 DC		16	ST204MTR-K16 DC		
	20	ST201MTR-K20 DC		20	ST204MTR-K20 DC		
	25	ST201MTR-K25 DC		25	ST204MTR-K25 DC		
	30	ST201MTR-K30 DC		30	ST204MTR-K30 DC		
	32	ST201MTR-K32 DC		32	ST204MTR-K32 DC		
	35	ST201MTR-K35 DC		35	ST204MTR-K35 DC		
	40	ST201MTR-K40 DC		40	ST204MTR-K40 DC		
50	ST201MTR-K50 DC	50	ST204MTR-K50 DC				
60	ST201MTR-K60 DC	60	ST204MTR-K60 DC				
63	ST201MTR-K63 DC	63	ST204MTR-K63 DC				
2	0.5	ST202MTR-K0,5 DC					
	1	ST202MTR-K1 DC					
	1.6	ST202MTR-K1,6 DC					
	2	ST202MTR-K2 DC					
	3	ST202MTR-K3 DC					
	4	ST202MTR-K4 DC					
	5	ST202MTR-K5 DC					
	6	ST202MTR-K6 DC					
	8	ST202MTR-K8 DC					
	10	ST202MTR-K10 DC					
	13	ST202MTR-K13 DC					
	15	ST202MTR-K15 DC					
	16	ST202MTR-K16 DC					
	20	ST202MTR-K20 DC					
	25	ST202MTR-K25 DC					
30	ST202MTR-K30 DC						
32	ST202MTR-K32 DC						
35	ST202MTR-K35 DC						
40	ST202MTR-K40 DC						
50	ST202MTR-K50 DC						
60	ST202MTR-K60 DC						
63	ST202MTR-K63 DC						

Please consider polarity as note above the codes.

## ST200MTR — ring tongue terminal

Z characteristic





	Number of poles	Rated current		Number of poles	Rated current	
		$I_n$ A	Cat. no.		$I_n$ A	Cat. no.
	1	0.5	ST201MTR-Z0,5	3	0.5	ST203MTR-Z0,5
		1	ST201MTR-Z1		1	ST203MTR-Z1
		1.6	ST201MTR-Z1,6		1.6	ST203MTR-Z1,6
		2	ST201MTR-Z2		2	ST203MTR-Z2
		3	ST201MTR-Z3		3	ST203MTR-Z3
		4	ST201MTR-Z4		4	ST203MTR-Z4
		5	ST201MTR-Z5		5	ST203MTR-Z5
		6	ST201MTR-Z6		6	ST203MTR-Z6
		8	ST201MTR-Z8		8	ST203MTR-Z8
		10	ST201MTR-Z10		10	ST203MTR-Z10
		15	ST201MTR-Z15		15	ST203MTR-Z15
		16	ST201MTR-Z16		16	ST203MTR-Z16
		20	ST201MTR-Z20		20	ST203MTR-Z20
		25	ST201MTR-Z25		25	ST203MTR-Z25
			3		0.5	ST201MTR-Z0,5
1	ST201MTR-Z1			1	ST203MTR-Z1	
1.6	ST201MTR-Z1,6			1.6	ST203MTR-Z1,6	
2	ST201MTR-Z2			2	ST203MTR-Z2	
3	ST201MTR-Z3			3	ST203MTR-Z3	
4	ST201MTR-Z4			4	ST203MTR-Z4	
5	ST201MTR-Z5			5	ST203MTR-Z5	
6	ST201MTR-Z6			6	ST203MTR-Z6	
8	ST201MTR-Z8			8	ST203MTR-Z8	
10	ST201MTR-Z10			10	ST203MTR-Z10	
15	ST201MTR-Z15			15	ST203MTR-Z15	
16	ST201MTR-Z16			16	ST203MTR-Z16	
20	ST201MTR-Z20			20	ST203MTR-Z20	
25	ST201MTR-Z25			25	ST203MTR-Z25	
	2			0.5	ST202MTR-Z0,5	4
		1	ST202MTR-Z1	1	ST204MTR-Z1	
		1.6	ST202MTR-Z1,6	1.6	ST204MTR-Z1,6	
		2	ST202MTR-Z2	2	ST204MTR-Z2	
		3	ST202MTR-Z3	3	ST204MTR-Z3	
		4	ST202MTR-Z4	4	ST204MTR-Z4	
		5	ST202MTR-Z5	5	ST204MTR-Z5	
		6	ST202MTR-Z6	6	ST204MTR-Z6	
		8	ST202MTR-Z8	8	ST204MTR-Z8	
		10	ST202MTR-Z10	10	ST204MTR-Z10	
		15	ST202MTR-Z15	15	ST204MTR-Z15	
		16	ST202MTR-Z16	16	ST204MTR-Z16	
		20	ST202MTR-Z20	20	ST204MTR-Z20	
		25	ST202MTR-Z25	25	ST204MTR-Z25	
			4	0.5	ST202MTR-Z0,5	
1	ST202MTR-Z1			1	ST204MTR-Z1	
1.6	ST202MTR-Z1,6			1.6	ST204MTR-Z1,6	
2	ST202MTR-Z2			2	ST204MTR-Z2	
3	ST202MTR-Z3			3	ST204MTR-Z3	
4	ST202MTR-Z4			4	ST204MTR-Z4	
5	ST202MTR-Z5			5	ST204MTR-Z5	
6	ST202MTR-Z6			6	ST204MTR-Z6	
8	ST202MTR-Z8			8	ST204MTR-Z8	
10	ST202MTR-Z10			10	ST204MTR-Z10	
15	ST202MTR-Z15			15	ST204MTR-Z15	
16	ST202MTR-Z16			16	ST204MTR-Z16	
20	ST202MTR-Z20			20	ST204MTR-Z20	
25	ST202MTR-Z25			25	ST204MTR-Z25	
30	ST202MTR-Z30			30	ST204MTR-Z30	
32	ST202MTR-Z32	32	ST204MTR-Z32			
35	ST202MTR-Z35	35	ST204MTR-Z35			
40	ST202MTR-Z40	40	ST204MTR-Z40			
50	ST202MTR-Z50	50	ST204MTR-Z50			
60	ST202MTR-Z60	60	ST204MTR-Z60			
63	ST202MTR-Z63	63	ST204MTR-Z63			

ABB Products Proudly Distributed by Gross Automation.

Please call +1 (262) 252-1600 or email [sales@grossautomation.com](mailto:sales@grossautomation.com).

## ST200MTR — ring tongue terminal

Z characteristic — DC



	Number of poles	Rated current		Cat. no.	Number of poles	Rated current	
		$I_n$ A				$I_n$ A	Cat. no.
	1	0.5		ST201MTR-Z0,5 DC	4	0.5	ST204MTR-Z0,5 DC
		1		ST201MTR-Z1 DC		1	ST204MTR-Z1 DC
		1.6		ST201MTR-Z1,6 DC		1.6	ST204MTR-Z1,6 DC
		2		ST201MTR-Z2 DC		2	ST204MTR-Z2 DC
		3		ST201MTR-Z3 DC		3	ST204MTR-Z3 DC
		4		ST201MTR-Z4 DC		4	ST204MTR-Z4 DC
		5		ST201MTR-Z5 DC		5	ST204MTR-Z5 DC
		6		ST201MTR-Z6 DC		6	ST204MTR-Z6 DC
		8		ST201MTR-Z8 DC		8	ST204MTR-Z8 DC
		10		ST201MTR-Z10 DC		10	ST204MTR-Z10 DC
		15		ST201MTR-Z15 DC		15	ST204MTR-Z15 DC
		16		ST201MTR-Z16 DC		16	ST204MTR-Z16 DC
		20		ST201MTR-Z20 DC		20	ST204MTR-Z20 DC
		25		ST201MTR-Z25 DC		25	ST204MTR-Z25 DC
		30		ST201MTR-Z30 DC		30	ST204MTR-Z30 DC
		32		ST201MTR-Z32 DC		32	ST204MTR-Z32 DC
		35		ST201MTR-Z35 DC		35	ST204MTR-Z35 DC
			2	0.5			ST202MTR-Z0,5 DC
1				ST202MTR-Z1 DC	1	ST204MTR-Z1 DC	
1.6				ST202MTR-Z1,6 DC	1.6	ST204MTR-Z1,6 DC	
2				ST202MTR-Z2 DC	2	ST204MTR-Z2 DC	
3				ST202MTR-Z3 DC	3	ST204MTR-Z3 DC	
4				ST202MTR-Z4 DC	4	ST204MTR-Z4 DC	
5				ST202MTR-Z5 DC	5	ST204MTR-Z5 DC	
6				ST202MTR-Z6 DC	6	ST204MTR-Z6 DC	
8				ST202MTR-Z8 DC	8	ST204MTR-Z8 DC	
10				ST202MTR-Z10 DC	10	ST204MTR-Z10 DC	
15				ST202MTR-Z15 DC	15	ST204MTR-Z15 DC	
16				ST202MTR-Z16 DC	16	ST204MTR-Z16 DC	
20				ST202MTR-Z20 DC	20	ST204MTR-Z20 DC	
25				ST202MTR-Z25 DC	25	ST204MTR-Z25 DC	
30				ST202MTR-Z30 DC	30	ST204MTR-Z30 DC	
32				ST202MTR-Z32 DC	32	ST204MTR-Z32 DC	
35				ST202MTR-Z35 DC	35	ST204MTR-Z35 DC	
	4			0.5		ST204MTR-Z0,5 DC	4
		1		ST204MTR-Z1 DC	1	ST204MTR-Z1 DC	
		1.6		ST204MTR-Z1,6 DC	1.6	ST204MTR-Z1,6 DC	
		2		ST204MTR-Z2 DC	2	ST204MTR-Z2 DC	
		3		ST204MTR-Z3 DC	3	ST204MTR-Z3 DC	
		4		ST204MTR-Z4 DC	4	ST204MTR-Z4 DC	
		5		ST204MTR-Z5 DC	5	ST204MTR-Z5 DC	
		6		ST204MTR-Z6 DC	6	ST204MTR-Z6 DC	
		8		ST204MTR-Z8 DC	8	ST204MTR-Z8 DC	
		10		ST204MTR-Z10 DC	10	ST204MTR-Z10 DC	
		15		ST204MTR-Z15 DC	15	ST204MTR-Z15 DC	
		16		ST204MTR-Z16 DC	16	ST204MTR-Z16 DC	
		20		ST204MTR-Z20 DC	20	ST204MTR-Z20 DC	
		25		ST204MTR-Z25 DC	25	ST204MTR-Z25 DC	
		30		ST204MTR-Z30 DC	30	ST204MTR-Z30 DC	
		32		ST204MTR-Z32 DC	32	ST204MTR-Z32 DC	
		35		ST204MTR-Z35 DC	35	ST204MTR-Z35 DC	

ABB Products Proudly Distributed by Gross Automation.

Please call +1 (262) 252-1600 or email [sales@grossautomation.com](mailto:sales@grossautomation.com).

## Accessories

ST200M, S200MR, S200MUC and S300P — UL 1077, CSA 22.2 No. 235

### Auxiliary contacts

The auxiliary contacts will signal whether the breaker is in the ON or OFF position.

	Description	Cat. no.
<b>For field mounting: right side</b>		
	Auxiliary contact 1 CO	S2C-H6R
	Auxiliary contact 1 NO/1 NC	S2C-H6-11R
	Auxiliary contact 2 NO	S2C-H6-20R
	Auxiliary contact 2 NC	S2C-H6-02R

### Bell alarm — signal contact

The bell alarm includes a set of contacts that will only signal when the breaker has tripped. Typically, the contacts would be connected to an alarm or bell to signal the operator that an over-current trip has occurred. The bell alarm also includes a test button for testing the alarm contacts without opening the breaker.



	Description	Cat. no.
	For field mounting: right side	S2C-S/H6R

### Shunt trip

For remote tripping of breaker, a shunt trip device can be added to the MCB. The solenoid device opens the breaker after control voltage is applied.

	Description	Cat. no.
<b>For field mounting: right side</b>		
	A1-12-60 V AC (12–60 V DC)	S2C-A1
	A2-110-415 V AC (110–250 V DC)	S2C-A2

### Locking device

	Description	Cat. no.
	Locking device, 3 mm	SA1
	Padlock with two keys	SA2

### Bottom-fitted auxiliary contact

	Description	Cat. no.
	Auxiliary contact 1 NC	S2C-H01
	Auxiliary contact 1 NO	S2C-H10

## Accessories

ST200M, S200MR, S200MUC and S300P — UL 1077, CSA 22.2 No. 235

### Accessory overview

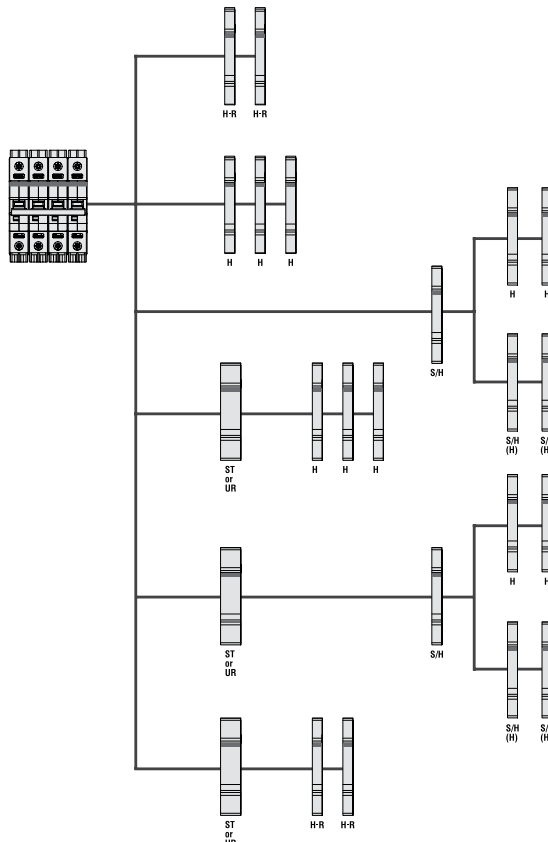

- H Auxiliary contact S2C-H6R
- H-R Auxiliary contact S2C-H6-...R
- S/H Signal/auxiliary contact S2C-S/H6R
- S/H (H) Signal/auxiliary contact S2C-S/H6R used as auxiliary contact
- ST Shunt trip S2C-A...
- UR Under-voltage release S2C-UA

### SU200MR Instructions for use

**Ring Tongue Terminal, Special purpose - Not for general use**

**Installation Instructions**

Please insert or withdraw the cable lug only when the screw is completely open.

Please make sure that the terminal screw penetrates the ring lug hole properly and completely during tightening.

Please ensure that the screw is securely tightened before applying any mechanical force on the cable / cable lug.

Do not apply abnormal downward pressure on the screw during tightening or loosening of the screw.

F = max. 30 N      F = Maximum to operate

Please follow the Ring Tongue Details on the rear of this sheet.

**Ring Tongue Details**

Only  or  ring cable lugs	Rated voltage 480Y/277 V AC	Insulated only 	A max. 11.0 mm (0.43")	B max. 12.2 mm (0.48")	C Suitable for M5 (0.20")
	Rated voltage 240/240 V AC	Insulated only 	A max. 14.0 mm (0.55")	B max. 12.2 mm (0.48")	C Suitable for M5 (0.20")

CU only  
 60/75°C  
 (140/167°F)

max. 2.0 mm  
 (0.08")

PZ 2 Torque: 2.8 Nm (25lb-in)

## Busbars PS...CB and accessories according to UL 508

For MCBs ST200M, S200MUC and S300P



Busbars type PS...CB are used for quick and easy line side wiring of miniature circuit breakers according to UL 1077 as well as fuse disconnectors E90. The entire product line, including the accessories, is approved according to UL 508 (cULus) and can be used for applications in supplementary protection circuits in UL and CSA markets

### Application and installation

- cULus listing according to UL 508
- For UL and CSA applications
- For use with MCB types according UL 1077, ranges S200, S200M, S200P, S200MUC, S200MTUC, ST200M and fuse disconnectors E90
- Quick and easy installation
- Can be cut off to the required length
- Suitable for AC and DC applications
- Global use in UL, CSA and IEC markets
- 

### Product range

- 1-, 2-, 3-pole types
- 18 mm<sup>2</sup> and 25 mm<sup>2</sup> cross section
- For MCBs with or without auxiliary contact
- Touch-safe thanks to end caps and electric shock-protection caps installed over unused busbar pins
- Rated current max. 200 A
- Rated voltage according to UL
  - 1-phase: 1,000 V AC/DC
  - 2-/3-phase: 600 V AC/DC
- End caps, electric shock-protection caps and feeder terminals as accessories

**ABB Products Proudly Distributed by Gross Automation.**

**Please call +1 (262) 252-1600 or email [sales@grossautomation.com](mailto:sales@grossautomation.com).**

## Busbars PS...CB and accessories according to UL 508

### Technical data

#### Technical data

		<b>Busbars PS...CB</b>	
Standards		UL 508 IEC EN 60947-1	
<b>Electrical data</b>	Rated voltage $U_e$	V	<b>1-phase</b> 1,000 V AC/DC
	Current carrying capacity / phase (35 °C ambient temperature)	A	<b>2- / 3-phase</b> UL: 600 V AC/DC IEC: 690 V AC/DC
			<b>18 mm<sup>2</sup></b> <b>25 mm<sup>2</sup></b>
Short-circuit rating	kA	10 kA 3 cycles @ 480 V / 100 kA fuse class J 175 A / 18 mm <sup>2</sup> - 200 A / 25 mm <sup>2</sup>	
<b>Mechanical Data</b>	Housing	Light gray, RAL 7035	
	Overvoltage category	III	
	Pollution degree	2	
<b>Installation</b>	Busbar cross section	mm <sup>2</sup>	18 mm <sup>2</sup> / 25 mm <sup>2</sup>
	Mounting position	Optional	
	Supply	Feed to the device's terminal (supply side optional) or use feeder terminal AST 35/15-1 CB; AST 35/15-2 CB; AST 35/38-1 CB; AST 35/38-2 CB; SZ-ESK SP	
<b>Accessories</b>	Electric shock-protection caps	BSK CB	
	Feeder terminals	AST 35/15-1 CB; AST 35/15-2 CB AST 35/38-1 CB; AST 35/38-2 CB SZ-ESK SP	
	End caps	PS-END 1 CB PS-END 3 CB	
<b>Approvals</b>			UL 508: cULus listed
			CE and RoHS compliant
			In addition to the approval of the busbar, the approval of the switching device used must also be considered.
<b>Installation instructions</b>	When cutting the busbar, ensure that the insulation profile protrudes beyond the end of the copper bar by approx. 10 mm at each end. Electric shock-protection only ensured with end caps mounted.		

<sup>1)</sup> Irrespective of the current carrying capacity of the busbar, the max. rated current of the devices terminal must not be exceeded.

## Busbars PS...CB and accessories according to UL 508

### Ordering data

#### Busbars suitable for cutting

Phases	mm <sup>2</sup>	No. of pins	Weight 1 piece kg	Pack unit pc.	Cat. no.
<b>1-phase busbars, pin distance 17.6mm, end caps PS-END 1 CB</b>					
1	18	57	0.289	10	PS1/57/18CB
1	25	57	0.360	10	PS1/57/25CB
<b>1-phase busbars, connection of 1-pole devices with auxiliary, end caps PS-END 1 CB</b>					
1	18	37	0.254	10	PS1/37/18HCB
1	25	37	0.310	10	PS1/37/25HCB
<b>2-phase busbars, pin distance 17.6mm, end caps PS-END 3 CB</b>					
2	18	56	0.639	10	PS2/56/18CB
2	25	56	0.795	10	PS2/56/25CB
<b>2-phase busbars, connection of 2-pole devices with auxiliary, end caps PS-END 3 CB</b>					
2	18	46	0.672	10	PS2/46/18HCB
2	25	46	0.782	10	PS2/46/25HCB
<b>3-phase busbars, pin distance 17.6mm, end caps PS-END 3</b>					
3	18	57	0.929	10	PS3/57/18CB
3	25	57	1.026	10	PS3/57/25CB
<b>3-phase busbars, connection of 3-pole devices with auxiliary, end caps PS-END 3 CB</b>					
3	18	48	0.788	10	PS3/48/18HCB
3	25	48	0.974	10	PS3/48/25HCB
<b>3-phase busbars, connection of 1-pole devices with auxiliary, end caps PS-END 3 CB</b>					
3	18	39	0.794	10	PS3/39/18HCB
3	25	39	0.974	10	PS3/39/25HCB

#### Accessories

	Weight 1 piece kg	Pack unit pc.	Cat. no.
<b>Electric shock-protection cap</b>			
	0.008	10	BSK CB
<b>Feeder terminals with pin contact</b>			
for use with MCB and 1-phase busbar	0.025	25	AST35/15-2CB
for use with MCB and 2-/3-phase busbar	0.032	10	AST35/38-2CB
for use with E90 and 2-/3-phase busbar	0.032	10	AST35/38-1CB
for use with E90 and 1-phase busbar	0.025	25	AST35/15-1CB
<b>Single-pole terminal, can be mounted side by side, feed to the busbar pin</b>			
	0.032	50	SZ ESK SP
<b>End caps</b>			
for use with PS 1...CB	0.001	50	PS-END 1 CB
for use with PS 2...CB and PS3...CB	0.002	50	PS-END 3 CB

## Busbars PS...CB and accessories according to UL 508

### Technical data feeder terminals

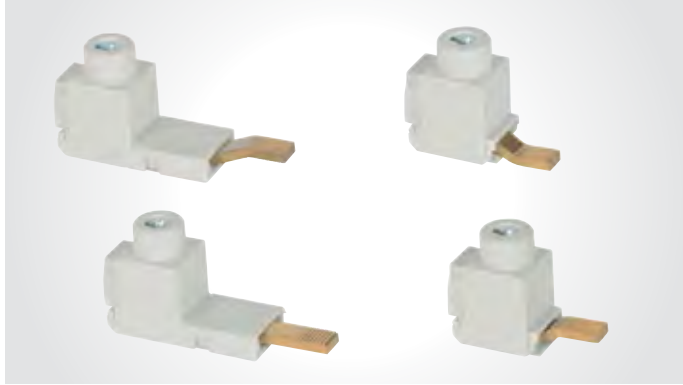

Feeder terminals AST..CB to connect copper wires up to a cross section of 50 mm<sup>2</sup> to DIN rail devices in pro M compact® system.

The terminals are cULus listed according to UL 508 and can be used for applications in supplementary protection circuits in combination with UL/CSA approved miniature circuit breakers and E90 fuse disconnectors.

#### Technical data

		Feeder terminal AST..CB
Electrical data	Standards	UL 508 / UL 486A / CSA C22.2 / IEC 60999
	Rated voltage U <sub>e</sub>	UL: 1,000 V AC/DC IEC: 1,000 V AC / 1,500 V DC
	Rated current I <sub>e</sub>	UL: 115 A IEC: 160 A
Mechanical data	Housing	PA66, gray RAL 7035
	Chassis	Brass
	Terminal screw	Steel, zinc-plated
	Protection degree	IP 20
Installation	Cross section	Solid / stranded: 6..50 mm <sup>2</sup> ; 10 AWG..1/0 AWG Flexible with ferrules: 6..35 mm <sup>2</sup> ; 10 AWG..2 AWG
	Tightening torque	6 mm <sup>2</sup> / 10 AWG: 4.0 Nm / 35 lbf-in 8 mm <sup>2</sup> / 8 AWG: 4.5 Nm / 40 lbf-in 10..16 mm <sup>2</sup> / 6..4 AWG: 5.1 Nm / 45 lbf-in 25..50 mm <sup>2</sup> / 3..1/0 AWG: 5.5 Nm / 50 lbf-in*
	Stripping length	* Tightening torque according to UL486A, Table 21, Clauses 9.1.9.4 and 9.1.9.6 ~ 14 mm; 9/16"
	Conductor material	Copper
Approvals	UL 508 CE, RoHS and REACH compliant In addition to the approval of the feeder terminal, the approval of the switching device used must also be considered.	
Instruction of installation	The feeder terminals are single-phase. In case of a combination of multiple terminals with installation side by side, e.g. for multipole or DC applications, the required creepage and air leakage distances must be considered and observed. To ensure protection against electrical electric shock, the pin length of the feeder terminal must not exceed the depth of the contact area of the connected device. Irrespective of the current carrying capacity of the feeder terminal, the max. rated current of the devices terminal must not be exceeded.	

#### Order codes

Feeder terminals with pin contact	Weight	Pack	Cat. no.
	1 piece	unit	
	kg	pc.	
for use with MCB and 1-phase busbar	0.025	25	AST35/15-2CB
for use with MCB and 2-/3-phase busbar	0.032	10	AST35/38-2CB
for use with E90 and 2-/3-phase busbar	0.032	10	AST35/38-1CB
for use with E90 and 1-phase busbar	0.025	25	AST35/15-1CB

## Busbars PS...CB and accessories according to UL 508

Installation of busbars and use of feeder terminals/cables for feed

### Installation of busbars and use of feeder terminals/cables for feed

**MCB with 1-phase busbar**  
Feeder terminal AST 35/15-2 CB

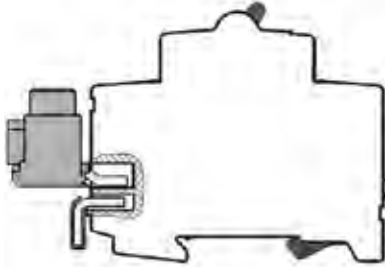

**MCB with 1-phase busbar**  
Feed using cable

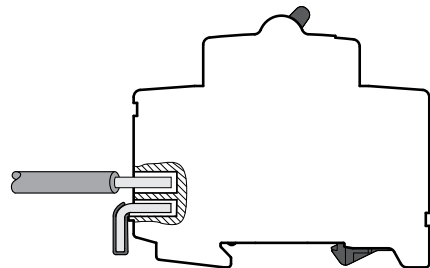

**E90 with 1-phase busbar**  
Feeder terminal AST 35/15-1 CB

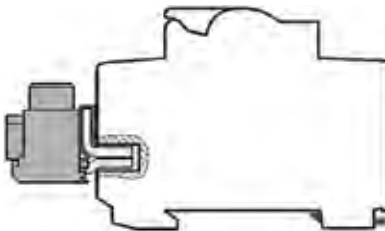

**E90 with 1-phase busbar**  
Feed using cable

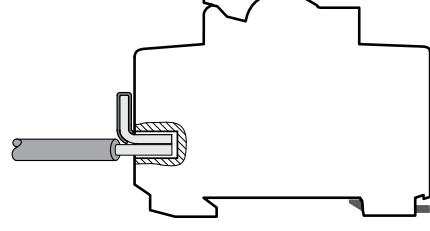

**E90 with 2-/3-phase busbar**  
Feeder terminal AST 35/38-1 CB

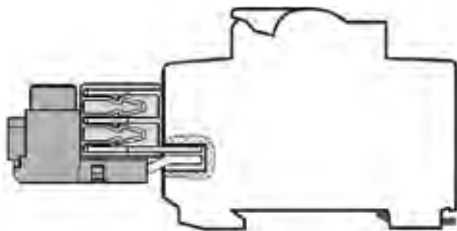

**E90 with 2-/3-phase busbar**  
Feed using cable

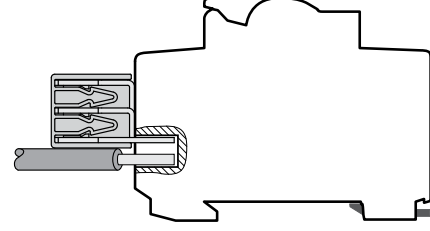

**MCB with 2-/3-phase busbar**  
Feeder terminal AST 35/38-2 CB

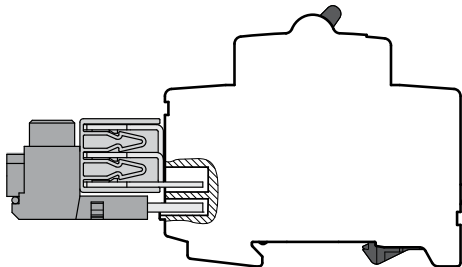

**MCB with 2-/3-phase busbar**  
Feed using cable

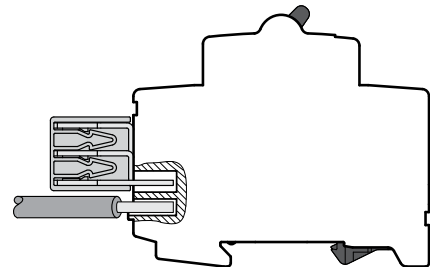

## Busbars PS...CB and accessories according to UL 508

### Overall dimensions

#### 1-phase busbars

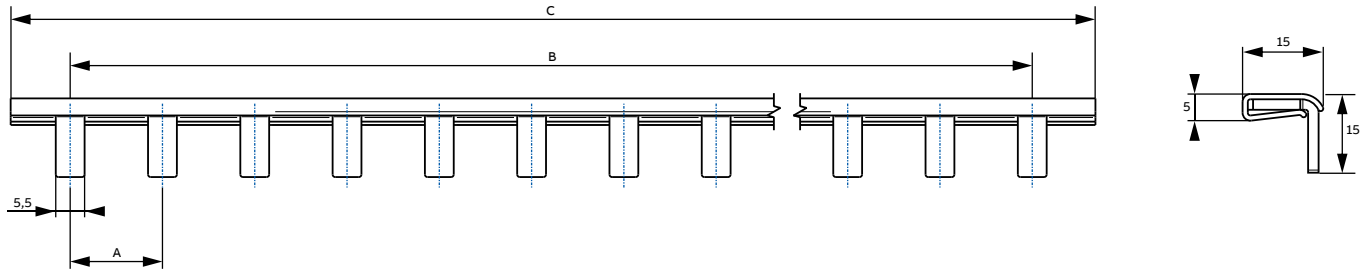

#### 2-/3-phase busbars

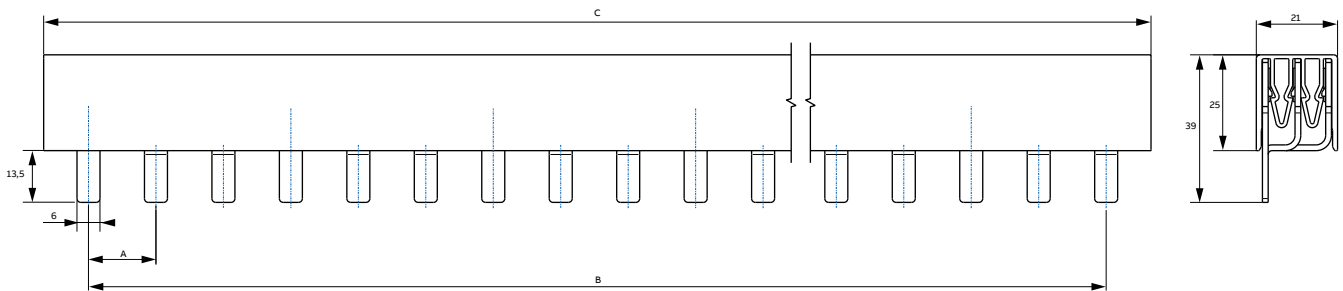

#### Overall dimensions

Busbar	A mm	B mm	C mm
<b>1-phase busbars</b>			
PS1/57/18CB	17.6	986	1010
PS1/57/25CB	17.6	986	1010
PS1/37/18HCB	26.4	950	985
PS1/37/25HCB	26.4	950	985
<b>2-phase busbars</b>			
PS2/56/18CB	17.6	968	990
PS2/56/25CB	17.6	968	990
PS2/46/18HCB	17.6 / 26.4 *	968	1010
PS2/46/25HCB	17.6 / 26.4 *	968	990
<b>3-phase busbars</b>			
PS3/57/18CB	17.6	986	1010
PS3/57/25CB	17.6	986	1010
PS3/48/18HCB	17.6 / 26.4 *	924	982
PS3/48/25HCB	17.6 / 26.4 *	924	982
PS3/39/18HCB	26.4	1003	1040
PS3/39/25HCB	26.4	1003	1040

\* pin gap for auxiliary

---

## Accessories

S800S, S800C, S800P

See pages 27–29.

## Technical specifications

ST200M, S200MR, S200MUC — UL 1077, CSA 22.2 No. 235

### Technical specifications

	ST200M	S200MR	S200MUC
Number of poles	1, 2, 3, 4	1, 2, 3, 4	1, 2, 3, 4
Trip curves	B, C, D, K, Z	K	C, K, Z
Rated current	0.5–63 A	0.2–63 A	0.2–63 A
Rated voltage	277/Y480 V AC 60/125 V DC (1/2-pole)	277/Y480 V AC	277/Y480 V AC 250/500 V DC (1/2-pole)
Short circuit interrupt rating	10 kA at 480Y/277 V AC (up to 32 A) 5 kA at 480Y/277 V AC (35 to 63 A) 10 kA at 240 V AC, 60/125 V DC	10 kA	10 kA (DC) 6 kA (AC)
Calibration temperature	40 °C	25 °C	25 °C
Protection degree	IP20	IP20	IP20
Mounting position	Any	Any	Any
Mounting/installation	35 mm DIN rail	35 mm DIN rail	35 mm DIN rail
Terminal/cable size	18–4 AWG	18–4 AWG	18–4 AWG
Service life, mechanical	20,000 operations	20,000 operations	20,000 operations
Ambient temperature	-40 °C to 70 °C	-40 °C to 70 °C	-40 °C to 70 °C
Shock resistance (IEC 60068-2-27)	25 g - 2 shocks - 13 ms	25 g - 2 shocks - 13 ms	25 g - 2 shocks - 13 ms

NOTE: For the ambient temperature -40 °C up to +70 °C, average over a period of 24 hours shall not exceed +55 °C.

### Auxiliary contact S2C-H6R and signal contact S2C-S6R

Rated current (A)	10
Rated voltage V AC/DC	24
Contact	1 pole, single throw
Connection capacity	18–14 AWG (0.75–2.5 mm <sup>2</sup> )
Tightening torque	11 in. lbs (1.2 Nm)
Shock resistance acc. to DIN IEC 68-2-6	5 g, 20 frequency cycles 5...150...5 Hz at 24 V AC/DC, 5 mA auto-reclosing < 10 ms
Mechanical service life	10,000 operations

## Technical specifications

ST200M, S200MR, S200MUC — UL 1077, CSA 22.2 No. 235

### Shunt trip

	S2C-A1	S2C-A2
Rated voltage	12–60 V AC	110–415 V
	12–60 V DC	110–250 V
Maximum release duration	<10 ms	<10 ms
Minimum release voltage	7 V AC	55 V AC
	10 V DC	80 V DC
Consumption on release	40–200 VA AC	55–210 VA AC
	40–200 VA DC	55–110 VA DC
Coil resistance	3.7 V	225 V
Terminals	18–6 AWG/0.75–16 mm <sup>2</sup>	18–6 AWG/0.75–16 mm <sup>2</sup>
Tightening torque	18/2 in. lbs/Nm	18/2 in. lbs/Nm

### Under-voltage release

	S2C-UA 12 DC	S2C-UA 24 AC	S2C-UA 24 DC	S2C-UA 48 AC	S2C-UA 48 DC	S2C-UA 110 AC	S2C-UA 110 DC	S2C-UA 230 AC	S2C-UA 230 DC	S2C-UA 400 AC
Standards	IEC/EN 60947-1110...415 V									
Rated voltage	AC	24 V		48 V		110 V		230 AC		400 V
	DC	12 V	24 V		48 V		110 V		230 V	
Frequency	50 ... 60 HZ									
Release trip	0.35 UnOVO 0.7 Un V									
Terminals	2 x 16 AWG/2 x 1.5 mm <sup>2</sup>									
Consumption	0.2 VA	3.6 VA	2 VA	3.6 VA	2.1 VA	3.5 VA	2.2 VA	3.7 VA	2.3 VA	2.4 VA
Resistance to corrosion	Constant atmosphere: 23/83 – 40/93 – 55/20; variable atmosphere: 25/95 – 40/93 °C/RH									
Protection degree	IPXXB / IP2X									
Tightening torque	3.5 lbs./0.4 in. Nm									

## Technical specifications

ST200M and S200MR — UL 1077, CSA 22.2 No. 235

### Internal resistance and power loss per pole

Internal resistance per pole in mV, power loss per pole in W.

#### ST200M internal resistance and power loss per pole

Rated current $I_n$ [A]	B. C. K		D		Z	
	Internal resistance per pole $R_i$ [mOhm]	Power loss $P_v$ [W]	Internal resistance per pole $R_i$	Power loss $P_v$	Internal resistance per pole $R_i$	Power loss $P_v$
0.5	5500	1.4	4300	1.1	8100	2.4
1	1440	1.4	1250	1.25	2100	2.3
1.6	645	1.8	600	1.5	1000	2.8
2	460	1.8	410	1.7	620	2.5
3	150	1.6	130	1.2	235	2.4
4	110	1.8	105	1.7	150	2.4
5	55	1.4	52	1.3	75	1.9
6	55	2.0	52	1.9	75	3.2
7	24	1.2	26	1.3	28	1.4
8	23	1.5	24	1.5	27	2.0
10	21	2.2	16	1.6	24	2.7
13	14	2.3	14	2.2	15	2.6
15	8.5	2	8.5	2	11	2.5
16	8.5	2.5	8.5	2.5	10.9	2.8
20	6.25	2.5	6.1	2.3	6.0	2.4
25	5.0	3.2	4.3	3.1	4.5	3.3
30	3.5	3.1	3.5	3.2	3.5	3.2
32	3.5	3.7	3.5	3.6	3.5	3.6
35	3.4	4.2	3.4	4.2	3.5	4.3
40	3.0	4.8	2.2	4.2	2.5	4.1
50	1.8	4.3	1.3	2.9	1.5	4.1
60	1.2	4.4	1.2	4.4	1.3	4.7
63	1.2	5.5	1.2	4.8	1.3	5.2

#### S200MR internal resistance and power loss per pole

Rated current A	Internal resistance per pole mΩ	Power loss per pole W	Rated current A	Internal resistance per pole mΩ	Power loss per pole W
0.2	25300	1.01	13	14.8	2.50
0.3	13700	1.23	15	8.1	1.83
0.5	4740	1.19	16	11.1	2.83
0.75	2067	1.16	20	8.5	3.40
1	1270	1.27	25	5.5	3.43
1.5	610	1.56	30	3.8	3.39
2	442	1.77	32	4.6	4.70
3	140	1.26	35	3.9	4.76
4	109	1.75	40	2.8	4.40
5	50	1.26	50	1.7	4.25
6	54	1.94	60	1.7	6.18
8	22	1.41	63	1.9	7.56
10	18.2	1.82			

ABB Products Proudly Distributed by Gross Automation.

Please call +1 (262) 252-1600 or email [sales@grossautomation.com](mailto:sales@grossautomation.com).

## Technical specifications

ST200M and S200MR — UL 1077, CSA 22.2 No. 235

### ST200M temperature rating

### Temperature derating

Max. operating current depending on the ambient temperature.

UL 1077		Ambient temperature (°C)										
$I_n$ (A)	-40	-30	-20	-10	0	10	20	30	40	50	60	70
0.5	0.65	0.63	0.61	0.59	0.57	0.56	0.54	0.52	0.50	0.48	0.46	0.44
1	1.30	1.26	1.22	1.19	1.15	1.11	1.07	1.04	1.00	0.96	0.93	0.89
1.6	2.06	2.01	1.96	1.90	1.84	1.78	1.72	1.66	1.60	1.54	1.48	1.42
2	2.60	2.52	2.44	2.37	2.30	2.22	2.15	2.07	2.00	1.93	1.85	1.78
3	3.89	3.78	3.67	3.56	3.44	3.33	3.22	3.11	3.00	2.89	2.78	2.67
4	5.19	5.04	4.89	4.74	4.59	4.44	4.30	4.15	4.00	3.85	3.70	3.56
5	6.50	6.31	6.13	5.94	5.75	5.56	5.38	5.00	5.00	4.81	4.63	4.44
6	7.77	7.55	7.33	7.11	6.89	6.67	6.44	6.22	6.00	5.78	5.56	5.33
7	9.10	8.84	8.58	8.31	8.05	7.79	7.53	7.00	7.00	6.74	6.48	6.21
8	10.36	10.07	9.78	9.48	9.18	8.89	8.59	8.30	8.00	7.70	7.41	7.11
10	13.00	12.60	12.20	11.90	11.50	11.10	10.70	10.40	10.00	9.60	9.30	8.90
13	16.90	16.40	15.90	15.40	14.90	14.40	14.00	13.50	13.00	12.50	12.00	11.60
15	19.50	18.94	18.38	17.81	17.25	16.69	16.13	16.00	15.00	14.44	13.88	13.31
16	20.60	20.10	19.60	19.00	18.40	17.80	17.20	16.60	16.00	15.40	14.80	14.20
20	26.00	25.20	24.40	23.70	23.00	22.20	21.50	20.70	20.00	19.30	18.50	17.80
25	32.40	31.50	30.60	29.60	28.70	27.80	26.90	25.90	25.00	24.10	23.20	22.20
30	39.00	37.88	36.75	35.63	34.50	33.38	32.25	31.00	30.00	28.88	27.75	26.63
32	41.50	40.30	39.10	37.90	36.70	35.60	34.40	33.20	32.00	30.80	29.60	28.40
35	47.00	45.30	43.70	42.10	40.60	39.10	37.70	36.30	35.00	33.70	32.50	31.30
40	51.90	50.40	48.90	47.40	45.90	44.40	43.00	41.50	40.00	38.50	37.00	35.60
50	64.90	63.00	61.10	59.30	57.40	55.60	53.70	51.90	50.00	48.20	46.30	44.50
60	80.50	77.60	74.80	72.10	69.50	67.00	64.60	62.30	60.00	57.80	55.70	53.70
63	81.60	79.30	77.00	74.70	72.30	70.00	67.70	65.30	63.00	60.70	58.30	56.00

### S200MR temperature rating

B, C, D, K, and Z	Ambient temperatures T (C °/F °)											
	-40/-40	-30/-22	-20/-4	-10/14	0/32	10/50	20/68	30/86	40/104	50/122	60/140	70/158
Amps	0.67	0.65	0.62	0.60	0.58	0.55	0.53	0.50	0.47	0.44	0.41	0.37
	1.33	1.29	1.25	1.20	1.15	1.11	1.05	1.00	0.94	0.88	0.82	0.75
	2.13	2.07	2.00	1.92	1.85	1.77	1.69	1.60	1.51	1.41	1.31	1.19
	2.67	2.58	2.49	2.40	2.31	2.21	2.11	2.00	1.89	1.76	1.63	1.49
	4.0	3.9	3.7	3.6	3.5	3.3	3.2	3.0	2.8	2.6	2.4	2.2
	5.3	5.2	5.0	4.8	4.6	4.4	4.2	4.0	3.8	3.5	3.3	3.0
	8.0	7.7	7.5	7.2	6.9	6.6	6.3	6.0	5.7	5.3	4.9	4.5
	10.7	10.3	10.0	9.6	9.2	8.8	8.4	8.0	7.5	7.1	6.5	6.0
	13.3	12.9	12.5	12.0	11.5	11.1	10.5	10.0	9.4	8.8	8.2	7.5
	17.3	16.8	16.2	15.6	15.0	14.4	13.7	13.0	12.3	11.5	10.6	9.7
	21.3	20.7	20.0	19.2	18.5	17.7	16.9	16.0	15.1	14.1	13.1	11.9
	26.7	25.8	24.9	24.0	23.1	22.1	21.1	20.0	18.9	17.6	16.3	14.9
	33.3	32.3	31.2	30.0	28.9	27.6	26.4	25.0	23.6	22.0	20.4	18.6
	42.7	41.3	39.9	38.5	37.0	35.4	33.7	32.0	30.2	28.2	26.1	23.9
	53.3	51.6	49.9	48.1	46.2	44.2	42.2	40.0	37.7	35.3	32.7	29.8
	66.7	64.5	62.4	60.1	57.7	55.3	52.7	50.0	47.1	44.1	40.8	37.3
	84.0	81.3	78.6	75.7	72.7	69.6	66.4	63.0	59.4	55.6	51.4	47.0
	112.6	107.2	102.1	97.2	92.6	88.2	84.0	80.0	76.0	72.2	68.6	65.2
	140.7	134.0	127.6	121.6	115.8	110.3	105.0	100.0	95.0	90.3	85.7	81.5
	175.9	167.5	159.5	151.9	114.7	137.8	131.3	125.0	118.8	113.8	107.2	101.8

**ABB Products Proudly Distributed by Gross Automation.**

**Please call +1 (262) 252-1600 or email [sales@grossautomation.com](mailto:sales@grossautomation.com).**

## Miniature circuit breaker S200MUC

### Use of MCBs in direct current circuits

S200MUC miniature circuit breakers can be used in the 1-pole version at 250 V DC, and in the 2-pole or 4-pole version with series connection of two poles up to 500 V DC.

S200MUC differs from the standard S200 type. It is equipped with permanent magnets that assist in the forced extinguishing of the arc.

If voltages to ground exceeding 250 V DC occur, 2-pole S200MUC should be used for 1-pole disconnection and 4-pole S200MUC for all-pole disconnection.

#### For DC incoming supply from above

S200MUC MCBs have permanent magnets in the area of arc chutes. Therefore, it is necessary to take into account the polarity during the installation process. In the case of a short circuit, the magnetic field of the permanent magnets corresponds with the electromagnetic field of the short-circuit current, therefore, safely leading the short circuit into the arc chute. Incorrect polarities may cause damage to the MCB. As a result, for top-fed devices, terminal 1 must be connected to (-) and terminal 3 to (+).

#### Examples of permissible voltages between the conductors depending on the number of poles and circuit layout:

Voltage between conductors	$U_n$	250 V DC	500 V DC	500 V DC	500 V DC	500 V DC
Voltage between conductor and ground $U_n$		250 V DC	250 V DC	500 V DC	250 V DC	250 V DC
MCB		1-pole S201MUC	2-pole S202MUC	2-pole S202MUC	2-pole S202MUC	4-pole S204MUC

Supply from below

SK 0115 Z 94

Supply from above

SK 0114 Z 94

1 In the circuit diagram, the negative pole is earthed. 2 In the circuit diagram, the positive pole is earthed.

#### Examples of permissible voltages between the conductors depending on the number of poles and circuit layout:

Voltage between conductors	$U_n$	500 V DC all-pole disconnection	500 V DC 1-pole disconnection	500 V DC all-pole disconnection
Voltage between conductor and ground $U_n$		250 V DC circuit symmetrically grounded	250 V DC unsymmetrically grounded	250 V DC circuit ungrounded or unsymmetrically grounded
MCB		2-pole S202MUC	2-pole S202MUC	4-pole S204MUC

Supply from below

SK 0196 Z 98

1 In the circuit diagram, the negative pole is earthed. 2 In the circuit diagram, the positive pole is earthed.

**Approximate dimensions**

ST200M, S200MR, S200MUC and S300P — UL 1077, CSA 22.2 No. 235

**ST200M, S200MUC, S300P**

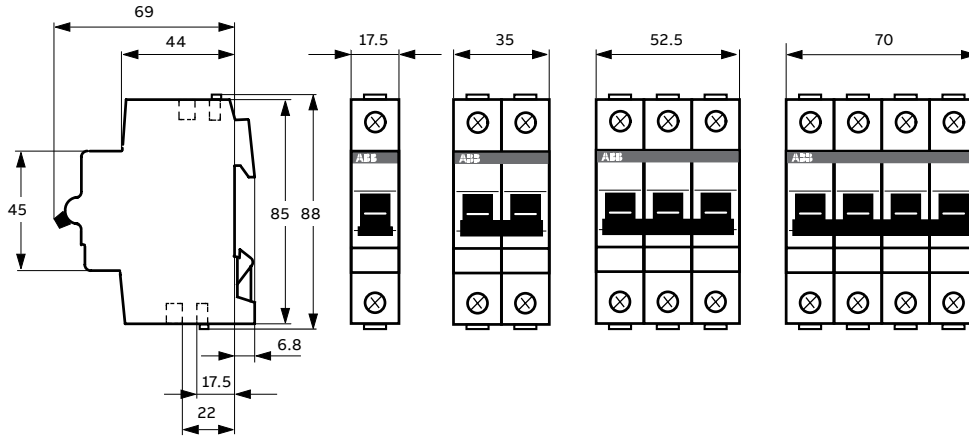

**S200MR**

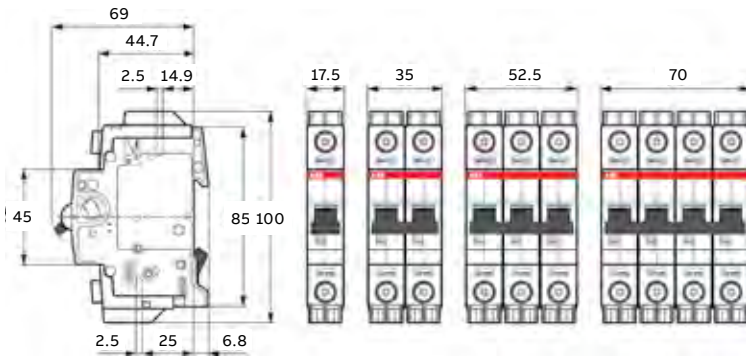

**ST200MTR**

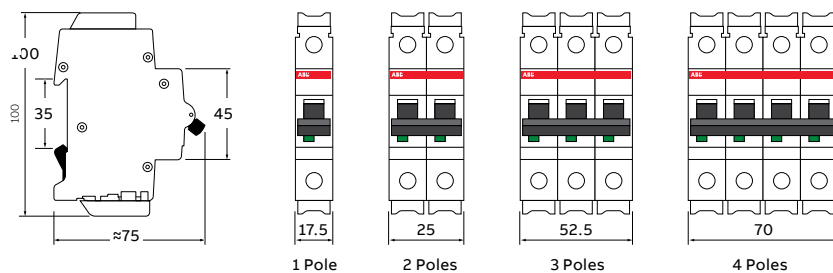

## Technical data

### S800C

<b>General data</b>	
Tripping characteristic	B, C, D, K
Standard	IEC 60947-2, EN 60898-1, UL 1077
Poles	1–4
Rated frequency	50/60 Hz
<b>Data acc. to UL1077</b>	
Rated voltage U	240 V AC (1p, 3p) 277/480Y V AC (1p, 3p) 125 V DC (1p) 250 V DC (2p) 375 V DC (3p) 500 V DC (4p)
Rated current I	10–100 A
Short-circuit breaking capacity $I_{cc}$	20 kA (240 V AC) 10 kA (277/480Y V AC) 10 kA (500 V DC)
Rated insulation voltage $U_i$	500 V AC
Reference temperature for tripping characteristic	B, C, D: 30 °C, K: 40 °C
<b>General data</b>	
Electrical and mechanical endurance	Up to 100 A: 6000 electrical/4000 mechanical
<b>Installation</b>	
Terminal	Failsafe cage terminal
Connection (top/bottom) – Cu only	14–2 AWG (10–30 A, solid or stranded) 1–8 AWG (40–100 A, stranded) Single conductor per terminal, 60/75 °C wire (10–30 A), 60 °C wire (40–100 A)
Tightening torque	3.5 Nm/31 in. lb.
Mounting position	Any
Supply side	Any

## Technical data

### S800S

<b>General data</b>	
Tripping characteristic	B, C, D, K
Standard	IEC 60947-2, EN 60898-1, UL 1077
Poles	1–4
Rated frequency	50/60 Hz
<b>Data acc. to UL1077</b>	
Rated voltage U	600Y/347 V AC
Rated current I	6–63 A
Short-circuit breaking capacity $I_{cc}$	30 (240 V up to 63 A) 14 (277/480Y V up to 63 A) 6 (346/600Y V up to 40 A, 63 A)
Rated insulation voltage $U_i$	600 V AC
Reference temperature for tripping characteristic	B, C, D: 30 °C, K: 40 °C
<b>General data</b>	
Electrical and mechanical endurance	6000 electrical/4000 mechanical
<b>Installation</b>	
Terminal	Failsafe cage terminal
Connection (top/bottom) – Cu only	14–2 AWG (10–30 A, solid or stranded) 1–8 AWG (40–100 A, stranded) Single conductor per terminal, 60/75 °C wire (10–30 A), 60 °C wire (40–100 A)
Tightening torque	3.5 Nm/31 in. lb.
Mounting position	Any
Supply side	Any

## Technical data

### S800P

<b>General data</b>		
Tripping characteristics		B, C, D, K
Standards		IEC/EN 60947-2, UL 1077
Poles		1, 2, 3, 4
Rated current I <sub>n</sub>		80 ... 125 A
Rated frequency f		50/60 Hz
<b>Data acc. to UL 1077/ C22.2 No 235, supplementary protector</b>		
Alternating current: int. cap.		1P
	AC 240 V = 20 kA	(80...100A)
	AC 277 V = 10 kA	(80...100A)
		2P, 3P, 4P
Direct current: int. cap.	AC 240 V = 20 kA	(80...100A)
	AC 277 V = 10 kA	(80...100A)
	DC 125 V (1P) = 10 kA	(80...100A)
	DC 250 V (2P) = 10 kA	(80...100A)
	DC 375 V (3P) = 10 kA	(80...100A)
	DC 500 V (4P) = 10 kA	(80...100A)
<b>Installation</b>		
Terminal		Failsafe cage or ring lug terminal
Connections (top/bottom) – Cu only		1 ... 50 flexible mm <sup>2</sup>
		1 ... 70 Solid (Rigid / Stranded) mm <sup>2</sup>
Tightening torque		3.5 (Nm)
		31 (in-lbs)
Screwdriver		POZI 2
Mounting		EN 60715
Mounting position		Any
Supply		Any

**Approximate dimensions**

S800C, S800S, S800P

**S800C, S800S**

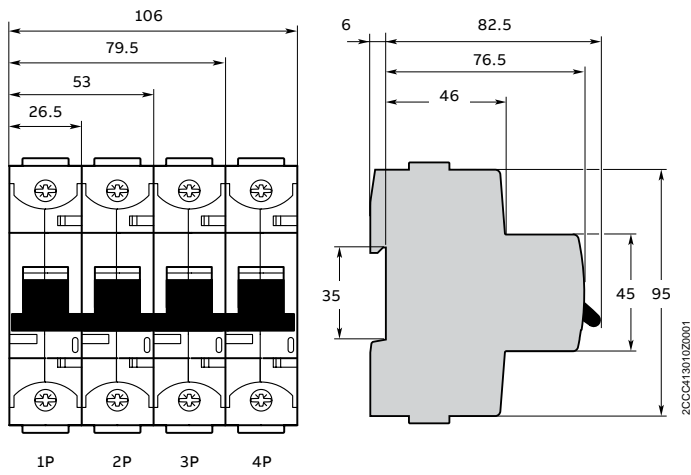

**S800-SOR and S800-UVR**

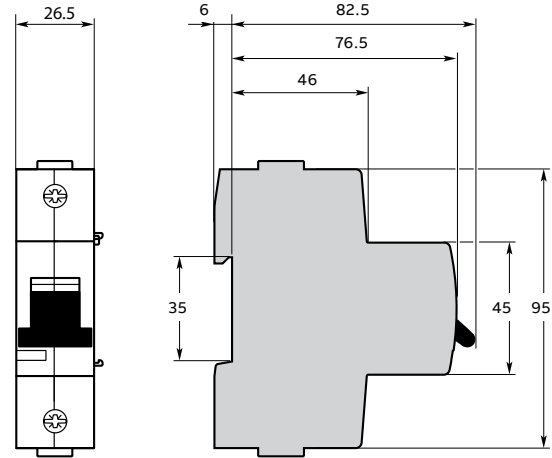

**S800P with cage terminals**

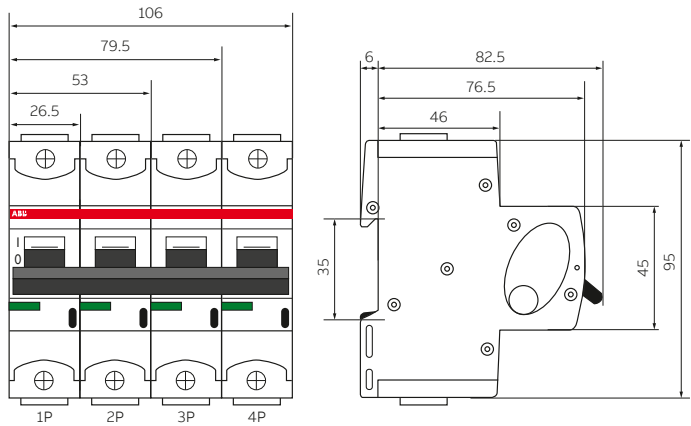

**S800P with ring lug terminals**

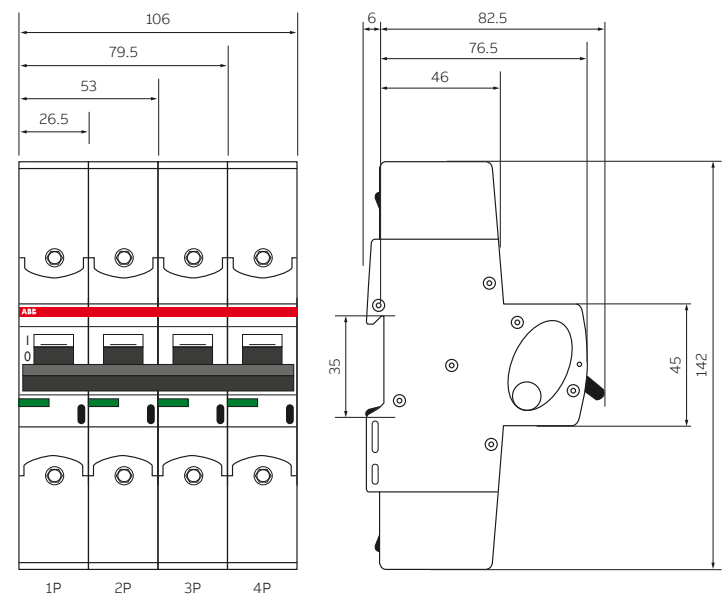

All dimensions shown are in mm.

## Technical data

### S300P

<b>General data</b>	
Tripping characteristics	B, C, D, K, Z
Rated voltage	1P: 277 V AC, 60 V DC 2...4P: 480Y/277 V AC, 125 V DC (2 poles in series)
Rated interrupting capacity	10 kA
Application suppl. prot., for general use.	TC2, OLO, SC:U1
Reference temperature for tripping characteristics	40 °C
Electrical endurance	6,000 ops., 1 cycle (1 s.-ON, 9 s.-OFF)
<b>Mechanical data</b>	
Housing	Insulation group I, RAL 7035
Toggle	Insulation group II, black, sealable
Contact position indication	Real CPI (green OFF / red ON)
Trip position indicator	TPI (gray NO TRIP / orange TRIP)
Protection degree acc. to DIN EN 60529	IP20, IP40 in enclosure with cover
Mechanical endurance	20,000 ops.
Shock resistance acc. to IEC/EN 60068-2-27	25 g - 3 shocks - 18 ms
Vibration resistance acc. to IEC/EN 60068-2-6	5 g - 20 cycles at 5 ... 150 ... 5 Hz at 0.8 In
Environmental conditions (damp heat cyclic) acc. to IEC/EN 60068-2-30	28 cycles with 55 °C/90–96 % and 25 °C/95–100 %
Ambient temperature	-40 ... +70 °C
Storage temperature	-50 ... +70 °C
<b>Installation</b>	
Terminal	Fail-safe bi-directional cylinder-lift terminal
Cross-section of conductors (top/bottom)	Solid, stranded: 35 mm <sup>2</sup> / 35 mm <sup>2</sup> flexible: 25 mm <sup>2</sup> / 25 mm <sup>2</sup> 14–4 AWG
Cross-section of busbars (top/bottom)	10 mm <sup>2</sup> / 10 mm <sup>2</sup> 14–8 AWG
Torque	2.8 Nm; 18 in.-lbs.
Screw driver	No. 2 Pozidrive
Mounting	On 35 mm DIN rail, acc. to EN 60715 by dual DIN-rail release
Mounting position	Any
Supply	Any
<b>Standards</b>	
IEC/EN 60947-2	
IEC/EN 60898-1	
UL 1077	
CSA 22.2. No. 235	
GB/T 14048.2	
GB/T 10963.1	

## Technical data

### ST200MTR — ring tongue terminal / ST200MTR DC



		ST200MTR / ST200MTR DC
Data acc. to UL1077 / CSA 22.2 No.235	Standards	UL1077 / CSA 22.2 No.235
	Poles	1P, 2P, 3P, 4P for AC 1P, 2P and 4P for DC
	Tripping characteristics	K, Z rated tripping current $1.6 \times I_n$ (see tripping curve)
	Rated current $I_n$	$0.5 \leq I_n \leq 63A$
	Rated frequency f	50/60 and DC (0 Hz)
	Rated insulation voltage $U_i$	400 V DC (pollution degree 3)
		500 V DC (pollution degree 2)
	Overvoltage category	III
	Rated voltage	480Y / 277 V AC
		1P: 250 V DC and 2+4P: up to 500 V DC (pollution degree 2)
	Rated interrupting capacity	6 kA AC
		10 kA DC
	Application	Suppl. prot. for general use. Application Codes: TC2, OL0, SC: U1
Reference temperature for tripping characteristics	25 °C	

## S804U-PVS5

The S804U-PVS5 is for GFDI (ground-fault detector interrupter) applications in photovoltaic systems. In case of a ground fault, the breaker will trip and the PV generator will not be damaged. The breaker is tested according to UL 489B for 1000V DC.

### Technical specifications

Standard	UL 489B
Characteristic	PV-S
Rated current $I_n$	5 A
Rated voltage $U_n$	1000V DC
No. of poles	4
Short-circuit current rating acc. to UL 489B	3 kA
Connections 5 A	
Single conductor per terminal—copper only, 75C wire	14–2 AWG Cu, solid or stranded
Tightening torque	3.5 Nm (31 in.lb.)
Protection category	IP40 (actuating end only)
Mounting position	Any
Contacts	Cadmium-free
Reference temperature for tripping characteristic	50 °C
Ambient temperature	-25 °C to 60 °C
Storage temperature	-40 °C to 70 °C
Approval	cULus File #E351317

### Ordering information

	Rated current (A)	Cat. no.
	5	S804U-PVS5



# S804U-PVS5

## Tested and listed wirings

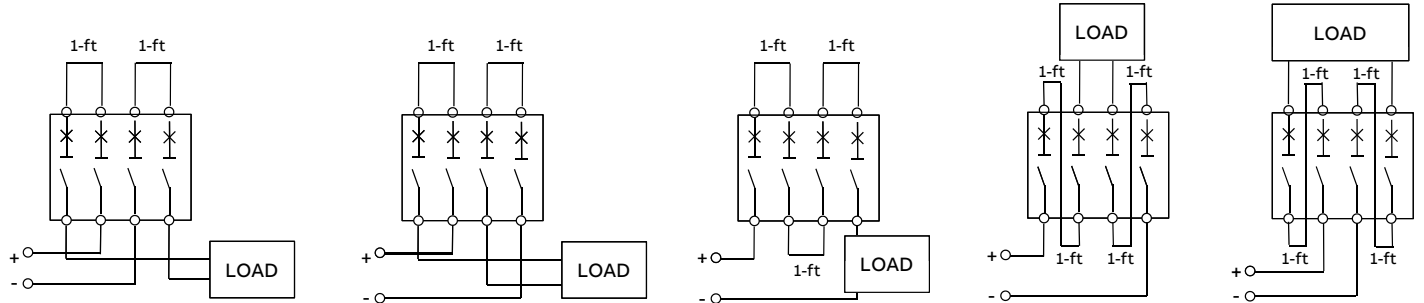

## Trip curve for S804U-PVS5

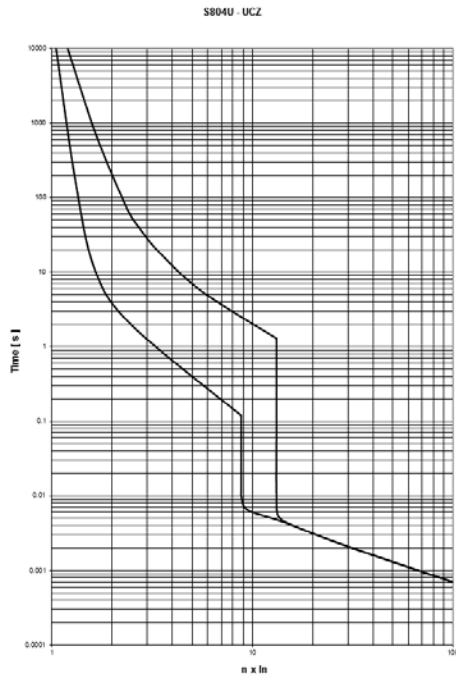

### Tripping behavior acc. to UL 489

Thermal release: 1.13–1.30 x In

Magnetic release: 6 x In

## Dimension S804U-PVS5

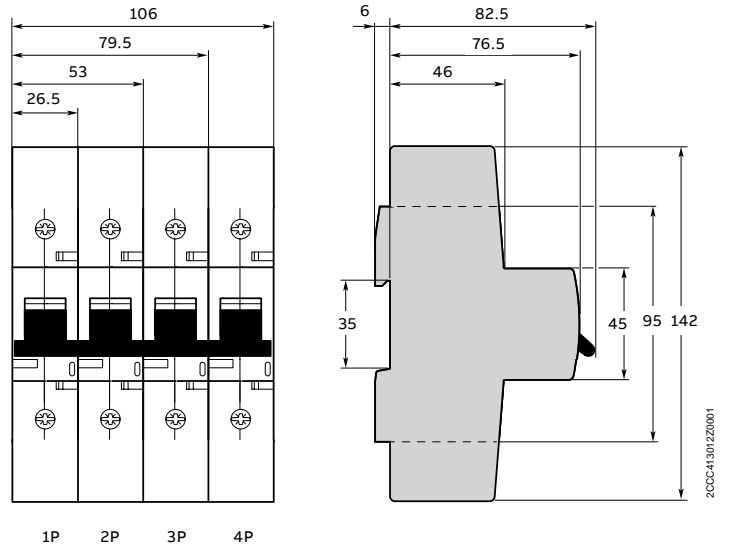

All dimensions shown are in mm.

20CC41301220001

## S803W-SCL-SR UL Short circuit current limiter, self-resetting

UL version short circuit current limiter, self-resetting, 3 pole



Description	Cat. no.
32 A Self-resetting current limiter	S803W-SCL32-SR
63 A Self-resetting current limiter	S803W-SCL63-SR
100 A Self-resetting current limiter	S803W-SCL100-SR

### Technical specifications

<b>Rated voltage</b>	<b>600 V AC per UL508</b>
Short circuit current rating according to UL508, CSA 22.2	480 V AC 50/60 Hz, 65 kA 600 V AC 50/60 Hz, 65 kA

### Approved combinations with motor starter

Downstream devices				Upstream devices			
Rated current				Rated current			
$I_e$ [A]				$I_e$ [A]			
<b>MS/MO325</b>				<b>MS/MO132</b>			
0.1-2.5	•	•	•	0.1-2.5	•	•	•
4	•	•	•	4	•	•	•
6.3	•	•	•	6.3	•	•	•
9	•	•	•	10	•	•	•
12.5	•	•	•	16	•	•	•
16	•	•	•	20	•	•	•
20	•	•	•	25	•	•	•
25	•	•	•	32	•	•	•

-Combinations with S500-K and S500-KM on request.

•Applies for all voltages according to the table below

### Rated ultimate short-circuit breaking capacity

Short-circuit rating according to UL 508, CSA 22.2	kA
(AC) 50/60 Hz 480 V	65
(AC) 50/60 Hz 600 V	65
$I_{cu} = I_{cs}$ according to IEC 60947-2	
(AC) 50/60 Hz 240/415 V	100
(AC) 50/60 Hz 254/440 V	100
(AC) 50/60 Hz 277/480 V	65
(AC) 50/60 Hz 289/500 V	65
(AC) 50/60 Hz 346/600 V	65
(AC) 50/60 Hz 400/690 V	50

## S803W-SCL-SR UL 508 Short circuit current limiter, self-resetting

Approximate dimensions

Minimum cable length between S803W-SCL-SR and downstream devices  
(Connection has to be short-circuit proofed acc. to IEC 61439-1)

MS/M0325  
MS/M0132  
S800

S800-SCL-SR	Min. length X (mm)	Min. cross section (mm <sup>2</sup> )
32 A	80	6
63 A	80	16
100/125 A	250	35

### Diagrams

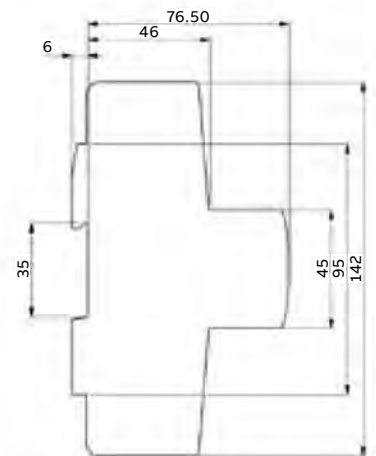
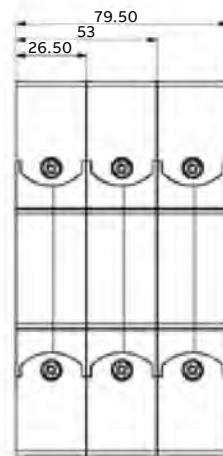
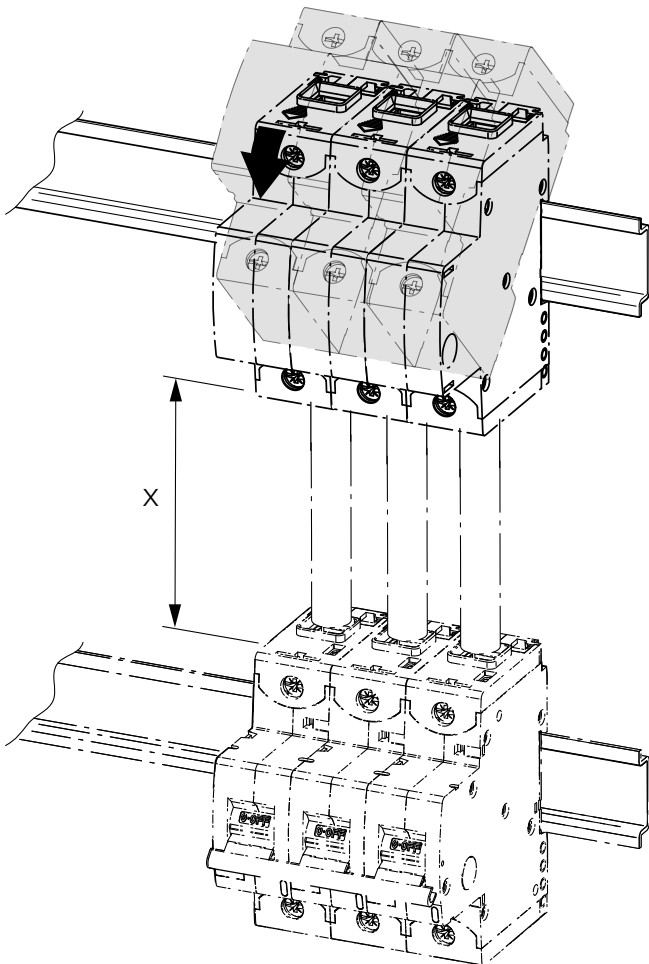

All dimensions shown are in mm.

## Electronic protection device EPD24-TB-101

For use on the load side of 24 V DC switch mode power supplies



### Description

The protection devices EPD24 extend the ABB product range of modular DIN rail components by electronic over-current protection modules for selective protection of 24 V DC load circuits. This protection is achieved by a combination of active electronic current limitation in the case of a short circuit and an overload deactivation from 1.1 x I<sub>N</sub> upwards.

If a fault occurs in a load circuit, the protection device EPD24 will detect this rapidly and reliably, disable the power output transistor and hence interrupt the current flow in the defective circuit. The maximum possible over-current is always limited to 1.3 to 1.8 times the selected rated current. An activation of capacitive loads up to 20,000 µF is possible, deactivation only occurring in the case of overloads or short circuits. Selective deactivation of the defective current circuit means undefined error states and a complete system stop are prevented.

### Features

- Selective load protection, one electronic tripping characteristic
- Active current limitation for safe connection of capacitive loads up to 20,000 µF and on overload/short circuit
- Current ratings 0.5 A to 12 A
- Reliable overload disconnection with 1.1 x I<sub>N</sub> plus
- Manual ON/OFF button
- Clear status and failure indication through LED and integrated auxiliary contact
- Integral fail-safe element adjusted to current rating
- Width per unit only 12.5 mm
- Rail mounting
- Easy wiring through busbar LINE+ and 0 V as well as signal bars
- UL and CSA approvals allow international use of the devices

### Approvals

Authority	Voltage rating	Current ratings
UL 2367	24 V DC	0.5–12 A
UL 1604 (class I, div. 2, groups A, B, C, D)	24 V DC	0.5–12 A
UL 508	24 V DC	0.5–12 A
CSA C22.2 No. 213 (class I, division 2)	24 V DC	0.5–12 A
CSA C22.2 No. 142	24 V DC	0.5–12 A
CSA C22.2 No. 14	24 V DC	0.5–12 A

**ABB Products Proudly Distributed by Gross Automation.**  
**Please call +1 (262) 252-1600 or email [sales@grossautomation.com](mailto:sales@grossautomation.com).**

## EPD24

### Ordering information

#### Electronic protection devices

Rated current $I_n$ A	Weight 1 piece in kg	Packing unit	Cat. no.
0.5	0.065	4	EPD24-TB-101-0.5A
1	0.065	4	EPD24-TB-101-1A
2	0.065	4	EPD24-TB-101-2A
3	0.065	4	EPD24-TB-101-3A
4	0.065	4	EPD24-TB-101-4A
6	0.065	4	EPD24-TB-101-6A
8	0.065	4	EPD24-TB-101-8A
10	0.065	4	EPD24-TB-101-10A
12	0.065	4	EPD24-TB-101-12A

#### Accessories

	Cat. no.	Weight 1 piece in kg	Packing unit
Busbars for LINE+ and 0 V, gray insulation, length 500 mm <sup>1)</sup>	EPD-BB500	0.20	10
Signal bars for auxiliary contacts, gray insulation, length 21 mm	EPD-SB21	0.04	10

1) Ampacity at one line entry  $I_{max} = 50$  A (Recommendation: mid line entry)  
Ampacity at two line entries  $I_{max} = 63$  A

#### Diagram

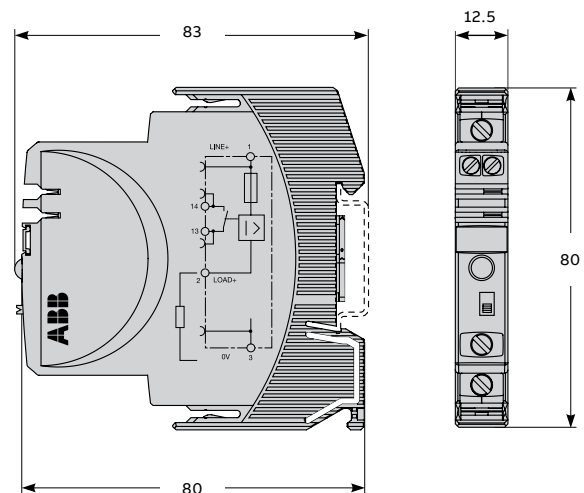

All dimensions shown are in mm.

# Application guide

## Miniature circuit breaker

01 Thermal example:  
The light draws more than 10 amps for an extended period of time, creating a thermal overload.

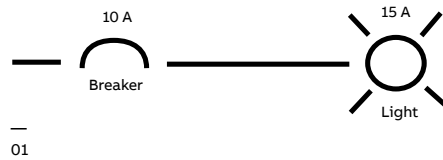

02 Magnetic example:  
The wire connected between the light and breaker is cut and shorted to ground, creating a short circuit.

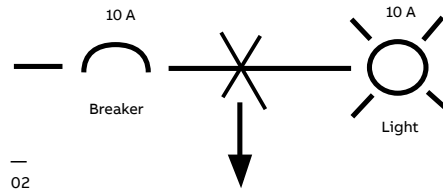

03 ABB current-limiting breaker

Electromagnetic protection

Tripping lever

Operator

Space for identification marker

Operating mechanism

Upper terminal

Thermal protection (bimetal)

Arc chamber

Fixed contact

Moving contact

DIN rail holder

Lower terminal

03

### Introduction

The circuit breaker plays an important role in providing over-current protection and a disconnect means in electrical networks. Recent advancements in circuit breaker technology have increased breaker performance and protection.

### Overload

An overload is a slow and small over-current situation that causes the ampacity and temperature of the circuit to gradually increase over time. This type of event is characterized by a slight increase in the load (ampacity) on the circuit and is interrupted by the thermal trip unit of the breaker.

### Short circuit

A short circuit is a rapid and intense overcurrent situation that causes the ampacity of the circuit to increase. This type of event is characterized by a dramatic increase in the load (ampacity) on the circuit and is interrupted by the magnetic trip unit of the breaker.

### Breaker definition

A breaker is a device designed to isolate a circuit during an over-current event without the use of a fusible element. A breaker is a resettable protective device that protects against two types of over-current situations: overload and short circuit.

ABB Products Proudly Distributed by Gross Automation.

Please call +1 (262) 252-1600 or email [sales@grossautomation.com](mailto:sales@grossautomation.com).

## Circuit breaker construction

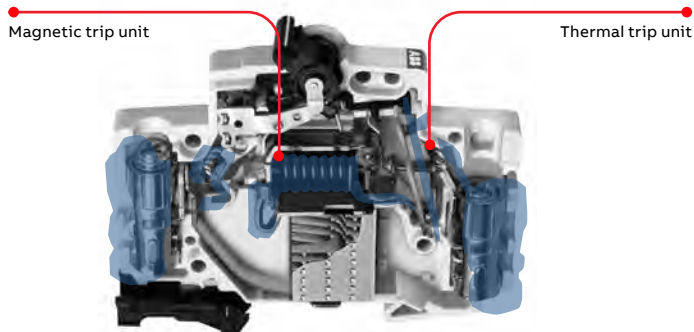

All highlighted components are energized during operation

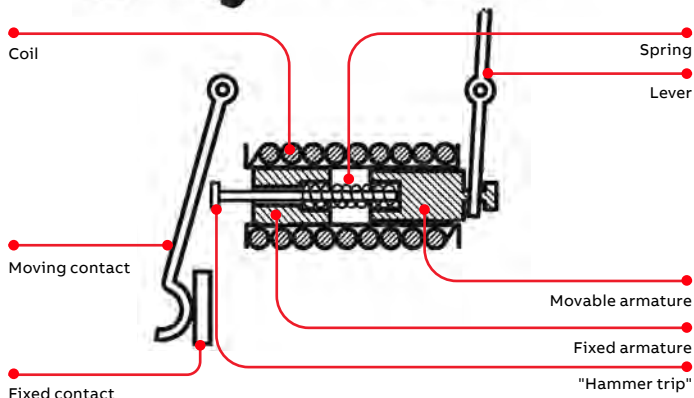
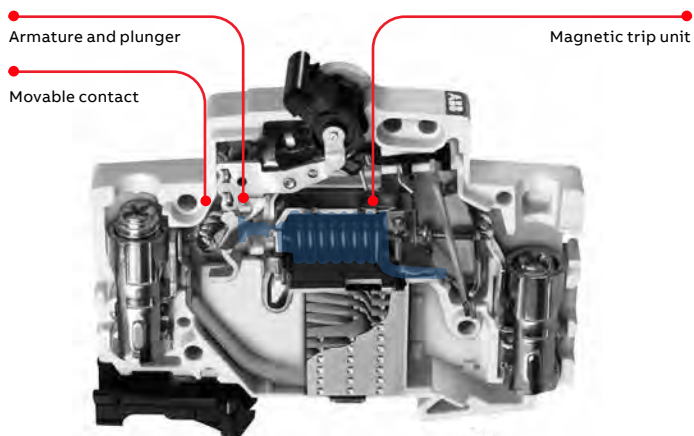
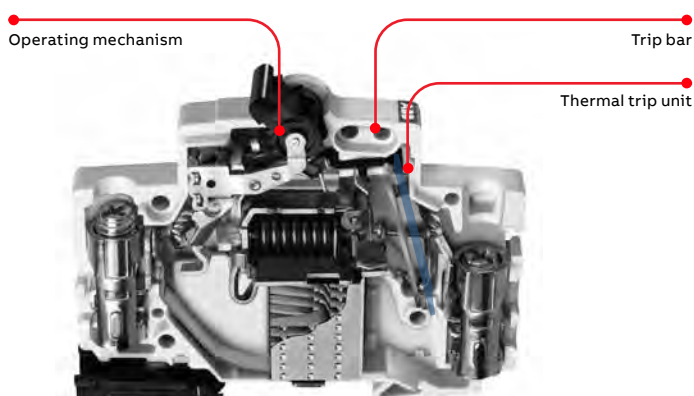

### Thermal/magnetic trip units definition

ABB current-limiting breakers use an electromechanical (thermal/magnetic) trip unit to open the breaker contacts during an over-current event. The thermal trip unit is temperature sensitive and the magnetic trip unit is current sensitive. Both units act independently and mechanically with the breaker's trip mechanism to open the breaker's contacts.

### Current flow during operation

#### Overload protection

The thermal trip unit protects against a continuous overload. The thermal unit is comprised of a bimetal element located behind the circuit breaker trip bar and is part of the breaker's current carrying path. When there is an overload, the increased current flow heats the bimetal, causing it to bend. As the bimetal bends, it pulls the trip bar that opens the breaker's contacts.

The time required for the bimetal to bend and trip the breaker varies inversely with the current. Because of this, the tripping time becomes quicker as current increases in magnitude.

Overload protection is applicable to any installation, conductor or component that can be subjected to low-magnitude but long-time over-currents. Low-magnitude, long-time over-currents can be dangerous because they reduce the life of the electrical installation, conductor and components. If left unchecked, fire could result.

#### Magnetic trip units (short circuit protection)

The magnetic trip unit protects against a short circuit. The magnetic trip unit is comprised of an electromagnet and an armature.

#### Components of a magnetic trip unit

When there is a short circuit, a high magnitude of current passes through the coils, creating a magnetic field that attracts the movable armature towards the fixed armature. The hammer trip is pushed against the movable contact and the contacts are opened. The opening of the breaker's contacts during a short circuit is complete in 0.5 milliseconds.

## Circuit breaker construction

### Arc runners/arc chutes

The arc runner guides the electric arc away from the open contacts into the arc chute, where it is extinguished.

During an overload or short circuit event, the contacts of the breaker separate, and an electrical arc is formed between the contacts through air. The arc is moved into the arc chute by “running” the arc down the interior of the breaker along the arc runner. When the arc reaches the arc chute, it is broken into small segmented arcs. The segmented arcs split the overall energy level into segments less than 25 V. Each 25 V segment does not have a high enough energy level to maintain an arc and all energy is naturally dissipated.

### Breaker curves

#### Thermal trip unit (region one)

The first sloping region of the breaker curve is a graphical representation of the tripping characteristics of the thermal trip unit. This portion of the curve is sloped due to the nature of the thermal trip unit. The trip unit bends to trip the breaker’s trip bar in conjunction with a rise in amperage (temperature) over time. As the current on the circuit increases, the temperature rises, and the faster the thermal element will trip.

Example using the curve below: If you had a 10 amp breaker and the circuit was producing 30 amps of current, the breaker would trip between two seconds and one minute. In this

example, you would find the circuit current on the bottom of the graph (multiples of rated current). The first line is 10 amps (10 amp breaker x a multiple of one), the second line is 20 amps (10 amp breaker x multiple of two), and the third line is 30 amps (10 amp breaker x multiple of three). Next, you would trace the vertical 30 A line up until it intersects the red portion of the breaker thermal curve. If you follow the horizontal lines on both sides of the red curve to the left, you will see that the breaker can trip as fast as two seconds and no slower than one minute.

#### Magnetic trip unit (region two)

This region of the breaker curve is the instantaneous trip unit. ABB’s miniature circuit breaker’s instantaneous trip unit interrupts a short circuit in 2.3 to 2.5 milliseconds. Because of this, the curve has no slope and is graphically represented as a vertical straight line.

See curve example. If you had a 10 amp breaker, the magnetic trip element would interrupt a short circuit between 10 and 30 amps (10 amp breaker x multiple of two and three) in 2.3 to 2.5 milliseconds.

#### Breaker contacts (region three)

This region of the curve is the time required for the contacts of the breaker to begin to separate. The contacts will open in less than 0.5 milliseconds and is graphically represented by the bottom vertical portion of the curve.



ABB Products Proudly Distributed by Gross Automation.

Please call +1 (262) 252-1600 or email [sales@grossautomation.com](mailto:sales@grossautomation.com).

## Circuit breaker current limitation

- 01 Current limiting
- 02 Zero point extinguishing

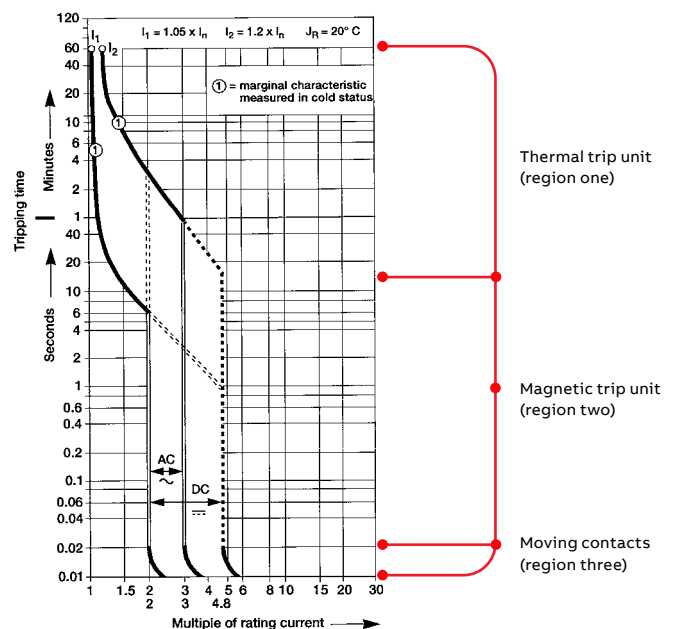
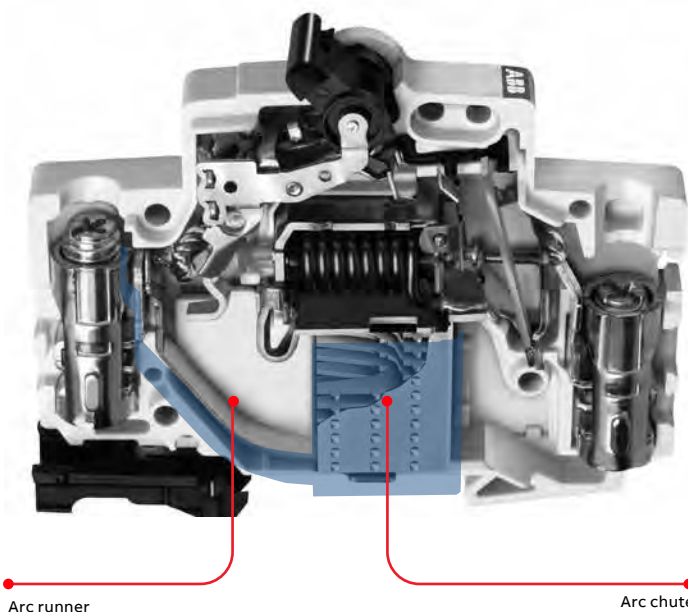
### Current-limiting definitions

All ABB miniature circuit breakers are UL tested and certified as current-limiting protective devices. Current-limiting circuit breakers provide a higher level of circuit protection than typical zero point external breakers.

### UL AC 60 Hz cycle

UL defines an AC cycle as the potential energy of the wave form traveling from zero-to-positive amplitude, positive-to-zero amplitude, zero-to-negative amplitude, negative-to-zero amplitude 60 times in one second. One cycle is completed every 16.6 milliseconds.

### UL breaker current limiting

UL defines breaker current limitation as a breaker that interrupts and isolates a fault in less than ½ of an AC cycle. ½ a cycle is completed in 8.3 milliseconds.

### NEC 240.2 current-limiting

A device that, when interrupting current in its current-limiting range, reduces the current flowing in the faulted circuit to a magnitude substantially less than that obtainable in the same circuit if the device were replaced with a solid conductor having comparable impedance.

### IEC 60947-2 current-limiting circuit breaker

A circuit breaker with sufficiently short trip time to prevent the short-circuit current from reaching the peak value which would otherwise be reached.

### ABB current-limiting breakers

ABB current-limiting breakers can interrupt and isolate a fault in ¼ of an AC cycle. The breaker fault interruption is completed in 2.3 to 2.5 milliseconds.

### Zero point extinguishing breakers

A typical zero point extinguishing breaker interrupts a fault and does not isolate the energy. The breaker allows an arc to be present between the open contacts until the AC wave form crosses zero. When the wave form crosses zero, the potential energy is zero and the arc (fault) naturally extinguishes. The arc could be present for up to 8.3 milliseconds.

### Current-limiting breakers and electrical networks

#### Current limitation

When a short-circuit condition occurs, the “ideal” current-limiting circuit breaker opens before the current waveform can reach its full potential magnitude, which occurs at ¼ cycle (4.17 ms). ABB’s current-limiting breakers can interrupt a fault in about ½ cycle or 2.3 ms to 2.5 ms. ABB’s current-limiting breakers interrupt a short circuit in less than ¼ cycle and limit the amount of current that can reach a circuit. Limiting the available current on the circuit provides additional protection against network, breaker or bus damage and prevents the tripping of upstream breakers (selective coordination).

#### I<sup>2</sup>t

The true destructive nature of a short circuit is measured by the time it is available combined with the peak value of the short circuit. The I<sup>2</sup>qT (amps squared over time) value represents the amount of energy available on a network during a short circuit and is represented by the shaded area on the graphs at left.

During a short circuit, both magnetic forces and thermal energy combine to damage devices on the electrical network. The level of thermal energy and magnetic forces are directly proportional to the square of the current. The magnetic forces vary as a square of the peak current available and the thermal energy varies as a square of the RMS (root mean square) current available.

ABB’s current-limiting breakers will limit the let-through energy to a fraction (1/100) of the value that is available from the network. By comparison, a zero crossing breaker would let through approximately 100 times as much destructive energy as the current-limiting circuit breaker [(100,000 A / 10,000 A) squared – 100X]. ABB’s current-limiting breakers limit the short circuit current to a relatively small magnitude in an extremely short time, which dramatically limits a short circuit’s destructive energy.

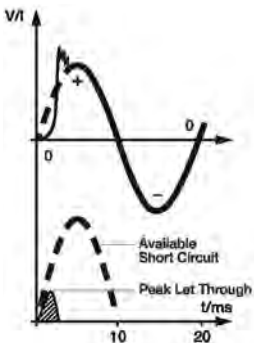

01

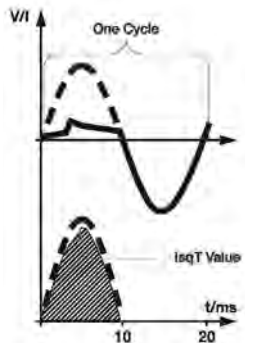

02

## Circuit breaker current limitation

### Current-limiting and zero crossing breakers

During the initial stages of a short circuit, a breaker's contacts open to interrupt the circuit. After the contacts open, an arc forms in the air between the contacts on both the current-limiting and zero crossing breaker contacts. What distinguishes a current-limiting breaker from a zero crossing breaker is what each breaker does after an arc is formed between the open contacts.

A current-limiting breaker "runs" the arc down the breaker arc runner into an arc chute that extinguishes the arc.

A zero crossing breaker does not attempt to extinguish the arc. The breaker is designed to withstand the energy of the arc long enough for the waveform to cross zero. When the wave form crosses zero, the potential energy is zero and the arc naturally extinguishes itself.

ABB's current-limiting breakers interrupt the arc energy in 2.3 ms to 2.5 ms ( $\frac{1}{6}$  cycle), and a zero crossing breaker allows the arc to be present for up to 8.3 ms ( $\frac{1}{2}$  cycle). A zero crossing breaker will let through 100 times as much energy as an ABB current-limiting breaker.

### Current limiting example

The lab test report below details a 20 A S200 series current-limiting breaker interrupting a 28 kA fault in 1.7 milliseconds. The total "I Square T" value is 32.0 kA.

### Zero crossing example

The test report below details a 20 A zero point extinguishing breaker interrupting a 9 kA fault in 9 milliseconds. The total "I Square T" value is 104.0 kA.

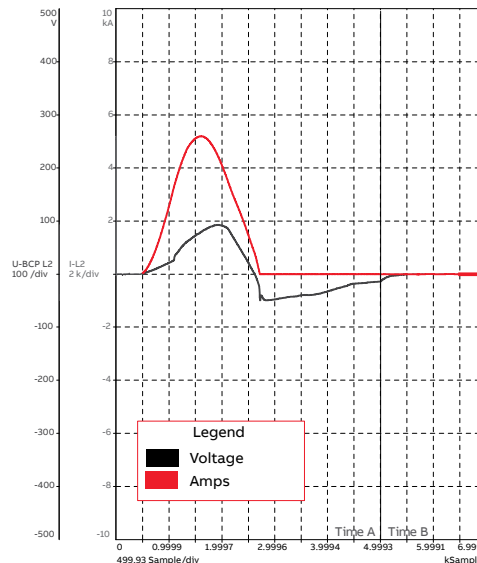
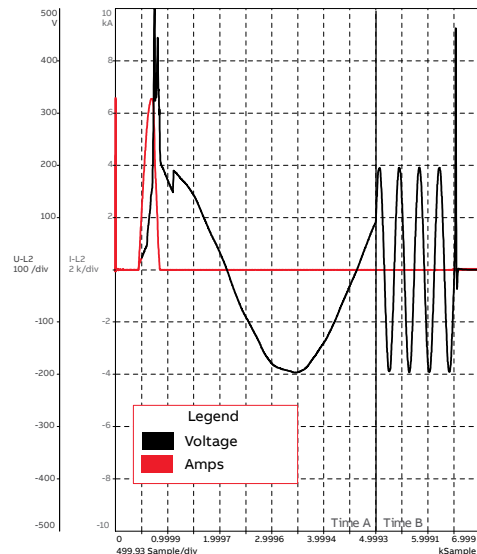
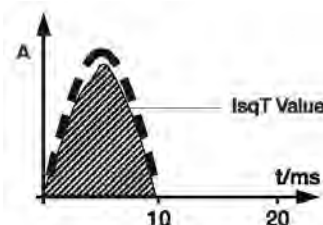
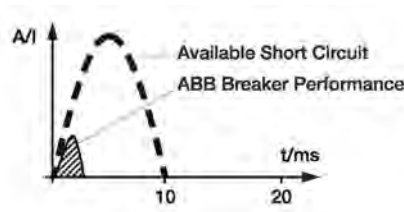

## Selective coordination and series ratings

### Definition of selective coordination

Coordination between the operating characteristics of two or more over-current protection devices, so that when an over-current within established limits occurs, the device designated to operate within those limits trips, whereas the other devices does not trip.

### Example of breaker coordination

When an over-current event occurs at the branch breaker level (CB1), and the event is within the operating characteristics of the breaker, then the branch breaker should interrupt the circuit (open) and the main breaker should remain closed and energized. The chart below gives a graphical representation of a downstream branch breaker (B curve) and a main breaker (A curve) with coordination.

The separation between the curves allows the branch breaker to react to the fault while the main breaker remains closed and energized.

### Example of no breaker coordination

Selective breaker coordination is not achieved when there is an overload event at the branch breaker level (MCB1) and both the branch breaker and main breaker interrupt the circuit (open). When there is no breaker coordination, several circuits lose power that should remain operational during and after the overload event. The chart below gives a graphical representation of a downstream branch breaker (B curve) and a main breaker (A curve) without coordination. There is no separation between the curves. The branch breaker will react to a fault and the main breaker will open and de-energize all circuits down stream. Problems in coordination occur when the branch breaker allows the “I Square T” value of the short circuit to rise to a level that is in the operating range of the upstream main breaker. Proper breaker coordination is easier to achieve with the use of current-limiting breakers at the branch level.

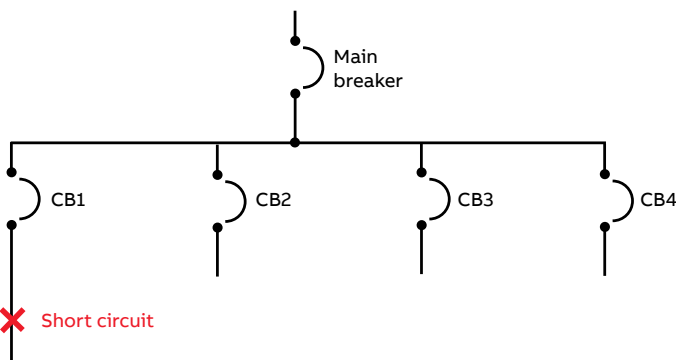

### Selective coordination and current-limiting breakers

Recent improvements in ABB circuit breaker technology has pushed the performance of breakers to the same level as fuses. The reaction time and tripping characteristics of current-limiting breakers are now on par with fuses. This allows ABB to provide a high level of coordination between branch breakers and the main. A current-limiting branch breaker will limit the “I Square T” value well below the level of the operating range of the upstream main breaker. ABB’s current-limiting branch breakers can coordinate between the main breaker up to 35 kA.

### Selective coordination and zero crossing breakers

Zero crossing breakers do not limit the “I Square T” value. They wait for the wave form to cross zero and allow a high level of let-through energy to pass through the system. The “I Square T” value of a zero crossing breaker is high enough that the main breaker will likely trip during a short circuit. With zero crossing breakers, it is extremely difficult to coordinate between branch and main breakers. A typical zero crossing breaker’s coordination level is below 10 kA. There are a few manufacturers that have achieved coordination between a branch zero crossing breaker and the main by slowing the performance (protection) of the main breaker.

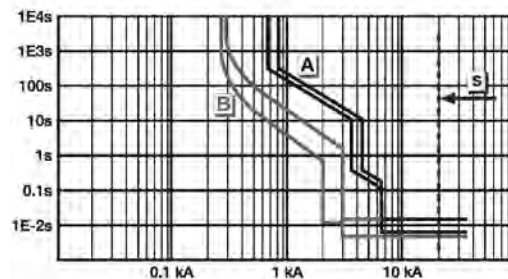

Coordination

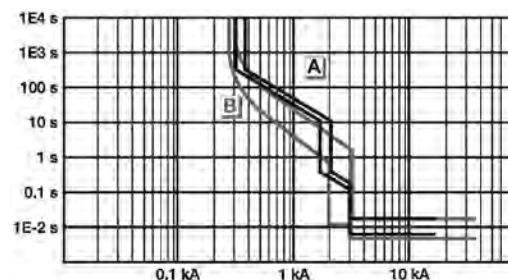

No coordination

**ABB Products Proudly Distributed by Gross Automation.**

**Please call +1 (262) 252-1600 or email [sales@grossautomation.com](mailto:sales@grossautomation.com).**

## Selective coordination and series ratings

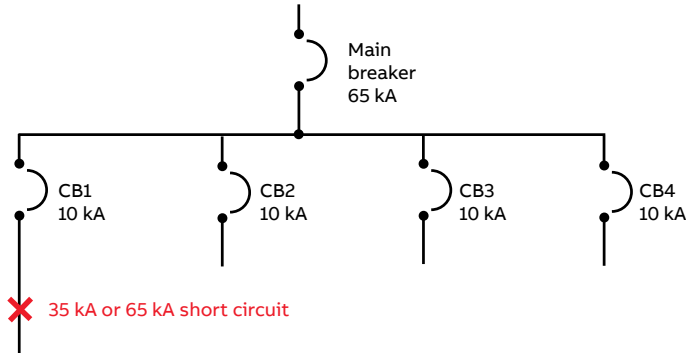

### Selective coordination

Selective coordination is achieved when there is a short circuit on a branch circuit breaker, the branch breaker opens and isolates the fault, and the main breaker remains closed. The rating is usually a value above the “stand alone” interrupting rating of the branch breaker and the “stand alone” rating of the main breaker.

#### Example:

65 kA rated main breaker  
 10 kA rated branch breaker  
 Coordination between the two breakers up to 35 kA

There can be a short circuit on the branch breaker up to 35 kA where the branch will open (CB1) and the main breaker will remain closed. Although the branch has a 10 kA “stand alone” rating, both the breakers work together to limit the available short circuit to allow the branch (CB1) to isolate the fault.

### Series ratings

Series ratings are different from coordination ratings. Unlike coordination ratings where the branch opens and the main remains closed, a series-rated combination is one where both the branch and main breakers open and work together to isolate the fault.

The series-rating combination of two breakers is equal to the “stand alone” interrupting value of the main breaker. This is a result of the main breaker let-through value being lower than the “stand alone” interrupting value of the branch breaker. During a short circuit, the main breaker will limit the energy to a level that is below the “stand alone” value of the branch breaker.

#### Example:

65 kA rated main breaker  
 10 kA rated branch breaker  
 Series-combination rating between the two breakers up to 65 kA

There can be a short circuit on the branch breaker up to 65 kA where the branch will open and the main breaker will open. Although the branch breaker (CB1) has a 10 kA “stand alone” rating, the main breaker has a let-through value below 10 kA. If there is a fault up to 65 kA on the network, the main breaker will limit the energy to a value less than the rating of the branch breaker (CB1). Both breakers will trip (no coordination), but the network can safely withstand a fault of 65 kA.

## Miniature circuit breaker cutaway

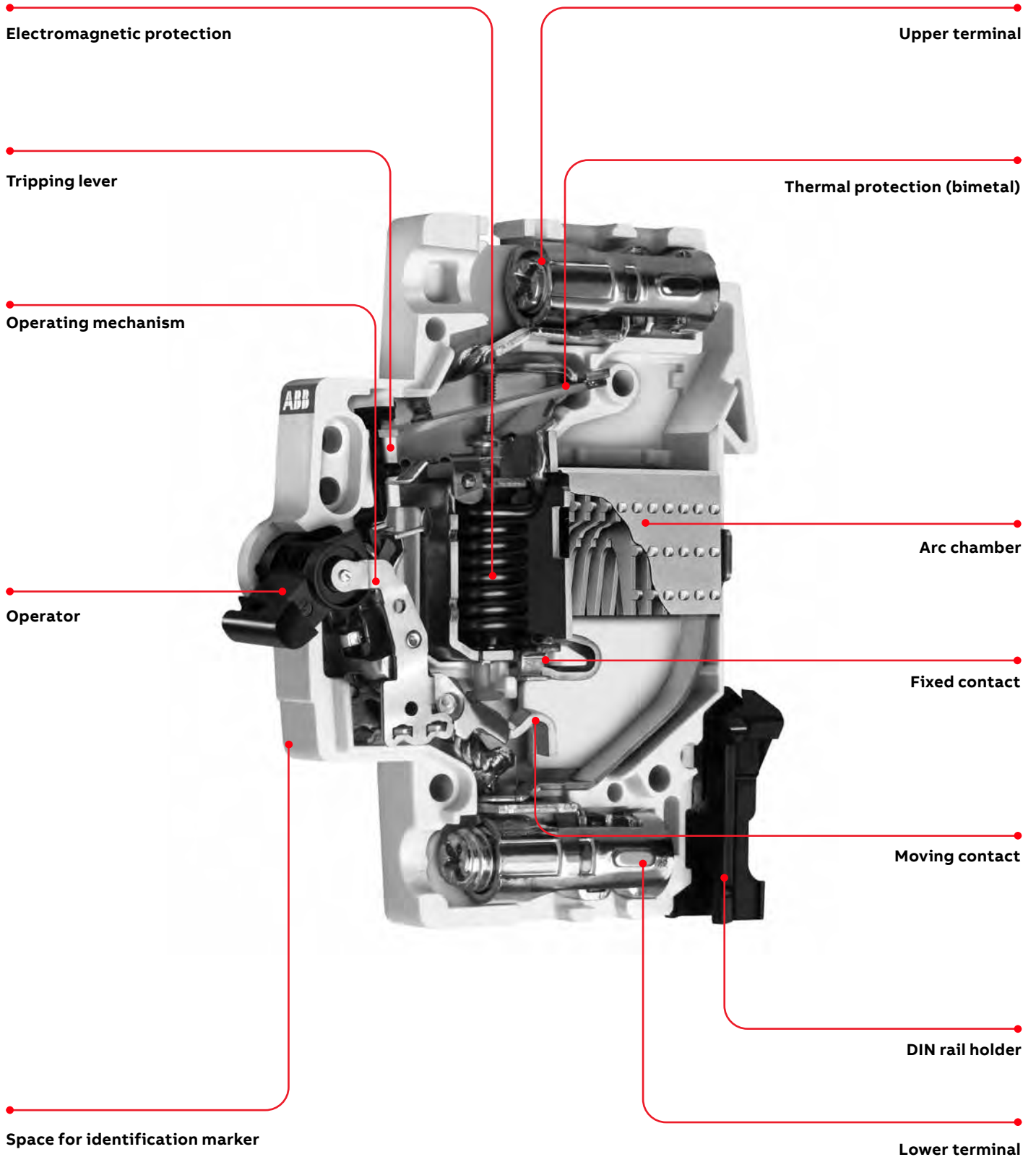



**ABB Products Proudly Distributed by Gross Automation.**  
Please call +1 (262) 252-1600 or email [sales@grossautomation.com](mailto:sales@grossautomation.com).

# Ground-fault protective devices (GFEP)

## F200 series



F200 series GFEPs (ground-fault equipment protectors) are approved according to UL 1053 and IEC 61008.

F200 series GFEPs can be used in branch circuits, together with a corresponding UL 489 circuit breaker, like our SU200M, or in connection with UL 1077 supplementary protectors, like our ST200M wherever branch circuit protection is already provided or not required.

F200 series GFEPs come in versions with 10, 30, 100, 300, and 500 mA ground-fault sensitivity.

F200 GFEPs are also available in short-term delayed versions (AP-R types) as well as selective versions (S types).

F200 GFEPs are A-type GFEPs and can detect AC as well as pulsed DC fault currents.

AC-type devices detect AC fault currents only and are available upon request.

## RCCBs

### F200 technical features



Standards			
Electrical features	Type (wave form of the earth leakage sensed)		
	Poles		
	Rated current I <sub>n</sub>		A
	Rated sensitivity I <sub>Δn</sub>		A
	Rated voltage U <sub>e</sub>	IEC	V
		UL/CSA	V
	Insulation voltage U <sub>i</sub>		V
	Operating voltage range	IEC	V
		UL/CSA	V
	Rated frequency		Hz
	Rated conditional short-circuit current I <sub>nc</sub> =I <sub>Δ</sub> ③	SCPD - fuse gG 100 A	kA
	Rated residual breaking capacity I <sub>Δm</sub> =I <sub>m</sub>		kA
	Rated impulse withstand voltage (1.2/50) U <sub>imp</sub>		kV
	Dielectric test voltage at ind. freq. for 1 min.		kV
	Overvoltage category		
Surge current resistance (wave 8/20)		A	
Mechanical features	Toggle		
	Contact position indicator (CPI)		
	Electrical life		
	Mechanical life		
	Protection degree	housing	
		terminals	
	Environmental conditions (damp heat) acc. to IEC/EN 60068-2-30		°C/RH
Ambient temperature (with daily average ≤ +35 °C)	IEC	°C	
Storage temperature		°C	
Installation	Terminal type		
	Terminal size top/bottom for cable	IEC	mm <sup>2</sup>
		UL/CSA	AWG
	Terminal size top/bottom for busbar	IEC	mm <sup>2</sup>
		UL/CSA	AWG
	Tightening torque	IEC	Nm
		UL/CSA	in-lbs.
	Tool		
	Mounting		
	Mounting position		
Connection			
Withdrawal from busbar			
Dimensions and weight	Dimensions (H x D x W)	2P	mm
		4P	mm
	Weight	2P	g
		4P	g
Combination with auxiliary elements	Combinable with:	auxiliary contact	
		signal contact/auxiliary switch	
		shunt trip	
		undervoltage release	

① Ground-fault sensing and relaying equipment-component (up to 63 A)

② prior to connection of aluminum conductors (≥ 4 mm<sup>2</sup>) ensure that their contact points are cleaned, brushed and coated with grease

③ for S700-E/K 100A, S750-E 63A, S750DR-E/K 63A and other SCPD coordination values see Chapter 3 of Solutions for electrical distribution in buildings - technical details

**ABB Products Proudly Distributed by Gross Automation.**

**Please call +1 (262) 252-1600 or email [sales@grossautomation.com](mailto:sales@grossautomation.com).**

## RCCBs

### F200 technical features

F200 AC	F200 A	F200 A AP-R	F200 A S	F200 A 110V
IEC/EN 61008-1; IEC/EN 61008-2-1, UL 1053 ①				IEC 61008-1; IEC 61008-2-1; UL 1053
AC	A	A	A	A
2P ⑥, 4P (for 125 A only 4P)				2P, 4P
16, 25, 40, 63, 80, 100, 125		25, 40, 63, 80, 100, 125	40, 63, 80, 100, 125	25, 40, 63, 80, 100
0.01-0.03-0.1-0.3-0.5		0.03	0.1-0.3-0.5-1	0.03
230/400 - 240/415				
480Y/277 (up to 100 A)				
500				
In ≤ 100; Right neutral: 110 (170 for 30mA) - 254 ⑤; Left neutral: 195 (250 for 30 mA) - 440 ⑤				110-254
In = 125 A; Right neutral: 185 (150 for 30 mA) - 440 (250 for 30 mA) ⑤;				
Left neutral: 195 (250 for 30 mA) - 440				
In ≤ 100				
110-277 2P RCD				
110-480 4P RCD				
(170 V for 30 mA F200 AC and F200 A)				
50...60				
10 (for 125 A fuse is gG 125 A)				
1 (1.25 for 125 A)				
4				
2.5				
III, disconnecter abilities				
NA		3000	5000	NA
blue sealable in ON-OFF position				
yes				
10000 (2000 for 125 A)				10000
20000 (5000 for 125 A)				20000
IP4X				
IP2X				
28 cycles with 55°C/90-96% and 25°C/95-100%				
-25...+55 (-25...+40 for 125 A)				-25...+55
-40...+70				
failsafe bi-directional cylinder-lift terminal at top and bottom (shock protected) (cage for In > 63 A) ②				
25/25 (35/35 single slot terminal for In > 63 A)				
18-4 (up to 63 A)				-
10/10 (not for In = 80-100 A)				-
18-8 (up to 63 A)				-
2.8 (3 for In = 125 A)				2.8
25 (up to 63 A)				-
Nr. 2 Pozidriv				
on DIN rail EN 60715 (35 mm) by means of fast clip device				
Any				
from top and bottom				
it is possible without using any tools only from the bottom (not for 125 A)				
85 x 69 x 35				
85 x 69 x 70 (85 x 69.5 x 72 for 125 A)				
200				
350 (380 for In = 80 and 100 A and 460 for In = 125A)				
yes (no for 125 A)				
yes				
yes (no for 125 A)				
yes (no for 125 A)				

④ F200 left neutral has not the UL certification and the UL mark

⑤ Only for versions with marking according to EN 61008-1; EN 61008-2-1

⑥ Neutral conductor can be wired anywhere for 2P devices

## RCCBs

F 200 series A  type, 30 mA sensitivity



F202 110V

Number of poles	Rated residual current I $\Delta$ n mA	Rated current In A	Order details	Weight 1 piece kg	Pack unit pc.
			Type code		
2	30	25	F202 A-25/0.03 110V	0.225	1/6
		40	F202 A-40/0.03 110V	0.225	1/6
		63	F202 A-63/0.03 110V	0.225	1/6
		80	F202 A-80/0.03 110V	0.225	1/6
		100	F202 A-100/0.03 110V	0.225	1/6



F204 110V

Number of poles	Rated residual current I $\Delta$ n mA	Rated current In A	Order details	Weight 1 piece kg	Pack unit pc.
			Type code		
4	30	25	F204 A-25/0.03 110V	0.375	1/3
		40	F204 A-40/0.03 110V	0.375	1/3
		63	F204 A-63/0.03 110V	0.375	1/3
		80	F204 A-80/0.03 110V	0.405	1/3
		100	F204 A-100/0.03 110V	0.405	1/3

## RCCBs

F 200 series A  type



F202

### F 200 A type

Number of poles	Rated residual current I $\Delta$ n mA	Rated current In A	Order details	Weight 1 piece	Pack unit	
			Type code	kg	pc.	
2	10	16	F202 A-16/0.01	0.225	1/6	
		25	F202 A-25/0.1	0.225	1/6	
		40	F202 A-40/0.1	0.225	1/6	
		63	F202 A-63/0.1	0.225	1/6	
		80	F202 A-80/0.1	0.225	1/6	
		100	F202 A-100/0.1	0.225	1/6	
	300	25	40	F202 A-40/0.3	0.225	1/6
			63	F202 A-63/0.3	0.225	1/6
			80	F202 A-80/0.3	0.225	1/6
			100	F202 A-100/0.3	0.225	1/6
			500	F202 A-100/0.5	0.225	1/6
	500	25	40	F202 A-40/0.5	0.225	1/6
			63	F202 A-63/0.5	0.225	1/6
			80	F202 A-80/0.5	0.225	1/6
			100	F202 A-100/0.5	0.225	1/6
500			F202 A-100/0.5	0.225	1/6	

ABB Products Proudly Distributed by Gross Automation.

Please call +1 (262) 252-1600 or email [sales@grossautomation.com](mailto:sales@grossautomation.com).

## RCCBs

F 200 series A  type



F204



F204 125 A

Number of poles	Rated residual current I $\Delta$ n mA	Rated current		Order details	Weight 1 piece	Pack unit
		In A	Type code			
4	100	25	F204 A-25/0.1	0.375	1/3	
		40	F204 A-40/0.1	0.375	1/3	
		63	F204 A-63/0.1	0.375	1/3	
		80	F204 A-80/0.1	0.405	1/3	
		100	F204 A-100/0.1	0.405	1/3	
	300	25	F204 A-25/0.3	0.375	1/3	
		40	F204 A-40/0.3	0.375	1/3	
		63	F204 A-63/0.3	0.375	1/3	
		80	F204 A-80/0.3	0.405	1/3	
		100	F204 A-100/0.3	0.405	1/3	
	500	25	F204 A-25/0.5	0.375	1/3	
		40	F204 A-40/0.5	0.375	1/3	
63		F204 A-63/0.5	0.375	1/3		
80		F204 A-80/0.5	0.405	1/3		
100		F204 A-100/0.5	0.405	1/3		

## RCCBs

F 200 series A  type, AP-R



F202

### F 200 AP-R, A type

Short-term delayed tripping. Pulse-current resistant up to 3000 A. Short-term delay 10 ms.

Number of poles	Rated residual current I $\Delta$ n mA	Rated current In A	Order details	Weight 1 piece kg	Pack unit pc.
			Type code		
2	30	25	F202 A-25/0.03 AP-R	0.225	1/6
		40	F202 A-40/0.03 AP-R	0.225	1/6
		63	F202 A-63/0.03 AP-R	0.225	1/6
		80	F202 A-80/0.03 AP-R	0.225	1/6
		100	F202 A-100/0.03 AP-R	0.225	1/6



F204

Number of poles	Rated residual current I $\Delta$ n mA	Rated current In A	Order details	Weight 1 piece kg	Pack unit pc.
			Type code		
4	30	25	F204 A-25/0.03 AP-R	0.375	1/3
		40	F204 A-40/0.03 AP-R	0.375	1/3
		63	F204 A-63/0.03 AP-R	0.375	1/3
		80	F204 A-80/0.03 AP-R	0.405	1/3
		100	F204 A-100/0.03 AP-R	0.405	1/3

## RCCBs

F 200 series A  type, selective



F202



F204

### F 200 A selective type

Number of poles	Rated residual current I $\Delta$ n mA	Rated current In A	Order details	Weight 1 piece kg	Pack unit pc.
			Type code		
2	100	40	F202 A S-40/0.1	0.225	1/6
		63	F202 A S-63/0.1	0.225	1/6
		100	F202 A S-100/0.1	0.225	1/6
	300	40	F202 A S-40/0.3	0.225	1/6
		63	F202 A S-63/0.3	0.225	1/6
		100	F202 A S-100/0.3	0.225	1/6
	500	40	F202 A S-40/0.5	0.225	1/6
		63	F202 A S-63/0.5	0.225	1/6
		100	F202 A S-100/0.5	0.225	1/6

Number of poles	Rated residual current I $\Delta$ n mA	Rated current In A	Order details	Weight 1 piece kg	Pack unit pc.	
			Type code			
4	100	40	F204 A S-40/0.1	0.375	1/3	
		63	F204 A S-63/0.1	0.375	1/3	
		100	F204 A S-100/0.1	0.405	1/3	
	300	40	F204 A S-40/0.3	0.375	1/3	
		63	F204 A S-63/0.3	0.375	1/3	
		100	F204 A S-100/0.3	0.405	1/3	
	500	125	F204 A S-125/0.3	0.500	1	
		40	40	F204 A S-40/0.5	0.375	1/3
			63	F204 A S-63/0.5	0.375	1/3
	100		F204 A S-100/0.5	0.405	1/3	
	125	40	125	F204 A S-125/0.5	0.500	1

ABB Products Proudly Distributed by Gross Automation.

Please call +1 (262) 252-1600 or email [sales@grossautomation.com](mailto:sales@grossautomation.com).

# DS201

## UL and CSA approved RCBO (UL 1053/1077)

### Product description

DS201 UL (1P+N) is a combination of a 30 mA RCD and an MCB with trip curves B, C and K. This product is part of the F200 RCCB series family and replaces the DS951 UL product line. These are available in B and C characteristics from 6 A to 40 A and in K characteristics from 10 A to 20 A.

### Application

Protection of supplementary circuits against overload, short circuit and ground fault.

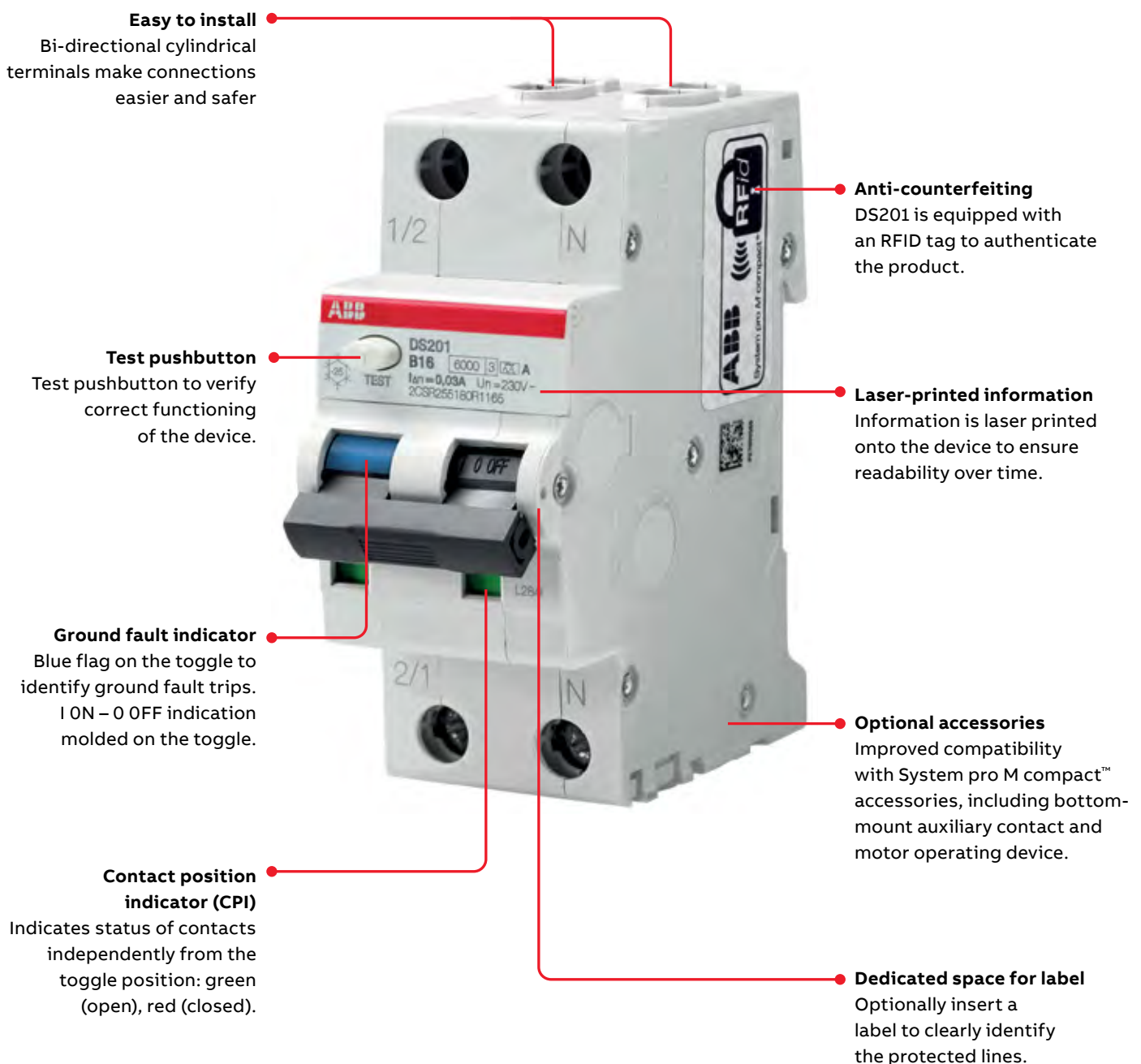

**ABB Products Proudly Distributed by Gross Automation.**

**Please call +1 (262) 252-1600 or email [sales@grossautomation.com](mailto:sales@grossautomation.com).**

## RCBOs

### DS201 UL

		<b>DS201 UL</b>		
Standards		UL 1053, UL 1077, IEC 61009-1, IEC 61009-2-1		
<b>Electrical features</b>	Type (wave form of the earth leakage sensed)		A	
	Number of poles		1P + N	
	Rated current I <sub>n</sub>	A	6 ≤ I <sub>n</sub> ≤ 40	
	Rated sensitivity IΔn	A	0.03	
	Rated voltage U <sub>e</sub>	V	230-240	
	Insulation voltage U <sub>i</sub>	V	500 V AC	
	Overvoltage category		III	
	Pollution degree		2	
	Operating voltage of circuit test U <sub>t</sub>	V	110 – 277	
	Rated frequency	Hz	50/60	
	Rated breaking capacity acc. to To UL 1053, IEC 61009-1, IEC 61009-2-1	A	6 000	
	Rated breaking capacity acc. to IEC 60947-2	ultimate I <sub>cu</sub>	kA	10
		service I <sub>cs</sub>	kA	7.5
	Rated residual breaking capacity IΔm according to IEC 61009-1	IΔm	A	6 000
	Rated impulse withstand voltage (1.2/50) U <sub>imp</sub>	kV		4 kV
	Dielectric test voltage at ind. freq. for 1 min.	kV		2 kV (50 / 60Hz, 1 min.)
	Thermomagnetic release - characteristic	B: 3 I <sub>n</sub> ≤ I <sub>n</sub> ≤ 5 I <sub>n</sub>		■
		C: 5 I <sub>n</sub> ≤ I <sub>n</sub> ≤ 10 I <sub>n</sub>		■
		K: 10 I <sub>n</sub> < = I <sub>n</sub> >= 14 I <sub>n</sub>		■
Rated residual breaking capacity IΔm	A		6 000	
Surge current resistance (wave 8/20 μs)			NA	
<b>Mechanical features</b>	Housing		Insulation group I - II, RAL 7035	
	Toggle		Insulation group II, Black RAL 9005, sealable in ON-OFF positions	
	Contact position indication		Green/Red Window	
	Earth fault trip indication		Blue flag on toggle	
	Electrical life	operations		10000
	Mechanical life	operations		20000
	Protection degree acc. to EN 60529	housing		IP4X
		terminals		IP2X
	Shock resistance acc. to IEC/EN 60068-2-27			25g - 2 shocks - 13ms
	Vibration resistance acc. to IEC/EN 60068-2-6			0.1 mm or 1 g - 20 cycles at 5...150...5 Hz
	Environmental conditions (damp heat) acc. to IEC/EN 60068-2-30	°C / RH		28 cycles with 55°C/90-96% and 25°C/95-100%
	Reference temperature for setting of thermal element	°C / °F		30 / 86
	Ambient temperature (with daily average ≤ +35 °C)	°C / °F		-25...+55 / -13...+131
	Storage temperature	°C / °F		-40...+70 / -40...+158
<b>Installation</b>	Terminal type	top / bottom	Failsafe bi-directional cylinder-lift terminal (shock protected)	
	Terminal size for solid cables	top / bottom	mm <sup>2</sup> / AWG	25/25 / 10/10
	Terminal size for stranded cables	top / bottom	mm <sup>2</sup> / AWG	16/16 / 6/6
	These terminals are not suitable for copper compact stranded conductors			
	Terminal size for busbars	top / bottom	mm <sup>2</sup> / AWG	10/8
	Tightening torque	top / bottom	Nm / in.lb	2.8 / 24.5
	Stripping length of the cable		mm / in	12 / 0.5
	Mounting			on DIN rail EN 60715 (35mm) by means of mounting clip
	Mounting position			Any
	Supply from			Top/Bottom terminals
<b>Dimensions and weight</b>	Dimensions (H x D x W)	mm / in	85 x 69 x 35 / 3.34 x 2.71 x 1.37	
	Weight	g / lb	200 / 0.44	
<b>Combination with auxiliary elements</b>	Combinable with	Auxiliary contact	yes	
	accessories and auxiliaries	Signal contact / auxiliary contact	yes	
		Shunt trip	yes	
		Auxiliary contact for bottom fitting	yes	
		Undervoltage release	yes	
		Overvoltage release	yes	
		Motor operating device	yes	

N.B The combination is mechanically compatible with but no UL approved.

**ABB Products Proudly Distributed by Gross Automation.**  
**Please call +1 (262) 252-1600 or email sales@grossautomation.com.**

## RCBOs

### DS201 UL technical features

#### DS201 UL $\boxed{6000}$ A $\boxed{\Delta}$ type, B characteristic

Function: protection of end user single-phase circuits against overload and short-circuit currents; protection against the effects of sinusoidal alternating and direct pulsating earth fault currents; protection against indirect contact and additional protection against direct contact ( $I_{\Delta n}=30$  mA).

This particular series of devices is UL and CSA approved and is a supplementary protector.

**Application: residential, commercial, industrial.**

**Standard: UL 1053 and 1077, CSA C22.2 No. 144, CSA C22.2 No. 235**



DS201 UL

No. of poles	Rated residual current $I_{\Delta n}$ mA	Rated current $I_n$ A	Bbn 8012542		Order details		Weight 1 piece kg	Pack unit pc.
			EAN	Type code	Order code			
1+N	30	6	577614	DS201 B6 A30 UL	2CSR255187R1065	0.2	1	
		10	565819	DS201 B10 A30 UL	2CSR255187R1105	0.2	1	
		13	590712	DS201 B13 A30 UL	2CSR255187R1135	0.2	1	
		16	578918	DS201 B16 A30 UL	2CSR255187R1165	0.2	1	
		20	567170	DS201 B20 A30 UL	2CSR255187R1205	0.2	1	
		30	576617	DS201 B30 A30 UL	2CSR255187R1305	0.2	1	
		32	564812	DS201 B32 A30 UL	2CSR255187R1325	0.2	1	
		35	588313	DS201 B35 A30 UL	2CSR255187R1355	0.2	1	
		40	576518	DS201 B40 A30 UL	2CSR255187R1405	0.2	1	

#### DS201 UL $\boxed{6000}$ A $\boxed{\Delta}$ type, C characteristic

Function: protection of end user single-phase circuits against overload and short-circuit currents; protection against the effects of sinusoidal alternating and direct pulsating earth fault currents; protection against indirect contact and additional protection against direct contact ( $I_{\Delta n}=30$  mA).

This particular series of devices is UL and CSA approved and is a supplementary protector.

**Application: residential, commercial, industrial.**

**Standard: UL 1053 and 1077, CSA C22.2 No. 144, CSA C22.2 No. 235**



DS201 UL

No. of poles	Rated residual current $I_{\Delta n}$ mA	Rated current $I_n$ A	Bbn 8012542		Order details		Weight 1 piece kg	Pack unit pc.
			EAN	Type code	Order code			
1+N	30	6	588511	DS201 C6 A30 UL	2CSR255187R1064	0.2	1	
		10	576716	DS201 C10 A30 UL	2CSR255187R1104	0.2	1	
		13	564911	DS201 C13 A30 UL	2CSR255187R1134	0.2	1	
		16	589518	DS201 C16 A30 UL	2CSR255187R1164	0.2	1	
		20	577713	DS201 C20 A30 UL	2CSR255187R1204	0.2	1	
		30	590811	DS201 C30 A30 UL	2CSR255187R1304	0.2	1	
		32	579014	DS201 C32 A30 UL	2CSR255187R1324	0.2	1	
		35	567219	DS201 C35 A30 UL	2CSR255187R1354	0.2	1	
		40	589419	DS201 C40 A30 UL	2CSR255187R1404	0.2	1	

**ABB Products Proudly Distributed by Gross Automation.**

**Please call +1 (262) 252-1600 or email [sales@grossautomation.com](mailto:sales@grossautomation.com).**

## RCBOs

### DS201 UL technical features

#### DS201 UL 6000 A $\Delta$ X type, K characteristic

Function: protection of end user single-phase circuits against overload and short-circuit currents; protection against the effects of sinusoidal alternating and direct pulsating earth fault currents; protection against indirect contact and additional protection against direct contact ( $I\Delta n=30$  mA).

This particular series of devices is UL and CSA approved and is a supplementary protector.

**Application: residential, commercial, industrial.**

**Standard: UL 1053 and 1077, CSA C22.2 No. 144, CSA C22.2 No. 235**



DS201 UL

No. of poles	Rated residual current $I\Delta n$ mA	Rated current $I_n$ A	Bbn 8012542 EAN	Order details		Weight 1 piece kg	Pack unit pc.
				Type code	Order code		
1+N	30	10	564713	DS201 K10 A30 UL	2CSR255187R1107	0.2	1
		13	589310	DS201 K13 A30 UL	2CSR255187R1137	0.2	1
		16	577515	DS201 K16 A30 UL	2CSR255187R1167	0.2	1
		20	565710	DS201 k20 A30 UL	2CSR255187R1207	0.2	1



**ABB Products Proudly Distributed by Gross Automation.**  
Please call +1 (262) 252-1600 or email [sales@grossautomation.com](mailto:sales@grossautomation.com).

## E 90. Uncompromising performance

A safe and smart range designed for quick, flexible and error-proof installation

### Compactness

The compact dimensions enable to close the switchboard door even when the fuse holder is open, thus ensuring total safety during maintenance.

### Reliability

Venting grooves and cooling chambers improve heat dissipation even in multiple-pole configurations.



### Completeness

The fuse tripping can be easily displayed, thanks to the special blown fuse indicator light.

### Universal use

Screw holes have increased diameter to accommodate insulated screwdrivers and electric screwdrivers.

## E 90. Uncompromising performance

A safe and smart range designed for quick, flexible and error-proof installation



Fuseholder profile has been designed for maximum ease of use: the 90° flip hinge with ergonomic knob, makes the replacement of fuses easier even in small spaces or when wearing protective gloves.



The compact dimensions enable to close the switchboard door even when the fuseholder is open, thus ensuring total safety during maintenance.



With the Prozidriv PZ2 screws tightening can be performed by exerting less torque than conventional screws, and the same electric screwdriver can be used for all terminals. Moreover, the PS connection busbars facilitate the connecting operations, making the wiring both simple and safe and providing complete integration with S 200 and SN 201 System pro M compact® circuit-breakers.



Venting grooves and cooling chambers improve heat dissipation even in multiple-pole configurations. The reduced operating temperature inside fuseholders ensures durability and reliability of the devices over time.

# Technical data

## E 90 series – data according to UL

Type		E 90/32	E 90/32 PV 1000 V	E 90/32 PV 1500 V
Rated current	[A]	32	32	30
Rated voltage	[V]	690	1000	1500 V DC
Type of current		AC/DC	DC	DC
Fuse		10.3 x 38	10.3 x 38	10x30
Rated frequency	[Hz]	50 - 60	–	6
Tightening torque	[Nm]	PZ2 2 - 2.5	PZ2 2 - 2.5	PZ2 18-22 lb-in
Protection degree		IP20	IP20	IP20
Terminals section	[mm <sup>2</sup> ]	25	25	–
Cross section rigid copper conductors	[AWG]	16÷10	not foreseen	1 wire: 16-10 AWG
Cross section stranded copper conductors	[AWG]	16÷3	8÷3	1 wire: 0.75 -25 (18-4 AWG) 2 wires: 18-6 AWG
Cable temperature	[°C]		[°C] CU 60, 75, 90	max 90 (acc. UL)
Padlockable (when open)		•	•	
Sealable (when closed)		•	•	

Reference Standard	E 90/32	E 90/32 PV 1000 V	E 90/32 PV 1500 V
UL 4248-1	•		
UL 4248-4			
UL 4248-8			
UL 4248-18		•	•

Approvals	E 90/32	E 90/32 PV 1000 V	E 90/32 PV 1500 V
cULus			
UL		•	•
cURus	•		
CSA			

\*\*\*\* IP20 also as standalone device installed on DIN rail, with respect to cables with a cross-section area  $\geq 10 \text{ mm}^2$

E 90/50	E 90/125	E 90/30 CC	E 90/30 J	E 90/60 J
50	125	30	30	360
800	800	600	600	600
AC/DC	AC/DC	AC/DC	AC/DC	AC/DC
14 x 51	22 x 58	Class CC 10.4 x 38	Class J 21 x 57	Class J 27 x 60
50 - 60	50 - 60	60	60	60
PZ2 3 - 3.5	PZ2 3.5 - 4	PZ2 2 - 2.5	PZ2 3.5 - 4	PZ2 3.5 - 4
IP20 ****	IP20 ****	IP20	n.a.	n.a.
35	50	25	50	50
14÷10	14÷10	16÷10	14÷10	14÷10
14÷2	14÷1	16÷3	14÷1	14÷1
.	.	.	.	.
.	.	.	.	.

E 90/50	E 90/125	E 90/30 CC	E 90/30 J	E 90/60 J
.	.	.	.	.
		.	.	.
			.	.

E 90/50	E 90/125	E 90/30 CC	E 90/30 J	E 90/60 J
		.	.	.
.	.	.	.	.

## Protection and safety

### E 90 fuse holders



E 92

#### E 90 fuse holders

E 90 series fuse holders are designed for providing protection against short circuits and overloads. The housing is made of self-extinguishing thermoplastic material resistant to high temperatures (all materials are UL listed) while the contact clips are in silver plated copper.

E 90 fuse holders can be sealed or padlocked to ensure operator safety during maintenance. Versions with blown fuse indicator allow to check whether the fuse is still working correctly or not. For easy and quick installation E 90 range is totally compatible with our UL 508 busbars.

Thanks to cURus approval, they can be installed in UL certified machines.



E 94

#### E 90 fuse switch disconnectors for 10.3 x 38 mm fuses (AC-22B)

Poles	Rated current	Modules	Bbn	Order details	Price 1 piece	Weight 1 piece	Pack unit
			8012542				
	In		EAN	Type code		kg	pc.
1	32	1	009238	E 91/32		0.061	6
1	32	1	024835	E 91/32s		0.062	6
1+N	32	2	008934	E 91N/32		0.130	3
1+N	32	2	515036	E 91N/32s		0.132	3
2	32	2	008835	E 92/32		0.122	3
2	32	2	514930	E 92/32s		0.132	3
3	32	3	047537	E 93/32		0.183	2
3	32	3	020639	E 93/32s		0.184	2
3+N	32	4	047339	E 93N/32		0.252	1
3+N	32	4	514831	E 93N/32s		0.255	1
4	32	4	047230	E 94/32		0.244	1
4	32	4	020530	E 94/32s		0.248	1

s: version with blown fuse indicator light

## Protection and safety

### E 90 PV 1000 V fuse holders



E 90 PV

#### E 90 PV fuse holders

E 90 PV series fuse holders, designed for operating voltages of 1000 V DC with utilization category DC-20B, are particularly suited for protection against overcurrents of photovoltaic systems. The single-pole or two-pole E 90 PV disconnectors for 10.3 x 38mm cylindrical fuse links offer a reliable, compact and affordable solution for photovoltaic installations.

Versions with blown fuse indicator allow to check whether the fuse is still working correctly or not.

#### E 90 PV fuse disconnectors for 10.3 x 38mm fuses (DC-20B)

Poles	Rated current	Modules	Bbn	Order details	Price 1 piece	Weight 1 piece	Pack unit
			8012542				
	In		EAN	Type code		kg	pc.
1	32	1	047131	E 91/32 PV		0.061	6
1	32	1	046936	E 91/32s PV		0.062	6
2	32	2	047032	E 92/32 PV		0.122	3
2	32	2	569138	E 92/32s PV		0.233	3

s: version with blown fuse indicator light

## Protection and safety

### E 90 PV 1500 fuse holder



E 90 PV 1500

#### E 90 PV fuse holder

The E 90 PV 1500 series of fuse holders has been designed for applications up to 1500 V DC. Thanks to their rated voltage up to 1500 V DC they are the ideal solution for protecting cells and inverters. In case of maintenance, they ensure isolation of circuits and strings up to 1500 V in direct current, in total safety. The main features of E 90 PV 1500 fuse holders include venting grooves and cooling chambers which improved heat dissipation.

#### E 90 PV fuse holder for 10 × 85 mm and 10/14 × 85 mm fuses

Poles	Rated current	Width	Bbn	Order details	Price	Weight	Pack
			8012542		1	1 piece	unit
	In		EAN	Type code	piece	kg	pc.
1	32	22.5	020417	E91/32 PV1500e		0.080	5
1	32	22.5	743613	E91/32 PV1500e		0.080	60

## Protection and safety

### E 90 50/125 fuse holders



E 90 50/125

#### 90 50/125 fuse holders

The E 90 50/125 fuse holders range is specifically intended for industrial circuit protection when currents are from 50 A to 125 A. They can, respectively, carry any type of cylindrical fuses 14x51 and 22x58 mm. The E 90 50/125 fuse holders can be sealed or padlocked in open position to ensure operator safety during maintenance operations. Versions with blown fuse indicator (LED) allow checking whether the fuse is still working correctly or not.

#### E 90/50 fuse holders for 14 x 51 mm fuses (AC-20B)

Poles	Rated current In	Modules	Bbn 8012542 EAN	Order details	Price 1 piece	Weight 1 piece kg	Pack unit pc.
				Type code			
1	50	1.5	790228	E 91/50		0.095	4
1	50	1.5	372028	E 91/50s		0.095	4
1+N	50	3	779827	E 91N/50		0.19	2
1+N	50	3	023920	E 91N/50s		0.19	2
2	50	3	779728	E 92/50		0.19	2
2	50	3	070320	E 92/50s		0.19	2
3	50	4.5	779629	E 93/50		0.285	1
3	50	4.5	574828	E 93/50s		0.285	1
3+N	50	6	779520	E 93N/50		0.38	1
3+N	50	6	563020	E 93N/50s		0.38	1

#### E 90/125 fuse holders for 22 x 58 mm fuses (AC-20B)

Poles	Rated current In	Modules	Bbn 8012542 EAN	Order details	Price 1 piece	Weight 1 piece kg	Pack unit pc.
				Type code			
1	100	2	775720	E 91/125		0.135	4
1	100	2	896326	E 91/125s		0.135	4
1+N	100	4	773528	E 91N/125		0.27	2
1+N	100	4	049425	E 91N/125s		0.27	2
2	100	4	771326	E 92/125		0.27	2
2	100	4	049326	E 92/125s		0.27	2
3	100	6	775027	E 93/125		0.405	1
3	100	6	049227	E 93/125s		0.405	1
3+N	100	8	965329	E 93N/125		0.54	1
3+N	100	8	049128	E 93N/125s		0.54	1

s: version with blown fuse indicator light

## Protection and safety

### E 90 CC fuse holders



E 91



E 93

#### Technical features

Type		E 90/30 CC
Rated voltage	[V]	600
Rated current	[A]	30
Type of current		AC/DC
Rated frequency	[Hz]	60
Fuse		class CC
Tightening torque	[Nm]	PZ2 2-2.5*
	[lb-in]	PZ2 18-22**
Terminals cross-section	[mm <sup>2</sup> ]	25
Cross-section rigid copper conductors	1 wire	1.5-25 mm <sup>2</sup> (16-10 AWG)
	2 wires	5 mm <sup>2</sup> (10 AWG)
Cross-section stranded copper conductors	1 wire	1.5-16 mm <sup>2</sup> (16-3 AWG)
	2 wires	2-5 mm <sup>2</sup> (14-10 AWG)
Voltage range for LED indicator light (only s version)	[V]	24 - 1000 AC/DC
Can be sealed closed		■
Can be padlocked open		■

\* PZ2 2.8 Nm in case of rigid copper conductors, 2 wires

\*\* PZ2 24,5 lb-in in case of rigid copper conductors, 2 wires

The E 90 fuse holders for Class CC cylindrical fuse links are specifically designed for the North American market in compliance with the UL standards. In accordance with the reference standards UL 4248-1 and UL 4248-4, they come in voltage and current ratings up to 600V and 30A. They are available in 1P, 1P+N, 2P, 3P, 3P+N and 4P versions. They can be padlocked open and sealed closed.

The E 90 fuse holders are the ideal solution for process control and industrial systems, automation systems, industrial installations and control circuits. The versions with blown fuse indicator light provide a visual signal of the fuse break condition

#### E 90 for class CC cartridge fuses

Poles	Rated current	Modules	Bbn 8012542	Order details	Price 1 piece	Weight 1 piece	Pack unit
	In		EAN	Type code		kg	pc.
1	30	1	998723	E 91/30 CC		0.061	6
1	30	1	998822	E 91/30s CC		0.062	6
1+N	30	2	998921	E 91N/30 CC		0.13	3
1+N	30	2	999027	E 91N/30s CC		0.13	3
2	30	2	999126	E 92/30 CC		0.122	3
2	30	2	999225	E 92/30s CC		0.122	3
3	30	3	999324	E 93/30 CC		0.183	2
3	30	3	999423	E 93/30s CC		0.183	2
3+N	30	4	999522	E 93N/30 CC		0.252	1
3+N	30	4	999621	E 93N/30s CC		0.252	1
4	30	4	999720	E 94/30 CC		0.244	1
4	30	4	999829	E 94/30s CC		0.244	1

s: version with blown fuse indicator light

## Protection and safety

### E 90 J fuse holders



E 90 Class J

#### Technical features

Type		E 90/30 J	E 90/60 J
Rated current	[A]	30	60
Rated voltage	[V]		600
Type of current			AC/DC
Fuse		Class J 1-30A	Class J 31-60A
Rated frequency	[Hz]		60
Tightening torque	[Nm]		PZ2 3.5-4
Terminals cross-section	[mm <sup>2</sup> ]		50
Cross-section rigid copper conductors	[AWG]		14-10
Cross-section stranded copper conductors	[AWG]		14-8
Can be sealed closed			■
Can be padlocked open			■

#### E 90 Class J

The E 90 Class J fuse holders are the ideal solution for industrial systems, industrial installations and control circuits. They are specifically designed for the North American market in compliance with the UL standards. In accordance with the reference standard UL 4248-8, they come in voltage and current ratings up to 600V and 30/60A. They are available in 1P, 2P and 3P versions. The versions with blown fuse indicator light provide a visual signal of the fuse break condition. They can be padlocked open and sealed closed to ensure operator safety during maintenance operations.

#### E 90/30 fuse holders for Class J fuses

Poles	Rated current	Modules	Bbn 8012542	Order details	Price 1 piece	Weight 1 piece	Pack unit
	In		EAN	Type code		kg	pc.
1	30	2	048220	E 91/30 J		0.135	4
2	30	4	048121	E 92/30 J		0.27	2
3	30	6	048022	E 93/30 J		0.405	1
1	30	2	047926	E 91/30s J		0.135	4
2	30	4	047827	E 92/30s J		0.27	2
3	30	6	047728	E 93/30s J		0.405	1

#### E 90/60 fuse holders for Class J fuses

Poles	Rated current	Modules	Bbn 8012542	Order details	Price 1 piece	Weight 1 piece	Pack unit
	In		EAN	Type code		kg	pc.
1	60	2.5	047629	E 91/60 J		0.175	3
2	60	5	049821	E 92/60 J		0.35	1
3	60	7.5	049722	E 93/60 J		0.525	1
1	60	2.5	049623	E 91/60s J		0.175	3
2	60	5	049524	E 92/60s J		0.35	1
3	60	7.5	738824	E 93/60s J		0.525	1

s: version with blown fuse indicator light

## Protection and safety

### Cylindrical fuses E 9F gPV



E 9F PV

Type		E9F PV	E9F PV 1500
Reference standards	-	IEC 60269-6; ROHS 2002/98/CE, UL	IEC 60269-6; ROHS 2002/98/CE, UL
Rated current	[A]	1...30	4...32
Rated operational voltage	[V]	1000 DC	1500 DC
Breaking capacity	[kA]	10	50
Overall dimensions	[mm]	10.3 x 38	10 x 85

#### E 9F PV cylindrical fuses for photovoltaic applications

The E9F PV series of cylindrical fuses has been specifically designed for protecting direct current circuits up to 1500 V DC. Those fuses are the best way to protect the strings, inverters and surge arresters in photovoltaic installations.

The range of E9F PV fuses is available in the 10.3 x 38 mm size for up to 30 A rated current values at a nominal voltage of 1000 V DC or in the 10x85 mm size up to 32 A rated current at a nominal voltage of 1500 V DC.

#### E 9F PV cylindrical fuses 10.3 x 38 mm

Rated current	Bbn 8012542	Order details	Price 1 piece	Weight 1 piece	Pack unit
In	EAN	Type code		kg	pc.
1 A	134568	E 9F1 PV		0.007	10
2 A	134667	E 9F2 PV		0.007	10
3 A	134766	E 9F3 PV		0.007	10
4 A	134865	E 9F4 PV		0.007	10
5 A	134964	E 9F5 PV		0.007	10
6 A	135060	E 9F6 PV		0.007	10
7 A	135169	E 9F7 PV		0.007	10
8 A	135268	E 9F8 PV		0.007	10
10 A	135367	E 9F10 PV		0.007	10
12 A	135466	E 9F12 PV		0.007	10
15 A	135565	E 9F15 PV		0.007	10
20 A	135664	E 9F20 PV		0.007	10
25 A	135763	E 9F25 PV		0.007	10
30 A	135862	E 9F30 PV		0.007	10

#### E9F PV cylindrical fuses 10 x 85 mm

Rated current	Bbn 8012542	Order details	Price 1 piece	Weight 1 piece	Pack unit
In	EAN	Type code		kg	pc.
4 A	339410	E9F4 PV1500		0.010	5
5 A	052852	E9F5 PV1500		0.010	5
6 A	052951	E9F6 PV1500		0.010	5
7 A	053057	E9F7 PV1500		0.010	5
8 A	053156	E9F8 PV1500		0.010	5
10 A	053255	E9F10 PV1500		0.010	5
12 A	053354	E9F12 PV1500		0.010	5
15 A	053453	E9F15 PV1500		0.010	5
20 A	068754	E9F20 PV1500		0.010	5
25 A	068952	E9F25 PV1500		0.010	5
30 A	069058	E9F30 PV1500		0.010	5
32 A	069256	E9F32 PV1500		0.010	5

ABB Products Proudly Distributed by Gross Automation.

Please call +1 (262) 252-1600 or email [sales@grossautomation.com](mailto:sales@grossautomation.com).

# Surge protective devices

## UL 1449 5<sup>th</sup> edition

The Underwriters Laboratories (UL) standard for surge protective devices (SPDs) has been the primary safety standard for surge protection since the first edition was published in 1985. The fifth edition became mandatory for AC SPDs in March 2016.

The objective of UL 1449 has always been to increase safety in terms of surge protection.

### Change in the standard's name: From TVSS to SPDs

Prior to UL 1449 3<sup>rd</sup> Edition taking effect, the devices this standard covers were known as transient voltage surge suppressors (TVSS), operating on power circuits not exceeding 600 V. With the inception of the 3<sup>rd</sup> and 5<sup>th</sup> Edition, these devices are now known as surge protective devices (SPDs), and may operate on power circuits not exceeding 1500 V DC.

This new designation moves the UL standard closer to the international designation and to IEC standards.

### The different Type designations of surge protective devices

The UL 1449 placed SPDs into five different Type categories based on installation location within an electrical system. While Type 1, Type 2 and Type 3 categories refer to different types of SPDs that can be installed at specific locations, Type 4 and Type 5 categories refer to components used in an SPD's configuration.

**Type 1** – “Permanently connected SPDs intended for installation between the secondary of the service transformer and the line side of the service equipment overcurrent device.”

**Type 2** – “Permanently connected SPDs intended for installation on the load side of the service equipment overcurrent device.”

**Type 3** – “Point of utilization SPDs, installed at a minimum conductor length of 10 meters (30 feet) from the electrical service panel.”

**Type 4** – Component assemblies – “Component assembly consisting of one or more Type 5 components together with a disconnect (integral or external) or a means of complying with the limited current tests.”

**Type 1, 2, 3** – Component assemblies – “Consists of a Type 4 component assembly with internal or external short circuit protection.”

**Type 5** – “Discrete component surge suppressors, such as MOVs that may be mounted on a PWB, connected by its leads or provided within an enclosure with mounting means and wiring terminations.”



The closer an SPD is installed to the equipment, the better the protection is. This is a push in the direction of providing stepped protection including external and internal surge protection.

### The measured voltage protection level

The measured limiting voltage (MLV) is the maximum magnitude of voltage measured at the application of a specific impulse wave shape.

When applying a certain surge current on the SPD, the measured voltage at the device terminals is the so called “let-through voltage.”

In UL 1449 2<sup>nd</sup> Edition, the let-through voltage was referred to as suppressed voltage rating (SVR) and was calculated with a 0.5 kA surge wave form at 6 kV. The new designation is voltage protection rating (VPR) and is calculated with a 3 kA surge wave form at 6 kV.

All products you will find in this chapter have been certified according to the UL 1449 5<sup>th</sup> Edition.

The MLV will allow comparison of different types of SPDs with regards to the let-through voltage. However, it is important to note that the surge current used to measure the let-through voltage is six times higher in the 3<sup>rd</sup> and 5<sup>th</sup> Edition than in the 2<sup>nd</sup> Edition. This means that comparing the obsolete SVR designation with the new VPR ratings will not be valid, because VPR ratings will of course be higher than SVR ratings.

**ABB Products Proudly Distributed by Gross Automation.**

**Please call +1 (262) 252-1600 or email [sales@grossautomation.com](mailto:sales@grossautomation.com).**

## Surge protective devices

### OVRT2 series – Selection guide

#### Complete facility protection

Installing surge protection at the main distribution panel is only the beginning of protecting the entire operation. As most transient surges are created internally, it is necessary to install surge protection at sub-distribution panels (equipment protection) to be fully protected. Stepping down the  $I_{max}$  level from the service entrance panel toward equipment to be protected is recommended.

For example, if a 40 kA  $I_{max}$  SPD is installed in the main distribution panel, then 15 kA  $I_{max}$  SPDs should be installed in sub-distribution panels for equipment protection.

#### Coordination

It may be necessary to add a second surge protector, wired to the incoming unit, to achieve the required voltage protection and/or surge capacity. For Type 2 or 4 SPDs, installing this second unit a minimum of 1 m from the first unit will allow the two to work together, achieving the required protection.

#### Wiring rules

The impedance of the cables increases the voltage across the connected equipment. Therefore, the length of the cable between the surge protector and the equipment should be minimized.

The surge protective device should be installed as close to the equipment to be protected as possible. If this is not possible (the equipment is over 30 m from the panel), then a second surge protector must be installed.

#### Choosing the correct model

##### 1) Determine the service voltage

Consult qualified personnel if the facility or operation service voltage is unknown.

##### 2) Select the SPD maximum continuous operating voltage (MCOV, $U_c$ )

The MCOV should correspond to the service voltage. Example: If the service voltage is 480 V Delta, an SPD with 550 V or 660 V MCOV will be required. Surge protection devices must also provide a level of protection compatible with the withstand voltage of the equipment. This withstand voltage depends on the type of equipment and its sensitivity. The incoming surge protector may not provide adequate protection by itself, as certain electrical phenomena may greatly increase its residual voltage if cable lengths exceed 10 m. A second SPD may be necessary.

##### 3) Select the SPD surge capacity ( $I_{max}$ )

Surge capacity is the amount of energy the SPD can withstand from a single surge event. The higher the surge capacity, the longer the device will protect the system. A second surge protector may be required if the surge capacity of the first is not capable of diverting all surge current to ground. See coordination below.

##### 4) Remote monitoring (optional)

Integrated auxiliary contact for remote monitoring available on models with "TS" designation.

Consult "Selection tables" on next page for help in the selection of SPDs.

#### OVR DIN rail SPD – Product type description

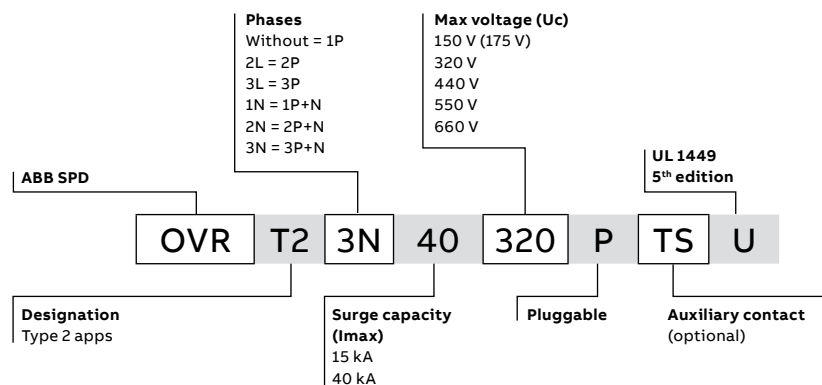

**ABB Products Proudly Distributed by Gross Automation.**

**Please call +1 (262) 252-1600 or email [sales@grossautomation.com](mailto:sales@grossautomation.com).**

## OVRT series

### Product range overview



Name	OVRT2	OVRT2 1N	OVRT2 2L	OVRT2 2N	OVRT2 3L	OVRT2 3N
<b>Number of poles</b>	1p units	1p+N+Gnd	2p+Gnd	2p+N+Gnd	3p+Gnd	3p+N+Gnd
<b>Network type</b>	All networks	Single-phase 2w+Gnd	Split-phase 2w+Gnd	Split-phase 3w+Gnd	Three-phase 3w+Gnd	Three-phase 4w+Gnd
<b>SPD type</b>	Type 4 for Type 2	Type 4 for Type 2	Type 4 for Type 2	Type 4 for Type 2	Type 4 for Type 2	Type 4 for Type 2
<b>Certifications</b>	UL 1449 CSA C22.2 No. 269.4-14	UL 1449 CSA C22.2 No. 269.4-14	UL 1449 CSA C22.2 No. 269.4-14	UL 1449 CSA C22.2 No. 269.4-14	UL 1449 CSA C22.2 No. 269.4-14	UL 1449 CSA C22.2 No. 269.4-14
<b>Marking</b>	cURus, CE	cURus, CE	cURus, CE	cURus, CE	cURus, CE	cURus, CE
<b>Surge ratings</b>	15 kA 40 kA	15 kA 40 kA	15 kA 40 kA	15 kA 40 kA	15 kA 40 kA	15 kA 40 kA
<b>Voltage</b>	Up to 600 V AC	Up to 347 V AC	120/240 V AC	120/240 V AC	Up to 480 V AC	Up to 347/600 V AC
<b>End-of-life signal contact</b>	Only on 40 kA units	Only on 40 kA units	Only on 40 kA units	Only on 40 kA units	Only on 40 kA units	Only on 40 kA units
<b>Replaceable cartridge</b>	Yes	Yes	Yes	Yes	Yes	Yes
<b>SPD technology</b>	MOV	MOV	MOV	MOV	MOV	MOV
<b>Thermally protected</b>	No (upstream protection needed)	No (upstream protection needed)	No (upstream protection needed)	No (upstream protection needed)	No (upstream protection needed)	No (upstream protection needed)

## OVRT2 series

### OVRT2 single-pole



#### Product features

- Type 4 SPD, UL 1449 5th Edition for Type 2 applications
- Metal oxide varistor (MOV) technology
- Single-pole design
- Replaceable and pluggable cartridges
- DIN rail-mounted SPD
- State indication flag standard on all units
- End-of-life signal standard on 40 kA units



Network type	Voltage	MCOV	VPR	Max. disch.	Nominal disch.	Part number	Repl. cartridge	
Pole to be connected between L-N, L-G or L-L	120 V AC	150 V AC	0.6 kV	15 kA	5 kA	OVRT215150PU	OVRT215150CU	
				40 kA	20 kA	OVRT240150PU	OVRT240150CU	
	240...277 V AC	320 V AC	1.0 kV	15 kA	5 kA	OVRT215320PU	OVRT215320CU	
				40 kA	20 kA	OVRT240320PTSU	OVRT240320CU	
	347 V AC	440 V AC	1.3 kV	40 kA	20 kA	OVRT240440PTSU	OVRT240440CU	
	480 V AC	550 V AC	1.7 kV	40 kA	20 kA	OVRT240550PTSU	OVRT240550CU	
	600 V AC	660 V AC	1.9 kV	40 kA	20 kA	OVRT240660PTSU	OVRT240660CU	
	Neutral pole to be connected between N-G	230 V AC	255 V AC	1.2 kV	70 kA	20 kA	OVRT270NPU	OVRT270NCU

#### Electrical characteristics

Operating frequency	(AC) 47–63 Hz
Modes of protection	L-N, L-G, N-G or L-L
Fault rating (SCCR)	200 kAIC – Upstream protection required (breaker / fuse)
Response time	< 25 nanoseconds
Standard monitoring	Cartridge state indicator flag

#### Mechanical characteristics

Weight	0.25 lbs. (120 g)
Housing material	Thermoplastic, gray RAL 7035 / V0
Installation location	Type 1, indoor
Mounting method	DIN rail
Operating temperature	-40 °to 80 °C (-40 °to 175 °F)
Wire range (stranded / solid)	#6–14 AWG / #4–14 AWG
Product design	MOV technology

## OVRT2 series

### OVRT2 1N



#### Product features

- Type 4 SPD, UL 1449 5th Edition for Type 2 applications
- Metal oxide varistor (MOV) technology
- 1p+N+Gnd complete design
- Replaceable and pluggable cartridges
- DIN rail-mounted SPD
- State indication flag standard on all units
- End-of-life signal standard on 40 kA units



Network type	Voltage	MCOV	VPR	Max. disch.	Nominal disch.	Part number	Repl. cartridge
Single-phase 2w+Gnd 	120 V AC	175 V AC	1.2 kV	15 kA	5 kA	OVRT21N15150PU	OVRT215150CU
				40 kA	20 kA	OVRT21N40150PU	OVRT240150CU
						OVRT21N40150PTSU	OVRT240150CU
	240–277 V AC	320 V AC	1.2 kV	15 kA	5 kA	OVRT21N15320PU	OVRT215320CU
				40 kA	20 kA	OVRT21N40320PTSU	OVRT240320CU
				40 kA	10 kA	OVRT21N40440PTSU	OVRT240440CU
480 V AC	550 V AC	1.2 kV	40 kA	10 kA	OVRT21N40550PTSU	OVRT240550CU	
600 V AC	660 V AC	1.2 kV	40 kA	10 kA	OVRT21N40660PTSU	OVRT240660CU	
Neutral pole	230 V AC	255 V AC	1.2 kV	70 kA	20 kA	-	OVRT270NCU

#### Electrical characteristics

Operating frequency	50–60 Hz
Modes of protection	L-N and N-G
Fault rating (SCCR)	200 kAIC – Upstream protection required (breaker / fuse)
Response time	< 25 nanoseconds
Standard monitoring	Cartridge state indicator flag

#### Mechanical characteristics

Weight	0.53 lbs. (240 g)
Housing material	Thermoplastic, gray RAL 7035 / V0
Installation location	Type 1, indoor
Mounting method	DIN rail
Operating temperature	-40 °to 80 °C (-40 °to 175 °F)
Wire range (stranded / solid)	#6–14 AWG / #4–14 AWG
Product design	MOV technology

## OVRT2 series

### OVRT2 2L



#### Product features

- Type 4 SPD, UL 1449 5th Edition for Type 2 applications
- Metal oxide varistor (MOV) technology
- 2p+Gnd complete design
- Replaceable and pluggable cartridges
- DIN rail-mounted SPD
- State indication flag standard on all units
- End-of-life signal standard on 40 kA units



Network type	Voltage	MCOV	VPR	Max. disch.	Nominal disch.	Part number	Repl. cartridge
Split phase 2w+Gnd 	120 V AC	175 V AC	0.6 kV	15 kA	5 kA	OVRT22L15150PU	OVRT215150CU
				40 kA	20 kA	OVRT2240150PTSU	OVRT240150CU
	277 V AC	320 V AC	1.0 kV	15 kA	5 kA	OVRT22L15320PU	OVRT215320CU
				40 kA	20 kA	OVRT22L40320PTSU	OVRT240320CU

#### Electrical characteristics

Operating frequency	50–60 Hz
Modes of protection	L-L and L-G
Fault rating (SCCR)	200 kAIC – Upstream protection required (breaker / fuse)
Response time	< 25 nanoseconds
Standard monitoring	Cartridge state indicator flag

#### Mechanical characteristics

Weight	0.53 lbs. (240 g)
Housing material	Thermoplastic, gray RAL 7035 / V0
Installation location	Type 1, indoor
Mounting method	DIN rail
Operating temperature	-40 °to 80 °C (-40 °to 175 °F)
Wire range (stranded / solid)	#6–14 AWG / #4–14 AWG
Product design	MOV technology

## OVRT2 series

### OVRT2 2N



#### Product features

- Type 4 SPD, UL 1449 5th Edition for Type 2 applications
- Metal oxide varistor (MOV) technology
- 2p+N+Gnd complete design
- Replaceable and pluggable cartridges
- DIN rail-mounted SPD
- State indication flag standard on all units
- End-of-life signal standard on 40 kA units



Network type	Voltage	MCOV	VPR	Max. disch.	Nominal disch.	Part number	Repl. cartridge
Split phase 2w+N+Gnd 	120 V AC	175 V AC	0.7 kV	15 kA	5 kA	OVRT22N15150PU	OVRT215150CU
			0.6 kV	40 kA	20 kA	OVRT22N40150PTSU	OVRT240150CU
	277 V AC	320 V AC	0.7 kV	15 kA	5 kA	OVRT22N15320PU	OVRT215320CU
			1.1 kV	40 kA	20 kA	OVRT22N40320PTSU	OVRT240320CU
			1.4 kV	40 kA	10 kA	OVRT22N40440PTSU	OVRT240440CU
480 V AC	550 V AC	1.8 kV	40 kA	10 kA	OVRT22N40550PTSU	OVRT240550CU	
600 V AC	660 V AC	2.0 kV	40 kA	10 kA	OVRT22N40660PTSU	OVRT240660CU	
Neutral pole	230 V AC	255 V AC	1.2 kV	70 kA	20 kA	-	OVRT270NCU

#### Electrical characteristics

Operating frequency	50–60 Hz
Modes of protection	L-L, L-N, N-G and L-G
Fault rating (SCCR)	200 kAIC – Upstream protection required (breaker / fuse)
Response time	< 25 nanoseconds
Standard monitoring	Cartridge state indicator flag

#### Mechanical characteristics

Weight	0.80 lbs. (360 g)
Housing material	Thermoplastic, gray RAL 7035 / V0
Installation location	Type 1, indoor
Mounting method	DIN rail
Operating temperature	-40 °to 80 °C (-40 °to 175 °F)
Wire range (stranded / solid)	#6–14 AWG / #4–14 AWG
Product design	MOV technology

## OVRT2 series

### OVRT2 3L



#### Product features

- Type 4 SPD, UL 1449 5th Edition for Type 2 applications
- Metal oxide varistor (MOV) technology
- 3p+Gnd complete design
- Replaceable and pluggable cartridges
- DIN rail-mounted SPD
- State indication flag standard on all units
- End-of-life signal standard on 40 kA units



Network type	Voltage	MCOV	VPR	Max. disch.	Nominal disch.	Part number	Repl. cartridge
	120 V AC	175 V AC	0.6 kV	15 kA	5 kA	OVRT23L15150PU	OVRT215150CU
				40 kA	20 kA	OVRT23L40150PTSU	OVRT240150CU
	277 V AC	320 V AC	1.0 kV	15 kA	5 kA	OVRT23L15320PU	OVRT215320CU
				40 kA	20 kA	OVRT23L40320PTSU	OVRT240320CU
	347 V AC	440 V AC	1.3 kV	40 kA	10 kA	OVRT23L40440PTSU	OVRT240320CU
	480 V AC	550 V AC	1.7 kV	40 kA	10 kA	OVRT23L40550PTSU	OVRT240550CU

#### Electrical characteristics

Operating frequency	50–60 Hz
Modes of protection	L-L and L-G
Fault rating (SCCR)	200 kAIC – Upstream protection required (breaker / fuse)
Response time	< 25 nanoseconds
Standard monitoring	Cartridge state indicator flag

#### Mechanical characteristics

Weight	0.80 lbs. (360 g)
Housing material	Thermoplastic, gray RAL 7035 / V0
Installation location	Type 1, indoor
Mounting method	DIN rail
Operating temperature	-40 °to 80 °C (-40 °to 175 °F)
Wire range (stranded / solid)	#6–14 AWG / #4–14 AWG
Product design	MOV technology

## OVRT2 series

### OVRT2 3N



#### Product features

- Type 4 SPD, UL 1449 5th Edition for Type 2 applications
- Metal oxide varistor (MOV) technology
- 3p+N+Gnd complete design
- Replaceable and pluggable cartridges
- DIN rail-mounted SPD
- State indication flag standard on all units
- End-of-life signal standard on 40 kA units



Network type	Voltage	MCOV	VPR	Max. disch.	Nominal disch.	Part number	Repl. cartridge
	120 V AC	175 V AC	0.6 kV	15 kA	5 kA	OVRT23NN15150PU	OVRT215150CU
			1.2 kV	40 kA	20 kA	OVRT23N40150PTSU	OVRT240150CU
	277 V AC	320 V AC	1.2 kV	15 kA	5 kA	OVRT23N15320PU	OVRT215320CU
				40 kA	20 kA	OVRT23N40320PTSU	OVRT240320CU
	347 V AC	440 V AC	1.2 kV	40 kA	10 kA	OVRT23N40440PTSU	OVRT240440CU
	480 V AC	550 V AC	1.2 kV	40 kA	10 kA	OVRT23N40550PTSU	OVRT240550CU
600 V AC	660 V AC	1.2 kV	40 kA	10 kA	OVRT23N40660PTSU	OVRT240660CU	
Neutral pole	230 V AC	255 V AC	1.2 kV	70 kA	20 kA	-	OVRT270NCU

#### Electrical characteristics

Operating frequency	50–60 Hz
Modes of protection	L-L and L-G
Fault rating (SCCR)	200 kAIC – Upstream protection required (breaker / fuse)
Response time	< 25 nanoseconds
Standard monitoring	Cartridge state indicator flag

#### Mechanical characteristics

Weight	1.05 lbs. (480 g)
Housing material	Thermoplastic, gray RAL 7035 / V0
Installation location	Type 1, indoor
Mounting method	DIN rail
Operating temperature	-40 °to 80 °C (-40 °to 175 °F)
Wire range (stranded / solid)	#6–14 AWG / #4–14 AWG
Product design	MOV technology

## OVRT2 series

### Dimensions

#### Dimensions OVRT2

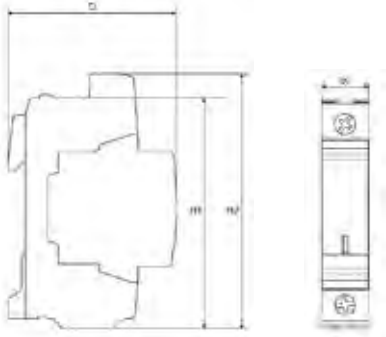

Value	Inches / millimeters
W	0.70 / 17.8
D	2.55 / 64.8
H1 (without TS option)	3.35 / 85.0
H2 (with TS option)	3.88 / 98.5

#### Dimensions OVRT2 1N, OVRT2 2L

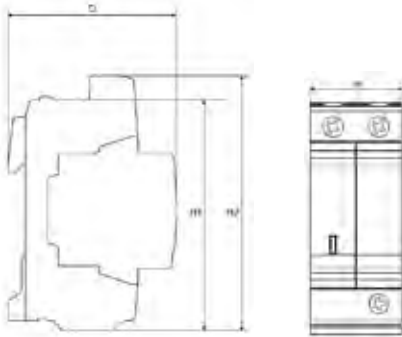

Value	Inches / millimeters
W	1.40 / 35.6
D	2.55 / 64.8
H1 (without TS option)	3.35 / 85.0
H2 (with TS option)	3.88 / 98.5

#### Dimensions OVRT2 2N, OVRT2 3L

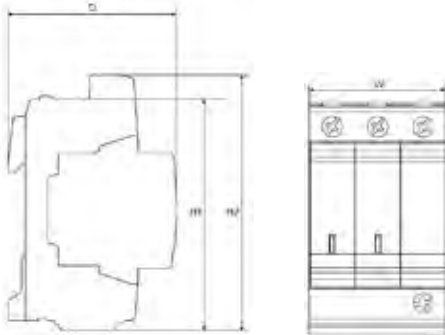

Value	Inches / millimeters
W	2.10 / 53.4
D	2.55 / 64.8
H1 (without TS option)	3.35 / 85.0
H2 (with TS option)	3.88 / 98.5

## OVRT2 series

### Dimensions

#### Dimensions OVRT2 3N

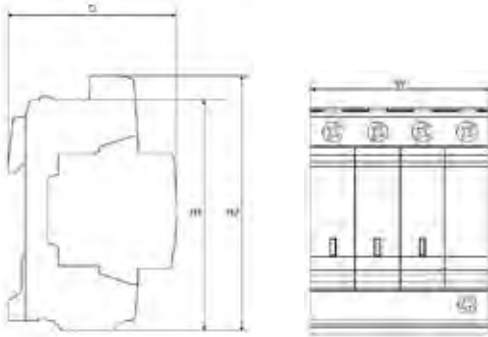

Value	Inches / millimeters
W	2.80 / 71.2
D	2.55 / 64.8
H1 (without TS option)	3.35 / 85.0
H2 (with TS option)	3.88 / 98.5

## OVR PV Type 2 series

### OVR PV surge protective devices Photovoltaic networks

Specifically designed for photovoltaic DC installations, the OVR PV family provide a safe and reliable surge and lightning protection of solar panels and converters.



#### Product features

- Protection mode: DC+ to DC- / DC+ to G / DC- to G
- Protected lines: 2
- Technology: Thermally protected varistor
- Bi-color end of life indicator (green= functional / Red = replace)
- Compact and lightweight design
- Auxiliary contact options
- Pluggable cartridge
- Bottom wiring

#### Technical features

Types		OVR PV T2 40-1000 P	OVR PV T2 40-1500 P
with auxiliary contact (TS)		OVR PV T2 40-1000 P TS	OVR PV T2 40-1500 P TS
Technology		Varistor	Varistor
Electrical features			
Standard		IEC 61643-31 UL 1449 5th Ed	IEC 61643-31 UL 1449 5th Ed
Type/test class		T2/II (EN) & Type 1 CA (UL)	T2/II (EN) & Type 1 CA (UL)
Protected lines		2	2
Types of networks		Photovoltaic	Photovoltaic
Type of current		DC	DC
Nominal voltage Un (L-N/L-L)	[V]	1000	1500
Max. cont. operating voltage Ucpv	[V]	1000	1500
Max. cont. operating voltage according <sup>®</sup> (MCOV)	[V]	1000	1500
Maximum discharge current I <sub>max</sub> (8/20)	[kA]	40	40
Nominal discharge current I <sub>n</sub> (8/20)	[kA]	20	15
Voltage protection level Up at I <sub>n</sub> (L-L/L-PE)	[kV]	4	5
Voltage protection rating according <sup>®</sup> (VPR (L+/G, L-/G, L+/L-))	[kV]	3	4
Response time	[ns]	≤ 25	≤ 25
Residual current IPE	[μA]	≤1000	≤1000
Short-circuit DC current I <sub>scpv</sub>	[A]	10,000	10,000
Short circuit withstand according <sup>®</sup> (S <sub>CCR</sub> )	kAIC	10	10
Disconnecter	Fuse	no need up to 10 kA	no need up to 10 kA
	Circuit breaker	no need up to 10 kA	no need up to 10 kA
Pluggable cartridge		Yes	Yes
Integrated specific thermal disconnecter		Yes	Yes
State indicator		Yes	Yes
Safety reserve		No	No
Auxiliary contact		Yes (TS option)	Yes (TS option)

<b>Installation</b>			
Wire range (L, N, PE)	Solid wire	AWG	4 - 2
	Stranded wire	AWG	4 - 2
Stripping length (L, N, PE)		[inches]	0.47
Tightening torque (L, N, PE)		lbs	35.4
<b>Auxiliary contact (TS)</b>			
Contact complement			1 NO - 1 NC
Minimum load			12 V DC - 10 mA
Maximum load			250 V AC - 1 A
Connection cross-section		AWG	16
<b>Miscellaneous characteristics</b>			
Stocking and operating temperature		Fahrenheit	-40 to +176
Maximal Altitude		ft	6561
Humidity Rate HR			95% (non condensing)
Degree of protection			IP20
Fire resistance according to UL 94			V0
Dimensions	height x width x depth	[inches]	3.5 x 2.12 x 2.87
With auxiliary contacts (TS)	height x width x depth	[inches]	3.89 x 2.12 x 2.87
<b>Replacement Cartridges</b>			
Phase Product ID			OVR PV T2 40-1000 C 2CTB802402R1000
			OVR PV T2 40-1500 C 2CTB802402R1500

**T2 PV series**

Pro- tected lines	Impulse current limp 10/350  kA	Total disch. current total 10/350  kA	Max. dischar. current Imax 8/20  kA	Nominal current  kA	Voltage protec- tion level Up  kV	Max. cont. operat- ing volt- age Ucpv V	Bbn 4053546  EAN	Order details		Weight 1 piece  lbs
								Type code	Order code	
1+1 DC	-	-	40	15	5/5	1500	050240	OVR PV T2 40-1500 P	2CTB802400R1500	0.72
1+1 DC	-	-	40	15	5/5	1500	050288	OVR PV T2 40-1500 P TS	2CTB802401R1500	0.72
1+1 DC	-	-	40	20	4/4	1000	050110	OVR PV T2 40-1000 P	2CTB802400R1000	.66
1+1 DC	-	-	40	20	4/4	1000	050165	OVR PV T2 40-1000 P TS	2CTB802401R1000	.66



OVR PV T2 40-1500 P



OVR PV T2 40-1500 P TS



OVR PV T2 40-1000 P



OVR PV T2 40-1000 P TS

## OVR RS485Q and SL R485 series

### Data and signal SPDs



The ABB range of data and signal surge protective devices are designed to protect sensitive equipment connected to data and telephone lines. These devices complement the OVR power SPD units for a complete and effective system protection solution against power and data surges.

#### Application

OVR RS485Q and SL RS485 series UL 497B listed surge protective devices (SPDs) are specifically designed for RS485 and Fieldbus applications, such as Profibus DP. For installations at service entrances or within the building infrastructure to protect against lightning flashover (typically the service entrance location) and internal transient voltage activity.

Available as compact OVR RS485Q (4-pair) or Slim Line OVR SL RS485 (1-pair) versions for installations where a high number of lines require protection.



OVR SL RS485 and OVR RS485Q/PT have UL 497B approval under UL file QVGO:E240341

Technical specifications and standards		
<b>Key features</b>		
Protection mode		Normal and common
Status indicator		LED status indication option
Technology		Multi-stage hybrid
Installation		DIN rail
Electrical specification		
	OVR SL RS485 series	OVR RS485Q series
Nominal voltage <sup>1</sup>		15 V
Maximum working voltage U <sub>c</sub> (RMS/DC) <sup>2</sup>		11 V / 16.7 V
Current rating (signal)		300 mA
In-line resistance (per line ±10%)		1 Ω
Bandwidth (-3 dB, 50 Ω system)		45 MHz
Transient specification		
Let-through voltage (all conductors) <sup>3</sup> Up		
C2 test 4 kV 1.2/50 μs, 2 kA 8/20 μs to EN/IEC 61643-21		55.0 V
C1 test 1 kV, 1.2/50 μs, 0.5 kA 8/20 μs to EN/IEC 61643-21		42.0 V
B2 test 4 kV 10/700 μs to EN/IEC 61643-21		27.2 V
5 kV, 10/700 μs <sup>4</sup>		28.2 V

<sup>1</sup>Nominal voltage (RMS/DC or AC peak) measured at < 10 μA

<sup>2</sup>Maximum working voltage (RMS/DC or AC peak) measured at < 5 mA

<sup>3</sup>The maximum transient voltage let-through of the protector throughout the test (±10%), line to line and line to ground, both polarities. Response time < 10 ns

<sup>4</sup>Test to IEC 61000-4-5:2006; ITU-T (formerly CCITT) K.20, K.21 and K.45; Telcordia GR-1089- CORE, Issue 2:2002, ANSI TIA/EIA/IS-968-A:2002 (formerly FCC Part 68)

## OVR RS485Q and SL RS485 series

### Data and signal SPDs

Maximum discharge surge current (I <sub>max</sub> )		OVR SL RS485 series	OVR RS485Q series
D1 test 10/350 μs to BS EN/EN/IEC 61643-21:	- Per signal wire 2.5 kA - Per pair	1.25 kA 2.5 kA	2.5 kA 5 kA
8/20 μs to ITU-T K.45:2003, IEEE C62.41.2:2002:	- Per signal wire - Per pair		10 kA 20 kA

Mechanical specification	OVR SL RS485 series	OVR RS485Q series
Temperature range		-40 to +80 °C
Connection type	Screw terminal — max. torque 0.8 N	Pluggable 12-way screw terminal/PT version: Pluggable 12-way screwless push terminal
Max. Conductor size (stranded)	12 AWG/ 4 mm <sup>2</sup>	14 AWG/ 2.5 mm <sup>2</sup>
Ground connection	Via DIN rail or 4 mm <sup>2</sup> ground terminal — max. torque 0.8 Nm	Via DIN rail or M5 threaded hole in base of unit
Case material		FR Polymer UL 94 V-0
Weight	- Unit	0.08 kg/ 0.18 lb
Dimensions		See diagram below

Available configurations			
Catalog number	Global ID	# Pairs	Description
OVRSLRS485UL	7TCA085400R0551	1	Slim Line, RS485, 1 pair + shield/screen
OVRSLRS485LUL	7TCA085400R0552	1	Slim Line, RS485, 1 pair + shield/screen, with LED status indication
OVRSLRS485LMUL	7TCA085400R0600	1	Replacement module for Slim Line, RS485, 1 pair + shield/screen, with LED status indication
OVRRS485QUL	7TCA085400R0572	4	Pluggable screw terminals, RS485, 4 pair + shield/screen for each pair
OVRRS485QPTUL	7TCA085400R0579	4	Pluggable push-in terminals, RS485, 4 pair + shield/screen for each pair

## OVR Q series

### Data and signal SPDs



The ABB OVR Q series of data and signal surge protective devices are designed to protect sensitive equipment connected to data and telephone lines. These devices complement the OVR power SPD units for a complete and effective system protection solution against surges on data and power lines.

#### Application

OVR Q series UL 497B listed surge protective devices (SPDs) are specifically designed for where installation space is at a premium and large numbers of lines require protection. For installations, connect in series with the signal or data line either near where it enters or leaves the building or close to the equipment being protected. Install in a cabinet/cubicle close to the system's ground star to protect against lightning flashover (typically the service entrance location) and internal transient voltage activity.



OVR Q series has UL 497B approval under UL file QVGO:E240341

#### Technical specifications and standards

##### Key features

Protection mode	Normal and common
Status indicator	No
Technology	Multi-stage hybrid
Installation	DIN rail

##### Electrical specification

	OVR Q series
Nominal voltage <sup>1</sup>	30 V
Maximum working voltage $U_c$ (RMS/DC) <sup>2</sup>	26 V/ 37.8 V
Current rating (signal)	–
In-line resistance (per line $\pm 10\%$ )	–
Bandwidth (-3 dB, 50 $\Omega$ system)	–

##### Transient specification

##### Let-through voltage (all conductors)<sup>3</sup> Up

C2 test 4 kV 1.2/50 $\mu$ s, 2 kA 8/20 $\mu$ s to EN/IEC 61643-21	53.0 V
C1 test 1 kV, 1.2/50 $\mu$ s, 0.5 kA 8/20 $\mu$ s to EN/IEC 61643-21	48.0 V
B2 test 4 kV 10/700 $\mu$ s to EN/IEC 61643-21	43.5 V
5 kV, 10/700 $\mu$ s <sup>4</sup>	44.3 V

<sup>1</sup>Nominal voltage (RMS/DC or AC peak) measured at  $< 5 \mu$ A

<sup>2</sup>Maximum working voltage (RMS/DC or AC peak) measured at  $< 5$  mA leakage (OVR 30Q)

<sup>3</sup>The maximum transient voltage let-through of the protector throughout the test ( $\pm 10\%$ ), line to line and line to ground, both polarities. Response time  $< 10$  ns

<sup>4</sup>Test to IEC 61000-4-5:2006, ITU-T (formerly CCITT) K.20, K.21 and K.45, Telcordia GR-1089-CORE, Issue 2:2002, ANSI TIA/EIA/IS-968-A:2002 formerly FCC Part 68)

## OVR Q series

### Data and signal SPDs

Maximum discharge surge current (I <sub>max</sub> )		OVR Q series
D1 test 10/350 μs to	- Per signal wire	2.5 kA
BS EN/EN/IEC 61643-21	- Per pair	5 kA
8/20 μs to ITU-T K.45:2003,	- Per signal wire	10 kA
IEEE C62.41.2:2002:	- Per pair	20 kA

Mechanical specification		OVR Q series
Temperature range		-40 to +80 °C
Installation location	Connect in series with the signal or data line either near where it enters or leaves the building or close to the equipment being protected. Install in a cabinet/cubicle close to the system's ground star point.	
Connection type	Pluggable 12-way screw terminal - maximum torque 0.6 Nm/ PT version: Pluggable 12-way screwless push terminal	
Conductor size (stranded)		2.5 mm <sup>2</sup>
Ground connection	Via DIN rail or M5 threaded hole in base of unit	
Case material		FR polymer UL 94 V-0
Weight:		
- Unit		0.1 kg
- Packaged (each)		0.12 kg
Dimensions		See diagram below

Available configurations			
Catalog number	Voltage	Description	Global ID
OVR30QUL	30 V	With screw terminals	7TCA085400R0568
OVR30QPTUL	30 V	With screwless push terminals	7TCA085400R0575

## OVR SL series

### Data and signal SPDs



The ABB OVR SL series of data and signal surge protective devices are designed to protect sensitive equipment connected to data and telephone lines. These devices complement the OVR power SPD units for a complete and effective system protection solution against surges for data and power lines.

#### Application

OVR SL series UL 497B listed surge protective devices (SPDs) are specifically designed for applications where installation space is at a premium and a large number of lines require protection (e.g., process control, high-speed digital communication equipment or systems with long signal lines).

Connect in series with the data communication or signal line either near or where it enters or leaves the building or close to the equipment being protected (e.g., within its control panel.) It must be close to the system's ground star point. Install the SPD within an existing cabinet/cubicle or in a separate enclosure.



OVR SL series have UL 497B approval under UL file QVGO:E240341

Technical specifications and standards			
Key features			
Protection mode	Normal and common		
Technology	Multi-stage hybrid		
Installation	DIN rail		
Electrical specification	OVR SL06 series	OVR SL30 series	OVR SL180 series
Nominal voltage <sup>1</sup>	6 V	30 V	180 V
Maximum working voltage U <sub>c</sub> (DC) <sup>2</sup>	7.79 V	36.7 V	190 V
Maximum working voltage U <sub>c</sub> (AC RMS)	5 V	25 V	130 V
Current rating (signal)	750 mA	-	250 mA
In-line resistance (per line ±10%)	1 Ω	-	6.8 Ω
Bandwidth (-3 dB 50 Ω system)	45 MHz	-	-

<sup>1</sup>Nominal voltage (RMS/DC or AC peak) measured at < 5 μA

<sup>2</sup>Maximum working voltage (RMS/DC or AC peak) measured at < 5 mA leakage

## OVR SL series

### Data and signal SPDs

Transient specification	OVR SL06 series	OVR SL30 series	OVR SL180 series
<b>Let-through voltage (all conductors)<sup>3</sup> Up</b>			
C2 test 4 kV 1.2/50 $\mu$ s, 2 kA 8/20 $\mu$ s to BS EN/EN/IEC 61643-21	36.0 V	63.0 V	215 V
C1 test 1 kV, 1.2/50 $\mu$ s, 0.5 kA 8/20 $\mu$ s to BS EN/EN/IEC 61643-21	26.2 V	51.3 V	205 V
B2 test 4 kV 10/700 $\mu$ s to BS EN/EN/IEC 61643-21	16.0 V	45.4 V	203 V
5 kV, 10/700 $\mu$ s <sup>4</sup>	17.0 V	46.3 V	200 V
<b>Maximum surge current</b>			
D1 test 10/350 $\mu$ s to EN/EN/IEC 61643-21	- per signal wire BS	1.25 kA	-
	- per pair	2.5 kA	-
8/20 $\mu$ s to ITU-T K.45:2003 IEEE C62.41.2:2002	- per signal wire	10 kA	-
	- per pair	20 kA	-

<sup>3</sup>The maximum transient voltage let-through of the protector throughout the test ( $\pm 10\%$ ), line to line and line to ground, both polarities Response time < 10 ns

<sup>4</sup>Test to IEC 61000-4-5:2006, ITU-T (formerly CCITT) K.20, K.21 and K.45, Telcordia GR-1089-CORE, Issue 2:2002, ANSI TIA/EIA/IS-968-A:2002 (formerly FCC Part 68)

<b>Mechanical specification</b>	
Temperature range	-40 to +80 °C
Installation location	Connect in series with the data communication or signal line either near where it enters or leaves the building or close to the equipment being protected (e.g., within its control panel). Either way, it must be very close to the system's ground star point. Install SPDs either within an existing cabinet/cubicle or in a separate enclosure.
Connection type	Screw terminal - maximum torque 0.8 Nm
Conductor size (stranded)	4 mm <sup>2</sup>
Ground connection	Via DIN rail or 4 mm <sup>2</sup> ground terminal — max. torque 0.8 Nm
Case material	FR polymer UL 94 V-0
Weight	- unit 0.08 kg
Dimensions	See diagram below

<b>Available configurations</b>		
Catalog number	Description	Global ID
OVRSL06UL	6 V slim data SPD for 2-wire signal	7TCA085400R0527
OVRSL06IUL	6 V slim data SPD for 2-wire signal and isolated shield	7TCA085400R0528
OVRSL30UL	30 V slim data SPD for 2-wire signal	7TCA085400R0535
OVRSL30IUL	30 V slim data SPD for 2-wire signal and isolated shield	7TCA085400R0536
OVRSL180UL	180 V slim data SPD for 2-wire signal	7TCA085400R0547

## OVR SL RS485 and OVR RS485Q series

### Dimensions

Dimensions OVR SL RS485	
Value	Inches / millimeters
W	4.19 / 106.5
D	0.28 / 7
H	4.12 / 104.6

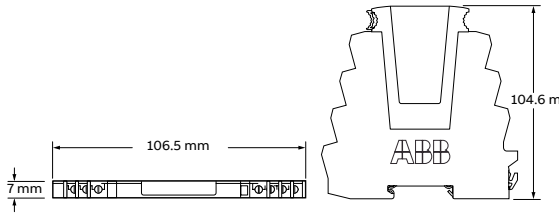

Dimensions OVR RS485Q	
Value	Inches / millimeters
W	3.74 / 95
D	0.71 / 18
H	3.42 / 87

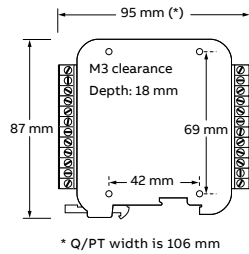

## OVR Q and OVR SL series

### Dimensions

#### Dimensions OVR Q series

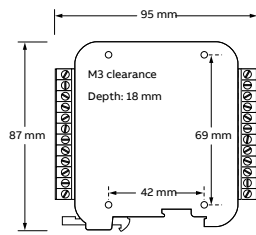

\* Q/PT width is 106 mm

Value	Inches / millimeters
W	3.74 / 95
D	0.71 / 18
H	3.42 / 87

#### Dimensions OVR SL

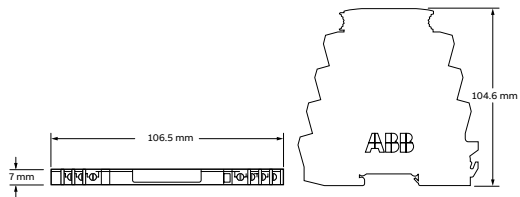

Value	Inches / millimeters
W	4.19 / 106.5
D	0.28 / 7
H	4.12 / 104.6







—  
**ABB Inc.**

305 Gregson Dr.  
Cary, NC 27511  
United States

Customer Service: 800-816-7809

7:00 a.m. - 5:30 p.m., CST, Monday-Friday  
[elec\\_custserv@us.abb.com](mailto:elec_custserv@us.abb.com)

Technical Support: 888-385-1221, Option 1

7:00 a.m. - 5:00 p.m., CST, Monday-Friday  
[lvps.support@us.abb.com](mailto:lvps.support@us.abb.com)

[electrification.us.abb.com](http://electrification.us.abb.com)

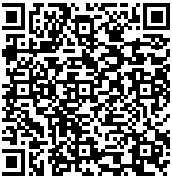

—  
We reserve the right to make technical changes or modify the contents of this document without prior notice. With regard to purchase orders and/or contracts, the agreed particulars shall prevail. ABB Inc. does not accept any responsibility whatsoever for potential errors or possible lack of information in this document.

We reserve all rights in this document and in the subject matter and illustrations contained therein. Any reproduction or utilization of its contents – in whole or in parts – is forbidden without prior written consent of ABB Inc.

© 2023 ABB. All rights reserved.

**ABB Products Proudly Distributed by Gross Automation.**  
**Please call +1 (262) 252-1600 or email [sales@grossautomation.com](mailto:sales@grossautomation.com).**