



innovation
IN CONTROL

Full Line Catalog



Dart Controls Distributed by Gross Automation | +1 (262) 252-1600 or email sales@grossautomation.com

Innovative Products from Dart Controls

| Table of Contents | Page |
|--|-----------|
| AC VARIABLE FREQUENCY DRIVE | 3 |
| •EZ VFD Series..... | 3-4 |
| AC TRIAC VARIABLE VOLTAGE SUPPLY | 5 |
| •AC03/55/57 Series..... | 5-6 |
| DIGITAL SPEED POTS | 7 |
| •ASP10/ASP40 Series..... | 7-8 |
| •DP4..... | 7-8 |
| •DP10- Signal Conditioner/Generator..... | 7-8 |
| ANALOG SCR DRIVES | 9 |
| •150 Series..... | 10-11 |
| •125 Series..... | 12-13 |
| •15 Series..... | 14-15 |
| •130 Series..... | 16-17 |
| •253 Series..... | 18-19 |
| •530 Series..... | 20-21 |
| •Signal Follower and Serial Interface Options..... | 22 |
| DIGITAL SCR DRIVES | 23 |
| •MD Series..... | 23-24 |
| •MD <i>Plus</i> Series..... | 23-24 |
| COMMUTROL™ SERIES BRUSHLESS DC DRIVES | 25 |
| •700/730 Series..... | 25-26 |
| •710/711 Series..... | 25-26 |
| •BLM Series..... | 25-26 |
| LOW VOLTAGE DC PWM DRIVES | 27 |
| •65E Series..... | 27-28 |
| SPEED SENSORS | 29 |
| •PU Series Hall Effect Series..... | 29-30 |
| •Optical/C-Face Hall Series..... | 29-30 |
| ADDITIONAL PRODUCTS | 31 |
| •DM8000 4-in-1 Tachometer..... | 31 |
| •VSI2 Signal Follower/Isolater..... | 31 |

AC Variable Frequency Drives

The EZ VFD® from Dart Controls eliminates the need for complicated and expensive AC drive commissioning, and offers unique features found only in larger, more expensive products.



VF-100E-R

The EZ VFD® from Dart Controls is what the name implies - a V/Hz variable frequency drive that is easy to install and use. The Universal Voltage Supply input will accept any voltage from 110-250VAC (single phase) and produce 3-phase 230VAC. The EZ VFD® comes in both open chassis and standard NEMA 4X enclosed models. Both include a run-relay output to verify operation. On-board monitoring and diagnostics of both load current and peak current, as well as internal component temperatures protect the drive and motor from unforeseen damage. All models include static braking and reversing inputs, as well as voltage signal follower (0-5VDC) capability with isolated signals. And finally, this control will pay for itself with energy bill savings with its standard Power Factor Correction feature in all models. 100% built in the USA and built to last, the EZ VFD® from Dart Controls fits the bill when a simple, reliable variable frequency drive is what you are looking for.



VF-100C-R

Dart Controls Distributed by Gross Automation. | +1 (262) 252-1600 or email sales@grossautomation.com.

AC Variable Frequency Drives Features + Specifications

- Universal Voltage Supply (110-250VAC) 50-70Hz
- Open Chassis and NEMA 4X Enclosed
- Volts/Hz Control
- 8 kHz Switching Freq
- 5-120Hz Output
- Vibration Resistant Single Board Design
- PFC (Power Factor Correction) Saves \$\$
- Power and Error LED
- Multi-Level Current Limit (MCL)[™]
- Over-Temp/Current Limit Auto Shutdown
- Easy Installation and Setup
- Trimpot Adjustment for:
 - MIN Speed
 - MAX Speed
 - Current Limit
 - Acceleration
 - Deceleration
 - Boost (Startup)
 - Brake (DC Inject)
- Removable Trimpot Board - Setup Identical Drives / Prevent Tampering
- Run Relay Output

| Base Model | | | | |
|------------|--------------------------------|------------------------|----------------|--|
| Model | Description / Option | Supply | Output | HP / (Max Phase Amp) |
| VF-100C-R | Open Chassis EZ VFD ® | 110-240VAC | 230VAC 3 Phase | 1/2HP (2.4A) @ 120VAC 1HP (3.2A) @ 230VAC |
| VF-100E-R | NEMA 4X Enclosed EZ VFD ® | 110-240VAC | 230VAC 3 Phase | 1/2HP (2.4A) @ 120VAC 1HP (3.2A) @ 230VAC |
| Options | | | | |
| -29 | Cover mounted reversing switch | Factory Installed only | | |

AC Triac Variable Voltage Supply

Triac Controls adjust the voltage output of an AC supply, similar to a light dimmer or ceiling fan control. Dart offers several models which, when applied properly can be used with single phase AC motors to adjust their speed. They can also be used with resistive loads such as lighting.

It is important to note Triac Controls **will NOT work with capacitor start motors**, perhaps the most common motor found in single phase applications. Capacitor start motors are not designed to be run variable speed. Attempts to slow these motors will be thwarted by the motor capacitor. Visually, these motors have a large hump on the top or side which houses the motor capacitor.

Motors which may have their speed adjusted using a Triac Control include **Permanent Split Capacitor (PSC), Permanent Split Phase (PSP), Shaded Pole and Universal**. These are all single phase motor types which Triac Controls **might** adjust speed - these applications may still have limitations. It is not likely a Triac Control will offer a wide range of speed adjustment - it likely will be in the top half of speed pot adjustment. The user may need to turn the Triac Control output up to get the motor moving before slowing down. Because success is application dependent, it is wise to sample a Triac Control first to evaluate performance in the particular application. Many customers do have success - Dart sells many of these products every year in a wide variety of applications.

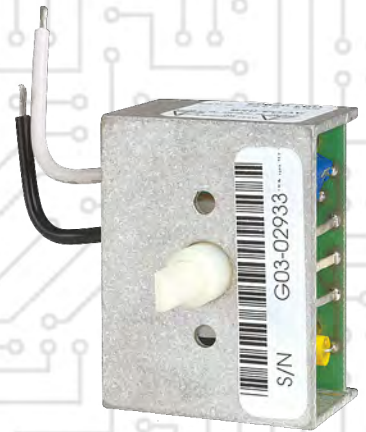

AC-03 Series



55/57 Series

RoHS



55/57 Series



Triac Control Features + Specifications

AC03 Series

- 120VAC supply - 0-120VAC output
- Rated 2.5A continuous
- Output adjust potentiometer includes On/Off switch
- cULs Recognized

55/57 Series

- Chassis and enclosed (NEMA 1) models
- Chassis models include mounting hardware
- Chassis models mount via potentiometer bushing
- 120 and 240VAC supply models, $\pm 10\%$
- 10A and 15A continuous rated models
- -10° to $+45^\circ\text{C}$ ambient temperature
- 50/60Hz operation

| Model | Width | Length | Depth | Weight |
|----------------------------|-----------------------|-----------------------|----------------------|---------------------|
| AC03-05S | 1.50 in [3.81 cm] | 2.00 in [5.08 cm] | 1.10 in [2.79 cm] | 4.8 oz [136 gm] |
| 55/57 Series (chassis) | 2.90 in [7.37 cm] | 3.50 in [8.89 cm] | 2.20 in [5.59 cm] | 5.8 oz [164 gm] |
| 55/57 Series (enclosed) | 4.00 in [10.16 cm] | 5.53 in [14.05 cm] | 3.80 in [9.65 cm] | 1.66 lb [753 gm] |

55/57 Series
Enclosed

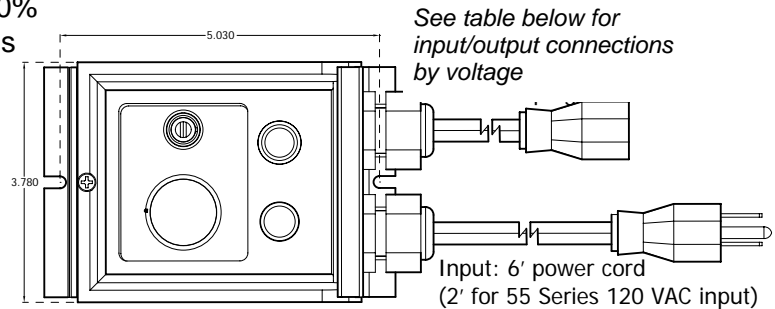

| Base Model | | | | | | Options |
|------------|----------------|---------|-----------------------------|-------------------|-------------------|------------------|
| Model | Supply Voltage | Current | Chassis (C) Enclosed (E) | Supply Connection | Output Connection | Half-Wave Output |
| AC03-05S | 120 VAC | 2.5A | C | Flying Leads | Flying Leads | N/A |
| 55AC10C | 120 VAC | 10A | C | 0.25" male QC | 0.25" male QC | -F* |
| 55AC10E | 120 VAC | 10A | E | 2' cord and plug | Receptacle | -F* |
| 57AC10C | 240 VAC | 10A | C | 0.25" male QC | 0.25" male QC | -F* |
| 57AC10E | 240 VAC | 10A | E | 6' cord and plug | 6' cord with plug | -F* |
| 55AC15C | 120 VAC | 15A | C | 0.25" male QC | 0.25" male QC | -F* |
| 55AC15E | 120 VAC | 15A | E | 2' cord and plug | Receptacle | -F* |
| 57AC15C | 240 VAC | 15A | C | 0.25" male QC | 0.25" male QC | -F* |
| 57AC15E | 240 VAC | 15A | E | 6' cord and plug | 6' cord with plug | -F* |

N/A – Not available

*F - Factory installed only

Digital Speed Pots

Similar to the Digital DC drives, Dart Controls is the exclusive provider of Digital Speed Pots to the market.

A Digital Speed Pot may be either open or closed loop, that can be used with any type, brand or technology drive that accepts a 3-wire speed pot input to change the motor speed. They include the programmable digital display, logic and alarm function and all other features of the Dart MicroDrives, less the drive.

The closed loop versions of these products are the ASP Series. The ASP comes in two styles depending on the application - the **ASP10** (for continuous applications) and the **ASP40** (for start/stop or applications requiring rapid drive response time). The open loop version is the **DP4**.

The programmable display is of particular value to the machine/ process operator, providing drive speed information in meaningful engineering units (GPM, FPM, MM:SS, % of Master, etc.)

Both the ASP Series and the DP4 come in panel mount designs. ASP's may be configured in three modes - Rate, Time and Follower. Follower mode allows for two or more motors to operate at speeds in proportion to each other - a common need in blending, batch and synchronized material feed and handling applications. Many times the logic controller functionality built into the MicroDrive can eliminate the need for a PLC and its custom programming.

The ASP40 offers the additional benefit of a velocity loop PID control algorithm; 4-20mA process signal follower and industrial serial communication. Development will continue on the ASP40 to offer additional serial communication protocols, additional program management tools and a Graphic User Interface (GUI) for both configuration and control.

The DP10 is a panel mounted, multi-purpose signal conditioner that allows the operator easy access to make adjustments to system operations. The DP10 may be used in OEM equipment designs, plant operation or laboratory applications. Most other signal conditioners are DIN rail mounted inside a panel and designed to be set up once - many applications require frequent adjustments to meet application needs. The DP10's unique front-panel design addresses this by making output adjustment easily accessible via convenient up and down pushbuttons with a large, easy to read LED display.



ASP10



ASP40



DP4



DP10



PU-E Series

Performance-matched for use with the ASP Series



RoHS

ASP / DP4 Series Features + Specifications

- Dual Voltage 120/240 VAC, 50/60Hz
- 85-250VAC line voltage operating range
- Closed loop - $\pm 0.1\%$ regulation* (ASP models only)
- For ASP models, encoder required - See Dart PU Series
- Barrier terminal strip - optional plug terminal strip
- Configurable Minimum & Maximum speed
- Configurable Linear Accel & Decel (ASP only)
- Programmable display units
- Uni- and bi-polar output (DP4 only)
- Non-volatile memory retains custom programming
- Program lockout safety feature
- Custom user program memory storage & retrieval
- -10° to +45°C ambient temperature
- 100:1 speed range
- 5Vdc, 50mA sensor supply voltage
- 0-5 to 0-24Vdc sensor input signal range (pulse)
- Configurable alarms with Form C relay output
- Inhibit circuit—permits low power start & stop
- Suitable for wash down applications

| Model | Width | Length | Depth | Weight |
|--------------------|----------------------|----------------------|-----------------------|----------------------|
| ASP10 ¹ | 3.62 in [9.19 cm] | 1.66 in [4.21 cm] | 4.63 in [11.75 cm] | 1.32 lb [0.60 kg] |
| ASP40 ¹ | | | | |
| DP4 ¹ | | | | |
| DP10 ¹ | | | | |

¹ – Front bezel is 4.54 x 2.29 in.



Optimized for use with the Dart PU Series Speed Sensor

*Sensor PPR/application dependent

| Base Model | | | | Options | | | | | | |
|------------|----------------|---|---|---------|-----|-----|-------------------|-----|--------------------|------|
| Model | Supply Voltage | Output | Housing | Body | -P | -1 | OPT3 ¹ | -9 | OPT51 ¹ | -420 |
| ASP10 | 120/240 VAC | Equivalent to a potentiometer. Compatible with 1K Ω to 10M Ω pot circuits | Wash down (NEMA 4X) when installed in similarly rated panel | P | F | F | ✓ | F | N/A | N/A |
| ASP40 | 120/240 VAC | | | P | N/A | F | ✓ | N/A | ✓ | ✓ |
| DP4 | 120/240 VAC | | | P | F | F | ✓ | F | N/A | N/A |
| DP10 | 120/240 VAC | | | P | N/A | N/A | N/A | N/A | N/A | N/A |

P – Panel mount

1- Order as separate line item

✓ - Option is available

F – Option is available as Factory Installed only

N/A – Option Not available

Option Description:

- P: Plug-style terminal strip for ability to remove all wires / harness connection easily
- 1: Provision for external set of Up/Dn push buttons
- OPT3: Option card that boosts signal from 2-wire (non-powered) magnetic proximity sensors
- 9: Blank front bezel overlay (all references to Dart removed)
- OPT51: RS485 Serial Communication card. Field installed only on ASP40.
- 420: 4-20mA isolated input/output card. Factory or field installed (as OPT420). Does NOT supply loop power

Analog SCR Drives

SCR drives are the workhorse of the variable speed DC motor industry. This technology continues to dominate not only installed base but new sales every year, and will continue to do so well into the future. The reason is simplicity, reliability and value.

We refer to the drives in this section as 'Analog' because we also make 'Digital' SCR drives – more on those in the next section.

SCR drives convert single phase line voltage (120/240VAC) into full-wave rectified DC for use with both DC permanent magnet and shunt or field wound DC motors. SCR drives control the motor speed by adjusting the voltage output to the drive. Current (amp) draw is determined by the motor and its load – drives with Current Limit feature will protect both the motor and control from damage.

Dart drives are designed with both the OEM designer and the user in mind – some common features include:

- Auto-sensing dual supply voltage (120 or 240VAC)
- Wide adjustable HP range – no troublesome HP resistors
- Both 'chassis' (open frame) and enclosed model options
- Popular options to address reversing, signal following, wash down, and computer/plc interface using serial comm's
- Continued investment in product development and improvement

All Dart products are 100% designed and built in the USA, backed by a generous warranty policy. Most products ship in 24 hours or less from our ISO certified, Lean Manufacturing facility.

Service and Support are what separate us from the rest – we appreciate the opportunity to discuss your application needs and invite your call any time. Experience the Dart Difference for yourself today!



150 Series



125 Series



253 Series



15 Series

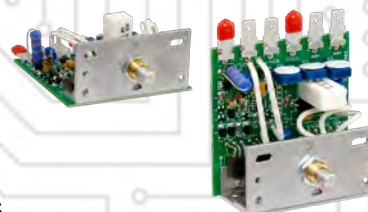

530 Series



130 Series



150 Series



The 150 Series from Dart is the latest SCR drive offering, designed specifically with the OEM in mind. This drive is complete with all the features the OEM designer may require, with the flexibility to add and subtract features as needed.

Other suppliers have effectively abandoned any development of SCR drives – Dart believes there will always be applications for DC motors and drives. For that reason, Dart has developed specifically for the 150 Series a number of industry unique and innovative features and options, including:

- ✓ 2 choices of wiring terminations
- ✓ Fusing options for line, armature, or BOTH!
- ✓ IP66/NEMA4X enclosed with DIGITAL POT **NEW!**



RoHS



* - Chassis models only



153D -E Series



153 -C Series



153D-PB Series



150 Series Features + Specifications

- Dual Voltage 120/240 VAC, 50/60Hz
- Jumper selectable input and output voltage
- ± 10% rated line voltage, 50/60Hz operation
- Adjustable horsepower settings
- Auxiliary heat sink doubles HP rating
- Power and Current Limit on-board LED's
- 1/4" male spade terminal connections standard
- Full wave bridge supply; 1% speed regulation
- Adjustable Minimum speed (0–30% of base)
- Adjustable Maximum speed (60–100% of base)
- Adjustable IR Compensation, Current Limit
- Adjustable linear Accel and Decel (D models)
- -10° to +45°C ambient temperature
- Line voltage compensation
- 5K ohm speed potentiometer kit included
- 50:1 speed range
- Overload capacity: 200% for one minute
- Transient voltage protection

| Model | Width | Length | Depth | Weight |
|--------|----------------------|-----------------------|-----------------------|----------------------|
| 153- C | 3.61 in [9.17 cm] | 4.25 in [10.8 cm] | 1.295 in [3.29 cm] | 0.813 lb [369 gm] |
| 153-E | 5.53 in [14.1 cm] | 7.25 in [18.42 cm] | 2.75 in [6.98 cm] | 17.50 oz [486 gm] |

Options:



-29B

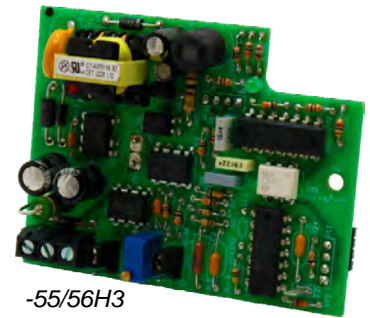

-55/56H3

| Base Model | | | | | | | Options | | | | | |
|-----------------|----------------|---------------|------------|----------|------|------------------|---------|----|--------|------|-------|-------|
| Model* | Supply Voltage | Motor Voltage | DC Current | HP | Body | Speed Pot | -HSK | -T | -F1/F2 | -29B | -55H3 | -56H3 |
| 153D-25C | 120 VAC** | 90VDC** | 2A | 1/50-1/8 | C | Rotary 5K ohm | √ | √ | F | √ | F | F |
| | 240VAC** | 90/180VDC** | | 1/25-1/4 | | | | | | | | |
| 153D-200C | 120 VAC** | 90VDC** | 6A | 1/8-1/2 | C | Rotary 5K ohm | √ | √ | F | √ | F | F |
| | 240VAC** | 90/180VDC** | | 1/4-1 | | | | | | | | |
| 153D-25E | 120 VAC** | 90VDC** | 2A | 1/50-1/8 | E | Rotary 5K ohm | N/A | S | S | N/A | N/A | F |
| | 240VAC** | 90/180VDC** | | 1/25-1/4 | | | | | | | | |
| 153D-25E-29 | 120 VAC** | 90VDC** | 2A | 1/50-1/8 | E | Rotary 5K ohm | N/A | S | S | S | N/A | F |
| | 240VAC** | 90/180VDC** | | 1/25-1/4 | | | | | | | | |
| 153D-200E | 120 VAC** | 90VDC** | 10A | 1/8-1 | E | Rotary 5K ohm | N/A | S | S | N/A | N/A | F |
| | 240VAC** | 90/180VDC** | | 1/4-2*** | | | | | | | | |
| 153D-200E-29 | 120 VAC** | 90VDC** | 10A | 1/8-1 | E | Rotary 5K ohm | N/A | S | S | S | N/A | F |
| | 240VAC** | 90/180VDC** | | 1/4-2*** | | | | | | | | |
| 153D-25E-PB | 120 VAC** | 90VDC** | 2A | 1/50-1/8 | E | Digital | N/A | S | S | N/A | N/A | N/A |
| | 240VAC** | 90/180VDC** | | 1/25-1/4 | | | | | | | | |
| 153D-25E-PB-29 | 120 VAC** | 90VDC** | 2A | 1/50-1/8 | E | Digital | N/A | S | S | S | N/A | N/A |
| | 240VAC** | 90/180VDC** | | 1/25-1/4 | | | | | | | | |
| 153D-200E-PB | 120 VAC** | 90VDC** | 10A | 1/8-1 | E | Digital | N/A | S | S | N/A | N/A | N/A |
| | 240VAC** | 90/180VDC** | | 1/4-2*** | | | | | | | | |
| 153D-200E-PB-29 | 120 VAC** | 90VDC** | 10A | 1/8-1 | E | Digital | N/A | S | S | S | N/A | N/A |
| | 240VAC** | 90/180VDC** | | 1/4-2*** | | | | | | | | |

*D Series models include motor Field supply, ACCEL/DECCEL adjustments, & Power/Current Limit LED's. L series do not.

**Supply and Motor voltages are jumper selectable. Ex: both 120 and 240VAC supply may have 90VDC Motor Voltage Output.

***HP ratings are halved with 90VDC output

C – open chassis

E – NEMA 4X enclosed

PB - Digital Push Button Speed Pot

√ - Option is available

S - Standard Feature

N/A – Option Not available

F – Option is available as Factory Installed only

Option Description:

-HSK: Auxiliary heat sink doubles stated HP rating

-T: Euro style terminal strip in place of space terminals

-F1/F2: one (F1) or two (F2) fuse blocks which may be used to fuse AC line, motor armature, or both.
Fuses not included

-29B: 4PDT center block (no pass) switch. Cuts off supply power while changing motor direction

-55H3: Isolated 0-5 to 0-250VDC / 4-20mA signal follower input

-56H3: Same as -55H3, with provision to add manual speed pot for Auto/Manual operation

125 Series*

LEGACY CONTROL

The 125 Series is a cost effective drive that incorporates up-to-date design and engineering into a compact package. Installation and field adjustments are facilitated using a barrier type terminal strip and large, easily adjusted trimpots. Standard features include an inhibit circuit for start-stop operation and 1% speed regulation over a 50:1 speed range. Long life and quality are assured by 100% full load testing. The 125 Series is ideal for applications such as: office machinery, conveyors, packaging equipment, printers, conveyORIZED tunnels, process equipment, centrifuges, and exercise equipment.

125DV-C





RoHS

*chassis models only



125DV200EW-29-4



The NEMA 4X models were designed to directly replace many legacy models from Fincor, Dayton, Seco and others

125DV200EB-29-4

*The 125 Series has become a Legacy Control. A direct replacement will be the 150 Series.



Dart Controls Distributed by Gross Automation. | +1 (262) 252-1600 or email sales@grossautomation.com.

125 Series Features + Specifications

- Dual Voltage 120/240 VAC or 24/36 VAC, 50/60Hz
- ± 10% rated line voltage
- Adjustable horsepower settings
- Barrier terminal strip
- Full wave bridge supply
- 1% speed regulation
- Adjustable Minimum speed (0–30% of base)
- Adjustable Maximum speed (66–100% of base)
- Adjustable IR Compensation
- Adjustable Current Limit
- Adjustable Linear Acceleration & Deceleration (-2A)
- -10° to +45°C ambient temperature
- Line voltage compensation
- 5K ohm speed potentiometer kit included
- 50:1 speed range
- Overload capacity: 200% for one minute
- Transient voltage protection
- Voltage follower mode - isolated signal (0–10 VDC)
- Inhibit circuit—permits low power start & stop

| Model | Width | Length | Depth | Weight |
|-------------------|-----------------------|-----------------------|-----------------------|---------------------|
| 123D | 3.63 in [9.22 cm] | 4.25 in [10.76 cm] | 1.30 in [3.30 cm] | 12.5 oz [354 gm] |
| 125D / 125DV-C | 3.63 in [9.22 cm] | 4.25 in [10.76 cm] | 1.30 in [3.30 cm] | 12.5 oz [354 gm] |
| 125DV200E | 5.00 in [12.70 cm] | 9.50 in [42.10 cm] | 5.50 in [14.10 cm] | 64 oz [1.81 kg] |

Options:

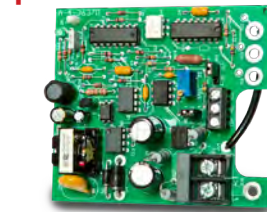

-55H125 option



-2A option

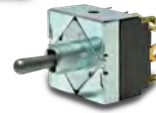

-29B switch option



-HS heat sink option

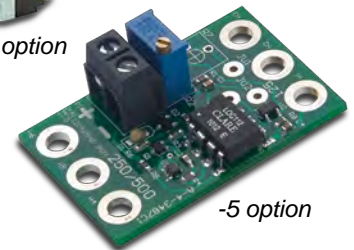

-5 option

| Base Model | | | | | | Options | | | | | | | | | | | |
|--------------------|----------------|---------------|---------|----------|------|---------|-----|-----|-----|-----|-----|-----|-----|------|-----|-----|-----|
| Model | Supply Voltage | Motor Voltage | Current | HP | Body | -HS | -K | -L | -1 | -2A | -4 | -5 | -7 | -15B | -29 | -55 | -56 |
| 123D-C | 24-36 VAC | 24-36 VDC | 5.5 ADC | N/A | C | N/A | N/A | N/A | N/A | ✓ | N/A | ✓ | ✓ | N/A | ✓ | N/A | N/A |
| 125D-12C | 120 VAC | 90 VDC | 1.2 ADC | 1/50-1/8 | C | ✓ | F | F | ✓ | ✓ | N/A | ✓ | ✓ | F | ✓ | ✓ | ✓ |
| | 240 VAC | 180 VDC | | 1/25-1/4 | | | | | | | | | | | | | |
| 125DV-C | 120 VAC | 90 VDC | 5.5 ADC | 1/8-1/2 | C | ✓ | F | F | ✓ | ✓ | N/A | ✓ | ✓ | F | ✓ | ✓ | ✓ |
| | 240 VAC | 180 VDC | | 1/4-1 | | | | | | | | | | | | | |
| 125DV200EB [Black] | 120 VAC | 90 VDC | 10 ADC | 1/8-1 | E | N/A | N/A | F | N/A | S | F | N/A | N/A | N/A | F | N/A | F |
| | 240 VAC | 180 VDC | | 1/4-2 | | | | | | | | | | | | | |
| 125DV200EW [White] | 120 VAC | 90 VDC | 10 ADC | 1/8-1 | E | N/A | N/A | F | N/A | S | F | N/A | N/A | N/A | F | N/A | F |
| | 240 VAC | 180 VDC | | 1/4-2 | | | | | | | | | | | | | |

C – open chassis

E – NEMA 4X enclosed

✓ - Option is available

S - Standard Feature

N/A – Option Not available

F – Option is available as Factory Installed only

Option Description:

- HS: Auxiliary heat sink doubles stated current / HP rating
- K: Fixed Acceleration rate of 6 seconds
- L: UL Listed version (applies to 125DV-C chassis models only. All enclosed models are UL Listed)
- 1: Speed Pot Interlock - when AC power is applied, speed pot must be turned full CCW to start drive
- 2A: Adds linear ACCEL and DECEL adjustment. Already included in Enclosed models
- 4: Jog - momentary switch will jog motor at speed pot setting - enclosed models only
- 5: Isolated 4-20mA signal follower input - loop power NOT provided
- 7: Same as -5 option, with provision to add manual speed pot for Auto/Manual operation
- 15B: Fixed Acceleration rate of 4 seconds
- 29: 4PDT center block (no pass) switch motor reversing. Cuts off supply power while changing motor direction
- 55H125: Isolated 0-5 to 0-250VDC signal follower input
- 56H125: Same as -55H125, with provision to add manual speed pot for Auto/Manual operation

15 Series



The 15 Series is an OEM designer favorite for use with small motors found in a wide variety of applications. Two chassis styles and both NEMA 1 and NEMA 4 enclosed models make the 15 Series an easy choice for your fractional HP application needs. The updated circuit utilizes SMT technology to deliver maximum power density from the smallest possible package, without sacrificing speed range or regulation.

Typical applications include conveyors and material handling, food equipment, dryers and ovens.



15DV1A



15DV2A



15DVE



15DVP

Dart Controls Distributed by Gross Automation. | +1 (262) 252-1600 or email sales@grossautomation.com.



15 Series Features + Specifications

- Dual Voltage 12/24VAC and 120/240 VAC, 50/60Hz
- ± 10% rated line voltage
- Full wave bridge supply
- 1% speed regulation
- Adjustable Minimum speed (0–30% of base)
- Adjustable Maximum speed (66–100% of base)
- Adjustable IR Compensation
- -10° to +45°C ambient temperature
- Line voltage compensation
- 5K ohm speed potentiometer included
- 25:1 speed range
- Overload capacity: 200% for one minute
- Transient voltage protection
- Power On/Off switch (enclosed models)
- AC line fuse (13DVE/15DVE only)

| Model | Width | Length | Depth | Weight |
|-----------|-----------------------|-----------------------|-----------------------|---------------------|
| 13/15DV1A | 2.80 in [7.20 cm] | 3.30 in [8.40 cm] | 1.30 in [3.30 cm] | 2.64 oz [75 gm] |
| 13/15DV2A | 2.80 in [7.20 cm] | 3.30 in [8.40 cm] | 1.50 in [3.90cm] | 2.94 oz [83 gm] |
| 15DVP | 4.17 in [10.59 cm] | 4.96 in [12.60 cm] | 2.73 in [6.93 cm] | 10.4 oz [295 gm] |
| 13/15DVE | 3.81 in [9.68 cm] | 3.50 in [8.89 cm] | 5.50 in [14.10 cm] | 10 oz [264 gm] |

Bracket Orientation:

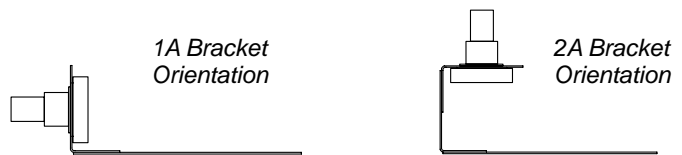

| Base Model | | | | | | Options | |
|------------|----------------|---------------|---------|----------|------|---------|--------------|
| Model | Supply Voltage | Motor Voltage | Current | HP | Body | -TS | -104 |
| 13DV1A | 12 VAC | 12 VDC | 2 ADC | <1/20 | C | ✓ | Call Factory |
| | 24 VAC | 24 VDC | | | | | |
| 13DV2A | 12 VAC | 12 VDC | 2 ADC | <1/20 | C | ✓ | N/A |
| | 24 VAC | 24 VDC | | | | | |
| 13DVE | 12 VAC | 12 VDC | 3 ADC | <1/12 | E4 | N/A | S |
| | 24 VAC | 24 VDC | | | | | |
| 15DV1A | 120 VAC | 90 VDC | 2 ADC | 1/50-1/6 | C | ✓ | ✓ |
| | 240 VAC | 180 VDC | | 1/25-1/3 | | | |
| 15DV2A | 120 VAC | 90 VDC | 2 ADC | 1/50-1/6 | C | ✓ | N/A |
| | 240 VAC | 180 VDC | | 1/25-1/3 | | | |
| 15DVP | 120 VAC | 90 VDC | 2 ADC | 1/50-1/6 | E1 | N/A | S |
| | 240 VAC | 180 VDC | | 1/25-1/3 | | | |
| 15DVE | 120 VAC | 90 VDC | 3 ADC | 1/50-1/4 | E4 | N/A | S |
| | 240 VAC | 180 VDC | | 1/25-1/2 | | | |

C – open chassis

E1 - NEMA 1; E4 - NEMA 4 enclosed

✓ - Option is available

S - Standard Feature

N/A – Option Not available

F – Option is available as Factory Installed only

Option Description:

- TS: Chassis models only - terminal strip to allow for remote installation of speed pot
- 104: “1A” chassis models only - FOR 120VAC SUPPLY applications only - On/Off switch ganged to back of speed pot

130 Series

The 130 Series from Dart is an economical, safe and effective drive for applications which require rapid stopping (brake) or reversal of the motor being controlled. The 130 Series uses relays and sophisticated circuitry to reverse the motor safely - avoiding damage to both the motor and the drive.

The motor should be stopped in its original direction before armature voltage polarity is reversed, to safely achieve direction reversal. The 130 Series accomplishes this automatically. The sequence is to disconnect the motor from the drive and replace it with a dynamic brake resistor - this dissipates all energy in the motor causing the motor to stop fast (brake). Once the 130 circuit sees this has occurred, the relays change state and allow the motor to start in the opposite direction. This happens in a fraction of a second. As many as 30 motor reversals a minute can be executed even with the motor under full load.

In many applications the 130 Series will replace expensive regenerative drives that do not require holding torque for the application.



130L / 132L Series

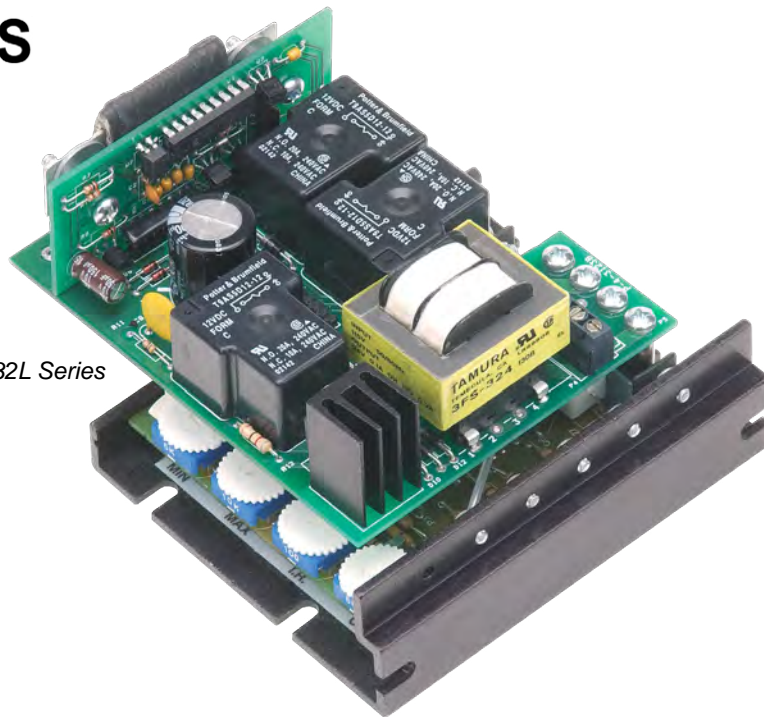

130 Series Features + Specifications

- Two single supply voltage options: 120 & 240 VAC
- Full HP rated - no auxiliary heat sink required
- $\pm 10\%$ rated line voltage, 50/60Hz operation
- Adjustable horsepower settings
- Barrier terminal strip
- Full wave bridge supply; 1% speed regulation
- Adjustable Minimum speed (0–30% of base)
- Adjustable Maximum speed (60–100% of base)
- Adjustable IR Compensation
- Adjustable Current Limit
- -10° to $+45^{\circ}\text{C}$ ambient temperature
- Line voltage compensation
- 5K ohm speed potentiometer kit included
- 50:1 speed range
- Overload capacity: 200% for one minute
- Transient voltage protection
- Voltage follower mode - isolated signal (0–10 VDC)
- Inhibit circuit—permits low power start & stop
- Automatic dynamic brake on power loss
- Available in chassis models only

| Model | Width | Length | Depth | Weight |
|-------------------|-----------------------|-----------------------|-----------------------|---------------------|
| 130/132 LC Series | 4.25 in [10.80 cm] | 5.06 in [12.85 cm] | 2.65 in [6.73 cm] | 1.08 lb [490 gm] |
| 130/132 HC Series | 6.25 in [15.88 cm] | 7.0 in [17.78 cm] | 4.06 in [10.31 cm] | 3.30 lb [1.5 kg] |

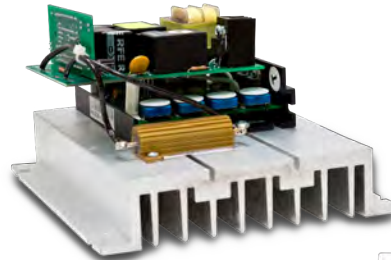

130/132 HC Series



| Base Model | | | | | | |
|------------|----------------|---------------|---------|----------|---------|--------------------|
| Model | Supply Voltage | Motor Voltage | Current | HP | Body | Cycles/min (up to) |
| 130LC12 | 120 VAC | 90 VDC | 1.2 ADC | 1/50-1/8 | Chassis | 3 |
| 130LC100 | 120 VAC | 90 VDC | 5.5 ADC | 1/8-1/2 | Chassis | 3 |
| 130HC12 | 120 VAC | 90 VDC | 1.2 ADC | 1/50-1/8 | Chassis | 30 |
| 130HC100 | 120 VAC | 90 VDC | 10 ADC | 1/8-1 | Chassis | 30 |
| 132LC25 | 240 VAC | 180 VDC | 1.2 ADC | 1/25-1/4 | Chassis | 3 |
| 132LC200 | 240 VAC | 180 VDC | 5.5 ADC | 1/4-1 | Chassis | 3 |
| 132HC200 | 240 VAC | 180 VDC | 10 ADC | 1/4-2 | Chassis | 30 |

Applications:

- Door operators
- Feeders
- Tapping machines
- Spray/brush applicators
- Screen presses
- Powered drawer operators
- Target (shooting) operators
- Antennae operators

253 Series

**TOP
SELLER**

The 253 Series offers superb flexibility, reliability, and value. A general purpose, economical drive rated to 2HP, the 253 Series is our top-selling enclosed drive. Where most other drives require options to include soft start adjustment, AC line fuse protection and additional heat sink to handle higher HP motors, these are all included in every 253G model as standard features. Reliability is enhanced from the use of a rugged packaged power bridge. Chassis or NEMA 4/12 enclosure styles are available. Many options further extend the 253's capabilities.

Typical applications include conveyors and material handling, process pumps and machine tools.



253G-200C

cUL_{us} RoHS



253G-200E-29



253G-200E-7

Dart Controls Distributed by Gross Automation. | +1 (262) 252-1600 or email sales@grossautomation.com.



253 Series Features + Specifications

- Dual Voltage 120/240 VAC, 50/60Hz
- Full HP rated - no auxiliary heat sink required
- $\pm 10\%$ rated line voltage
- Adjustable horsepower settings
- Barrier terminal strip
- Full wave bridge supply
- 1% speed regulation
- Adjustable Minimum speed (0–30% of base)
- Adjustable Maximum speed (66–100% of base)
- Adjustable IR Compensation
- Adjustable Current Limit
- Adjustable Linear Acceleration
- -10° to $+45^\circ\text{C}$ ambient temperature
- Line voltage compensation
- 5K ohm speed potentiometer kit included
- 50:1 speed range
- Overload capacity: 150% for one minute
- Transient voltage protection
- Voltage follower mode - isolated signal (0–12 VDC)
- Inhibit circuit—permits low power start & stop

| Model | Width | Length | Depth | Weight |
|------------------|----------------------|-----------------------|----------------------|----------------------|
| 251/253 chassis | 5.53 in [14.1 cm] | 7.00 in [17.78 cm] | 1.63 in [4.14 cm] | 14.25 oz [404 gm] |
| 251/253 enclosed | 5.53 in [14.1 cm] | 7.25 in [18.42 cm] | 2.75 in [6.98 cm] | 17.50 oz [486 gm] |

Options:

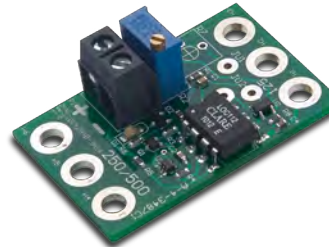

-5 option board

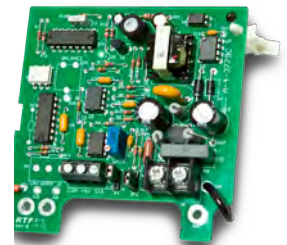

-55H2 option board

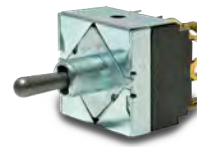

-29B

| Base Model | | | | | | Options | | | | | | | |
|------------|----------------|---------------|---------|----------|------|---------|-----|----|------|-----|------|-------|-------|
| Model | Supply Voltage | Motor Voltage | Current | HP | Body | -4X | -5 | -7 | -17B | -29 | -34A | -55H2 | -56H2 |
| 251G-12C | 120 VAC | 90 VDC | 1.2 ADC | 1/50-1/8 | C | N/A | ✓ | ✓ | F | ✓ | N/A | ✓ | ✓ |
| | 240 VAC | 180 VDC | | 1/25-1/4 | | | | | | | | | |
| 253G-200C | 120 VAC | 90 VDC | 10 ADC | 1/8-1 | C | N/A | ✓ | ✓ | F | ✓ | N/A | ✓ | ✓ |
| | 240 VAC | 180 VDC | | 1/4-2 | | | | | | | | | |
| 251G-12E | 120 VAC | 90 VDC | 1.2 ADC | 1/50-1/8 | E | F | N/A | ✓ | F | F | F | N/A | F |
| | 240 VAC | 180 VDC | | 1/25-1/4 | | | | | | | | | |
| 253G-200E | 120 VAC | 90 VDC | 10 ADC | 1/8-1 | E | F | N/A | ✓ | F | F | F | N/A | F |
| | 240 VAC | 180 VDC | | 1/4-2 | | | | | | | | | |

C – open chassis

E – NEMA 4 enclosed

✓ - Option is available

S - Standard Feature

N/A – Option Not available

F – Option is available as Factory Installed only

Option Description:

- 4X: NEMA 4X wash down rated - enclosed models only
- 5: Isolated 4-20mA signal follower input - loop power NOT provided
- 7: Same as -5 option, with provision to add manual speed pot for Auto/Manual operation
- 17B: Adjustable Acceleration rate = Deceleration rate
- 29: 4PDT center block (no pass) switch motor reversing. Cuts off supply power while changing motor direction
- 34A: Torque Control (enclosed models only) - changes speed pot to Torque adjustment
- 55H2: Isolated 0-5 to 0-250VDC signal follower input
- 56H2: Same as -55H2, with provision to add manual speed pot for Auto/Manual operation

530 Series

The 530 Series is Dart's top of the line, feature packed drive. Rated up to 3HP, this drive offers all the features typically needed in an SCR drive application. The 530 Series control combines advanced engineering design, premium component selection and rigorous quality control to deliver an excellent off-the-shelf SCR drive. Dependable, time-proven circuitry offers performance characteristics previously available only in more costly drives.

While providing a wide range of standard features, many options quickly and easily extend the 530 Series' capabilities to meet specific application requirements. An integral part of a distinguished line of quality products, the 530 Series is representative of Dart's continuing effort to provide reliable, versatile drives to the OEM, distributor, and industrial markets.

cUL[®] US **RoHS**



530BRE



530BRC



530 Series Features + Specifications

- Dual Voltage 120/240 VAC, 50/60Hz
- Full HP rated - no auxiliary heat sink required
- ± 10% rated line voltage
- Adjustable horsepower settings
- Barrier terminal strip
- Full wave bridge supply; 1% speed regulation
- Adjustable Minimum speed (0–30% of base)
- Adjustable Maximum speed (60–120% of base)
- Adjustable IR Compensation
- Adjustable Current Limit
- Adjustable Linear Acceleration and Deceleration
- On-board power interrupt relay (RC and RE versions)
- Solid state over-current output
- -10° to +45°C ambient temperature
- Line voltage compensation
- 5K ohm speed potentiometer kit included
- 50:1 speed range
- Overload capacity: 200% for one minute
- Transient voltage protection
- Voltage follower mode - isolated signal (0–12 VDC)
- Inhibit circuit—permits low power start & stop

| Model | Width | Length | Depth | Weight |
|--------------|-----------------------|-----------------------|-----------------------|----------------------|
| 530 enclosed | 6.70 in [17.02 cm] | 10.0 in [25.40 cm] | 4.75 in [12.07 cm] | 56.0 oz [1.42 kg] |
| 530 chassis | 6.70 in [17.02 cm] | 9.00 in [22.86 cm] | 2.00 in [5.08 cm] | 40.0 oz [1.13 kg] |

Options:

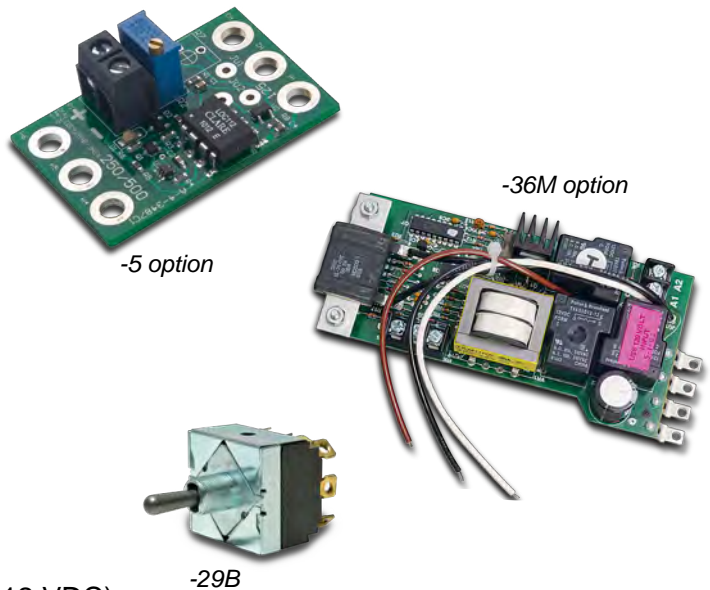

| Base Model | | | | | | Options | | | | | | | | | |
|------------|----------------|---------------|---------|-------|------|---------|-----|-----|------|------|------|-------|------|-------|--|
| Model | Supply Voltage | Motor Voltage | Current | HP | Body | -4 | -5 | -7 | -15A | -29B | -36M | -36MA | -38M | -38MA | |
| 530BC | 120 VAC | 90 VDC | 10 ADC | 1/8-1 | C | N/A | ✓ | ✓ | F | ✓ | F | F | F | F | |
| | 240 VAC | 180 VDC | | 1/4-2 | | | | | | | | | | | |
| 530BRC | 120 VAC | 90 VDC | 10 ADC | 1/8-1 | C | N/A | ✓ | ✓ | F | ✓ | F | F | F | F | |
| | 240 VAC | 180 VDC | | 1/4-2 | | | | | | | | | | | |
| 533BC | 120 VAC | 90 VDC | 15 ADC | 1.5 | C | N/A | ✓ | N/A | N/A | N/A | N/A | N/A | N/A | N/A | |
| | 240 VAC | 180 VDC | | 3.0 | | | | | | | | | | | |
| 530BRE | 120 VAC | 90 VDC | 10 ADC | 1/8-1 | E | F | N/A | F | F | ✓ | F | F | F | F | |
| | 240 VAC | 180 VDC | | 1/4-2 | | | | | | | | | | | |

C – open chassis

E – NEMA 4 enclosed

✓ - Option is available

F – Option is available as Factory Installed only

N/A – Option Not available

Option Description:

- 4: Run/Jog feature- enclosed models only
- 5: Isolated 4-20mA signal follower input - loop power NOT provided
- 7: Same as -5 option, with provision to add manual speed pot for Auto/Manual operation
- 15A: Extended linear Acceleration & Deceleration to 30 seconds
- 29B: 4PDT center block (no pass) switch motor reversing. Cuts off supply power while changing motor direction
- 36M: Anti-plug/zero speed detect relay reverse with dynamic brake. Renders main drive to single voltage (120VAC/90VDC)
- 36MA: Same as -36M, with heavy duty dynamic brake resistor. For high cycle / high inertia load \ applications
- 38M: Same as -36M except renders main drive to single voltage (240VAC/180VDC)
- 38MA: Same as -38M, with heavy duty dynamic brake resistor. For high cycle / high inertia load applications

Signal Follower and Serial Interface Options

In many applications it is a requirement that the Dart product being used be interfaced with a supervisory control – plc/micro-controller/computer/HMI. Most applications involve a traditional analog signal sent to the control to set motor speed, and turn the control on or off. More and more we are seeing the need for serial interface over a network – Dart has responded with our Modbus serial interface for the 150 Series. The following details follower/interface options Dart offers and which controls they may be used with in the Analog SCR Drive group.

-5/-7 4-20mA Follower

This is an optically isolated 4-20mA signal follower. It installs on the speed pot terminals of the control. The -5 is a pure signal follower that takes the place of the traditional manual speed pot. The -7 is similar but adds the ability to either control with a local speed pot in Manual mode, or follow the 4-20mA signal in Automatic mode. For models 123D, 125D, 251G, 253G, 130, 132 and 530B

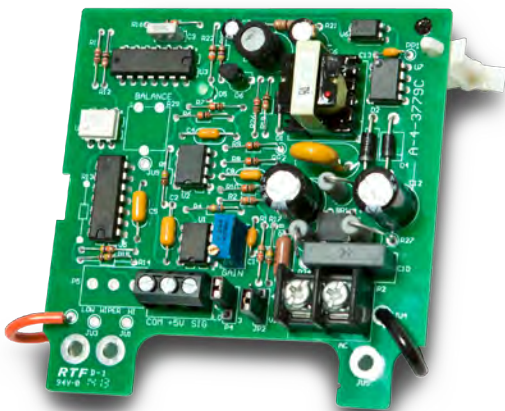
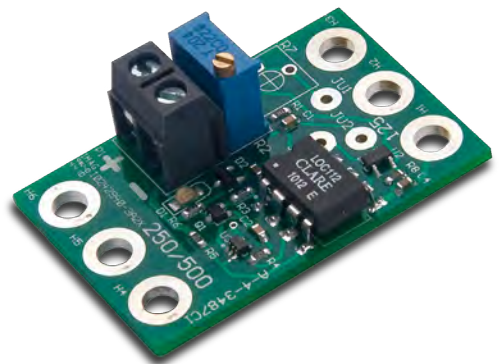

-55H2/-56H2 Voltage and 4-20mA Follower

This is an optically isolated signal follower for signals in the 0-5 to 0-250VDC range. It will also accept 4-20mA signal. The -55H2 is a pure signal follower that takes the place of the traditional manual speed pot. The -56H2 is similar but adds the ability to either control with a local speed pot in Manual mode, or follow the remote signal in Automatic mode. For models 123D, 125D, 153L/D, 251G, and 253G

| Send to Drive | Read From Drive |
|-----------------------------------|---------------------------------------|
| Motor Set Speed | Motor Actual Speed (encoder required) |
| Drive Accel Rate | Drive Fault Status |
| Inhibit Drive Output (stop motor) | Drive Ambient Temperature |
| Power-Up Preset Speed | Drive In Current Limit |

Digital SCR Drives

Dart Controls is the exclusive provider of Digital DC drives to the market. The Dart MicroDrive is a microprocessor-based closed loop DC SCR drives offering an integrated, programmable digital display.

Originally developed for the conveyor pizza oven, MicroDrives have found broad application across many industries. Of particular value to the OEM designer / plant operator is the integrated drive, display, and logic controller functionality all in one unit.

The MicroDrive comes in two styles depending on the application - the **MD Series** (for continuous applications) and the **MD Plus Series** (for start/stop or applications requiring rapid drive response time).

The programmable display is of particular value to the machine/ process operator, providing drive speed information in meaningful engineering units (GPM, FPM, MM:SS, % of Master, etc.)

Both the MD and the MD Plus Series come in panel mount and stand alone enclosed versions. Each may be configured in three modes - Rate, Time and Follower. Follower mode allows for two or more motors to operate at speeds in proportion to each other - a common need in blending, batch and synchronized material feed and handling applications. Many times the logic controller functionality built into the MicroDrive can eliminate the need for a PLC and its custom programming.

The MD Plus offers the additional benefit of a velocity loop PID control algorithm; 4-20mA process signal follower and industrial serial communication. Development will continue on the MD Plus to offer additional serial communication protocols, additional program management tools and a Graphic User Interface (GUI) for both configuration and control.

The Dart MicroDrive is a prime example of how a customer need evolved into a successful, innovative drive product.



MD50E



MD50P



MD10P



PU-E Series

Performance-matched for use with the MD Series



Commutrol™ Series DC Brushless Drives

For over 25 years, Dart Controls has been producing standard off-the-shelf, field-proven DC brushless drives for many industries, including medical equipment, conveyor ovens and solar applications. Whether quiet operation, brush maintenance or long life is a critical application requirement, Dart has the right drive - right now.

While brushless DC (BLDC) technology has been around for decades, the most significant change has been the reduced cost of both motors and drives, driven by increased volume. This makes BLDC a viable consideration for the OEM designer as the benefits of BLDC outweigh the (now) minimal cost premium in many cases.

The benefits of BLDC technology include:

- Quiet motor operation
- Contactor-less motor reversing and braking
- Long life expectancy for drive and motor
- High efficiency operation - low power loss
- Proven design - first choice for tough applications

The Commutrol Series is offered in a variety of supply voltage and current (Watt) ratings - some models as high as 1000W. The 700BDC/710ADC/730BDC Series come in both chassis (standard), NEMA 4/4X enclosed styles. The BLM Series is a panel mount design similar to our Digital DC drives. All models include the choice of open or closed loop regulation (no separate speed sensor required!)

All Commutrol Series models are designed for motors with Hall sensors included.

RoHS



*700BDC / 710ADC
Series*



730 BDC Series



BLM Series

Commutrol™ Series Features + Specifications

Dart Controls Distributed by Gross Automation. | +1 (262) 252-1600 or email sales@grossautomation.com.

- 12-48VDC voltage supply
 - Open or closed loop models
 - Quiet operation - high frequency switching
 - No encoder required for closed loop models
 - ±1/2% base speed regulation (closed loop models)
 - Barrier terminal strip
 - For 'sensored' brushless DC motors (60° or 120°)
 - Contactor-less reversing
 - Some models include dynamic brake*
 - Motor Hall sensor voltage supply included
 - Ships with 5KΩ speed pot kit
 - Low power Inhibit circuit for motor start/stop
 - Run/stop output*, Supply Voltage and Fault LED's*
 - -10° to +45°C ambient temperature
 - Overload capacity: 150-200% for one minute*
 - Inhibit circuit—permits low power start & stop
- * Model dependent - see Operator Manual for details

| Model | Width | Length | Depth | Weight |
|-------------------|----------------------|-----------------------|----------------------|-------------------|
| 700BDC/ 730BDC | 3.62 in [9.19 cm] | 4.25 in [10.80 cm] | 1.30 in [3.30 cm] | 6 oz [170 gm] |
| 731BDC/ 733BDC | 3.62 in [9.19 cm] | 4.25 in [10.80 cm] | 1.30 in [3.30 cm] | 6 oz [170 gm] |
| 710ADC/ 711ADC | 3.62 in [9.19 cm] | 7.00 in [17.78 cm] | 2.00 in [5.08 cm] | 16 oz [453 gm] |
| BLM ¹ | 3.62 in [9.19 cm] | 4.63 in [11.76 cm] | 1.66 in [4.22 cm] | 20 oz [567 gm] |

1- Front bezel is 4.54 x 2.29 in.

| Base Model | | | | | | | Options | | | |
|------------|----------------|---------------|---------|-------------|------------|------|---------|---------|--------|------|
| Model | Supply Voltage | Motor Voltage | Current | Closed Loop | Isolation* | Body | -CL | BLMKIT1 | OPT420 | -HSK |
| 700BDC | 12-36 VDC | 12-36 VDC | 5 ADC | No | No | C | N/A | N/A | N/A | ✓ |
| 730BDC | 12-48 VDC | 12-48 VDC | 7.5 ADC | No | No | C | N/A | N/A | N/A | ✓ |
| 731BDC | 12-48 VDC | 12-48 VDC | 7.5 ADC | Yes | No | C | N/A | N/A | N/A | ✓ |
| 733BDC | 12-48 VDC | 12-48 VDC | 7.5 ADC | Yes | No | C | F | N/A | N/A | ✓ |
| 710ADC | 12-48 VDC | 12-48 VDC | 20 ADC | No | No | C | N/A | N/A | N/A | N/A |
| 711ADC | 12-48 VDC | 12-48 VDC | 20 ADC | Yes | No | C | N/A | N/A | N/A | N/A |
| BLM701P | 12-48 VDC | 12-48 VDC | 8 ADC | Yes | No | P | ✓ | ✓ | ✓ | N/A |

C – Chassis

P - Panel Mount

✓ - Option is available

N/A – Option Not available

E – NEMA 4 enclosed

* Non-isolated follower voltage may be used

F – Option is available as Factory Installed only

Option Description:

-CL: Current Limit shutdown

BLMKIT1: Mating connector and pigtail leads (BLM has plug-style connector only)

OPT420: 4-20mA isolated input/output card. Factory or field installed (as OPT420).

Does NOT supply current loop power

-HSK: Auxiliary heat sink - increases 700BDC to 7ADC continuous and 730BDC Series to 9ADC continuous

Low Voltage DC PWM Drives

The 65 Series from Dart are high performance PWM drives for low voltage DC motors. Used many times in applications with battery voltage as the supply the PWM drive saves energy, increasing time between charges plus extends the overall life of the battery. The 65 Series are also used with low voltage power supply (typically 12-24VDC) due to the size of the motor being used.

Available in four continuous current ratings, the 65 Series maximizes power density in a small footprint. In particular, the 65E10 and 65E20 models have been significantly upgraded to further improve their power efficiency and add features frequently needed in portable equipment and solar powered applications. In addition we have introduced a new NEMA 4X enclosed drive rated up to 20A at 48VDC.

Driven by customer feedback, here are some of the new features we have added to selected (10A and 20A) models:

- 12-48 VDC supply voltage range from same drive
- Up to 1000 Watts power handling in a 3.6" x 4.3" footprint
- Up to 60% lower voltage drop across the drive
- High switching frequency for quiet operation
- LED's - Supply Voltage and Current Limit
- Current Limit output
- Current Limit drive shutdown (option)
- Under (supply) Voltage drive shutdown (option)
- NEMA 4X enclosed models

The 65 Series are used in a wide variety of applications including portable equipment, AGV's, portable conveyors, ag equipment, truck mounted spreaders and sprayers, and many more. Call us today to find out more about this and other products from Dart!

RoHS



65E60 / 65E40 Series



65E10 / 20C Series



65E10 / 20E Series
Enclosed



65 Series Features + Specifications

- Low (12-48Vdc) voltage supply
- Chassis and enclosed models
- Quiet operation - high frequency switching (65E10 & 20)
- Barrier terminal strip
- Adjustable Minimum speed (0-30% of base)
- Adjustable Maximum speed (50-100% of base)
- Adjustable IR Compensation (speed regulation)
- Adjustable Current Limit (to 200% of continuous rating)
- Adjustable Acceleration (0-10 seconds)
- Ships with 5K Ω speed pot kit
- Low power Inhibit circuit for motor start/stop
- 1% base speed regulation over 30:1 speed range
- -10° to +45°C ambient temperature
- Overload capacity: 150% for one minute
- Inhibit circuit—permits low power start & stop
- Current fold-back at 80°C heat sink temp (65E40 & 60)

| Model | Width | Length | Depth | Weight |
|--------------------|-----------------------|-----------------------|-----------------------|---------------------|
| 65E10C/ 65E20C | 3.62 in [9.19 cm] | 4.25 in [10.80 cm] | 1.30 in [3.30 cm] | 6 oz [170 gm] |
| 65E40/ 65E40-12 | 3.70 in [9.40 cm] | 7.00 in [17.78 cm] | 1.70 in [4.32 cm] | 13.4 oz [297 gm] |
| 65E60/ 65E60-12 | 6.70 in [17.02 cm] | 9.00 in [22.86 cm] | 2.27 in [5.77 cm] | 34 oz [962 gm] |
| 65E10E/ 65E20E | 5.53 in [14.00 cm] | 7.30 in [18.50 cm] | 4.78 in [12.10 cm] | 40 oz [1.13 kg] |

| Base Model | | | | | | | | Options |
|-------------|----------------|---------------|---------|----------------------------|------------------------|----------------------|------|---------|
| Model | Supply Voltage | Motor Voltage | Current | Power/ Current Limit LED's | Current Limit Shutdown | Current Limit Output | Body | -LED |
| 65E10C | 12-48 VDC | 12-48 VDC | 10 ADC | Yes | Yes | Yes | C | F |
| 65E10E | 12-48 VDC | 12-48 VDC | 10 ADC | Yes | Yes | Yes | E | STD |
| 65E15E-29** | 12-24 VDC | 12-24 VDC | 15 ADC | Yes | Yes | Yes | E | STD |
| 65E20C | 12-48 VDC | 12-48 VDC | 20 ADC | Yes | Yes | Yes | C | F |
| 65E20E | 12-48 VDC | 12-48 VDC | 20 ADC | Yes | Yes | Yes | E | STD |
| 65E40-12 | 12 VDC | 12 VDC | 40 ADC | No | No | No | C | N/A |
| 65E40 | 24-36 VDC | 24-36 VDC | 40 ADC | No | No | No | C | N/A |
| 65E60-12 | 12 VDC | 12 VDC | 60 ADC | No | No | No | C | N/A |
| 65E60 | 24-36 VDC | 24-36 VDC | 60 ADC | No | No | No | C | N/A |

C – Chassis

E – NEMA 4 enclosed

STD - Standard Feature

F – Option is available as Factory Installed only

N/A – Option Not available

Option Description:

-LED: Chassis model support for driving external customer supplied LED's for Supply Voltage and Current Limit

** : The -29 is a covered mounted FWD/Off/REV switch

Speed Sensors

Dart Controls offers a variety of speed sensor products not only for use with drives and tachometers that require them, but for many other applications as well. The PU Series is designed and built by Dart - the other offerings are from manufacturers built to Dart's specifications.

The PU Series is very popular for its simplicity, efficiency and rugged design. Installation is simple - drill and tap a target shaft and you're done. Dirty, dusty, wet (wash down), and extreme outdoor conditions are not an issue for the PU Series. With the PU-E Series (indoor) and PU-R Series (outdoor / wash down), the user can find the right sensor for the application. The PU Series is sold worldwide on a wide variety of applications where reliable and cost-effective speed sensing is needed.

For applications where location of an accessible shaft is difficult or more pulses/revolution are needed, Dart also offers a variety of sensors that rely on different sensing technologies. These include the CF Series (hall-effect motor C-face mount and the OPU (optical).

With this sensor lineup, customers are able to monitor actual motor speed, verify motor rotation and determine location of motor driven devices such as spray application heads and material handling system carriers. Signals are fed to closed loop motor drives (MD/ASP Series from Dart), plc's and SCADA systems.



PU-E Series



PU-R Series



CF Series

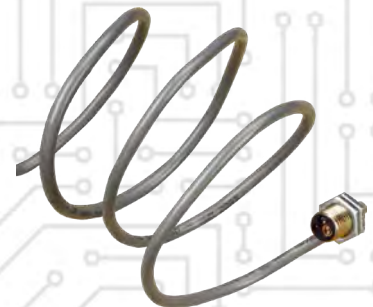

OPU Series

RoHS

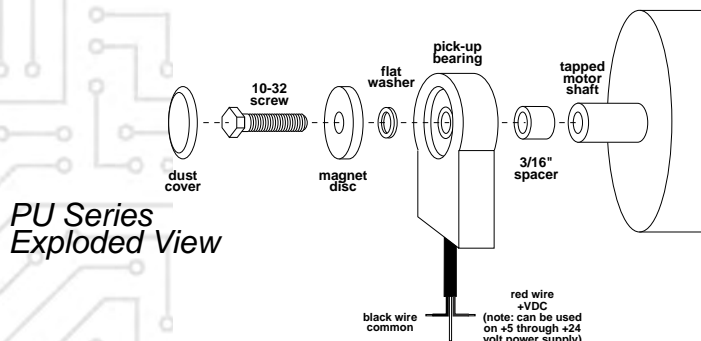

Sensor Features + Specifications

PU Series

- Single screw installation - no alignment needed
- For shaft speeds up to 5000 RPM
- 6' cable provided - may be extended to 300'^{*}
- Supply voltage +4.5 to +30VDC (see below)
- 1 to 20 pulse/revolution output
- NPN output - NPN sinks 50mA max (see below)
- -40°C to +100°C ambient temperature range
- Indoor and outdoor/wash down rated models
- Santoprene injection molded head

CF Series

- Kit consists of motor face ring, mounting hardware and sensing disk (shaft mount)
- Sensing disk impervious to dust, oil and water
- Supply voltage +4.5 to +24VDC
- -40° to +125°C ambient temperature range
- NPN open collector output sinks 20mA max

OPU

- Senses rotation using reflective target
- 3-wire sensor produces square wave output
- NPN open collector output sinks 50mA max
- Output rise/fall: 500nS max.; 600,000 PPM max
- Supply voltage +5 to +6VDC
- 0°C to +70° ambient temperature range

^{*} See Application Note at www.dartcontrols.com

| Model | Width | Length | Depth | Weight |
|------------------|-----------------------------|-----------------------|----------------------|---------------------|
| PU Series (head) | 1.60 in [4.06 cm] | 2.40 in [6.10 cm] | 0.93 in [2.36 cm] | 8.8 oz [249 gm] |
| CF Series | [Std. C Face ¹] | 9.38 in [23.83 cm] | 0.75 in [1.91 cm] | 2.65 lb [1.2 kg] |
| OPU | 0.50 in [1.27 cm] | 0.75 in [1.91 cm] | N/A | 6 oz [170 gm] |

1 – Sizes compatible with 56C, 143TC, 154TC, 182C and 184C face dimensions

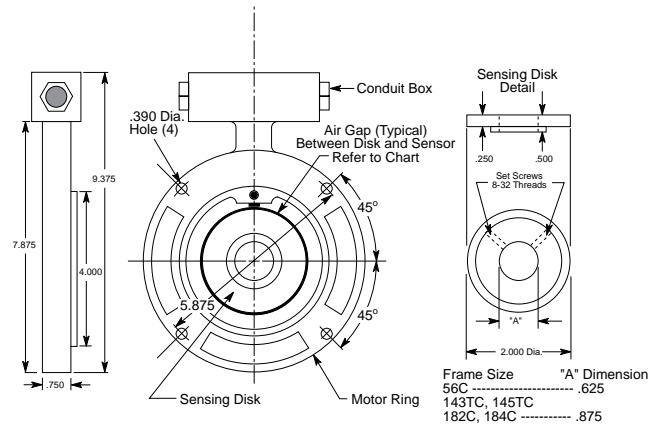

CF Series

| Base Model | | | | |
|--------------------|---------------|------------------|---------------|--------------------------|
| Indoor Model (NPN) | Outdoor Model | Pulse/Rev Output | Cable | Frame Size |
| PU-2E | PU-2R | 1 | Rubber Jacket | N/A |
| PU-4E | PU-4R | 2 | Rubber Jacket | N/A |
| PU-20E | PU-20R | 10 | Rubber Jacket | N/A |
| PU-40E | PU-40R | 20 | Rubber Jacket | N/A |
| CF-H1 | N/A | 1 | N/A | 56C |
| CF-H2 | N/A | 2 | N/A | 56C |
| CF-H15 | N/A | 15 | N/A | 56C |
| CF-H60 | N/A | 60 | N/A | 56C |
| CF-J2 | N/A | 2 | N/A | 143TC, 145TC, 182C, 184C |
| CF-J60 | N/A | 60 | N/A | 143TC, 145TC, 182C, 184C |
| OPU | N/A | Target Dependent | Shielded | N/A |

N/A – Not available

Additional Products

The DM8000 is an economical microprocessor-based digital tachometer system capable of measuring shaft speeds lower than 1 RPM. The display is field programmable via the easy-to-use front panel interface. Large 1/2 inch 4-digit LED

display numbers allow viewing under the most adverse conditions. The DM8000 is actually four devices in one:

- Tachometer • Counter • Totalizer • Zero Speed Switch

The isolated 5 Amp form C relay output may be configured for many alarm, preset count and logic conditions. A single device may be shared by two speed inputs and the displayed toggled - saving cost and space.

For more information visit:

<http://www.dartcontrols.com/product-guide/programmable-tachometers/>



DM8000

The VSI2 provides isolation and signal conversion for applications where drives are connected to supervisory systems such as plc's and SCADA's. The VSI2 offers both analog voltage (+5 to +250VDC) and current (4-20mA) signal input capability. These inputs are scaled and sent to the speed pot circuit on any drive that accepts a 3-wire speed pot input.



VSI2

RoHS

Dart Controls Inc.
5000 W. 106th Street
Zionsville, Indiana 46077



Dart Delivers What You Want... When You Need It!



Since 1963, Dart Controls has been designing and manufacturing variable speed drives, controls, and accessories for electric motors in our Zionsville, Indiana facility.

Our Mission is to lead the market in development of technologically advanced variable speed motor controls and accessory products while maintaining our commitment to customers, employees and owners.

Our Passion is to develop or make available for sale the broadest range of products possible to meet customer's variable speed drive and

motor requirements. We listen to customers and when needed, we will modify existing or add a new design to our product offering. We also leverage our industry relationships to make available for sale related products (AC drives, motors and gear reducers for example) from manufacturers who share our passion for excellence and value.

This Total Solutions Provider approach allows us to deliver Total Value to our customers.

**DART DELIVERS!
PUT US TO THE TEST.**

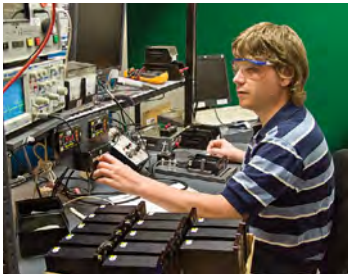

motors in our Zionsville, Indiana facility.

Our Mission is to lead the market in development of technologically advanced variable

speed motor controls and accessory products while maintaining our commitment to customers, employees and owners.

Our Passion is to develop or make available for sale the broadest range of products possible to meet customer's variable speed drive and

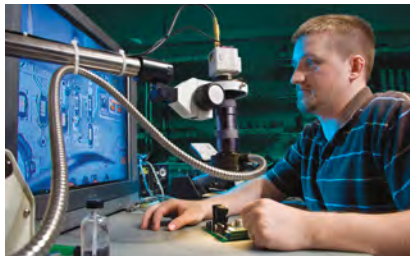

All information contained in this catalog is intended to be correct, however information and data in this catalog are subject to change without notice. Dart Controls, Inc. (DCI) makes no warranty of any kind with regard to this information or data. Further, DCI is not responsible for any omissions or errors or consequential damage caused by the user of the product. DCI reserves the right to make manufacturing changes which may not be included in this catalog.



For the Catalog in .pdf

5000 W. 106th Street, Zionsville, Indiana 46077
Phone: (317) 873-5211 FAX: (317) 873-1105

www.dartcontrols.com
ISO 9001 RoHS Compliant



Dart Controls Distributed by Gross Automation. | +1 (262) 252-1600 or email sales@grossautomation.com.