









Better. By Design.

TIME DELAY RELAYS



CATALOG OF PRODUCTS









PRODUCT SELECTION

Product Series	Refer to:	Time Delay Setting & Ranges	Functions	Input Voltages	Output	Mounting	
	TH4 Series Relay Output	Pages 4-10	Analog-Set 0.05 Seconds to 100 Hours	Single-Function	240V AC/DC, 120V AC/DC, 48V AC/DC, 12V DC, 24V AC/DC	30A SPDT Relay	2" x 3" Encapsulated, Panel Mounted with One Screw
	THR-1 Series Relay Output	Pages 11-17	Analog-Set 0.1 Seconds - 100 Hours	Single-Function	12VDC, 24VAC/DC, 120VAC/DC, 240VAC	10A SPDT Relay	2" x 2" Encapsulated, Panel Mounted with One Screw
	THR-3 Relay Output	Pages 18-19	Analog-Set 0.1 Seconds - 100 Minutes	Multi-Function (4)	24-240VAC, 12-125VDC	10A SPDT Relay	
	THS-1 Series Solid State Output	Pages 20-23	Analog-Set 0.01 Seconds - 100 Hours	Single-Function	24-240VAC, 12-48VDC	1A SPNO Solid State	
	THL-1 Series Solid State Inline (Series) Output	Pages 24-25	Analog-Set 0.01 Seconds - 100 Hours	Single-Function	24-240VAC & 12-48VDC	1A SPNO Solid State	
	THL-8 Series Solid State Inline (Series) Output	Pages 26-27	Digital-Set 0.1 Seconds - 10,230 Seconds	Single-Function	24-240VAC & 12-48VDC	1A SPNO Solid State	

CONTINUED ON NEXT PAGE

TIME DELAY RELAYS

PRODUCT SELECTION

Product Series	Refer to:	Time Delay Setting & Ranges	Functions	Input Voltages	Output	Mounting	
	TR-5 Series Standard	Pages 28-31	Analog-Set 0.05 Seconds - 2 Hours	Single-Function	12VDC, 24VAC/DC, 120VAC/DC, 240VAC	10A DPDT 10A SPDT Relay	Plug-in Utilizing Industry-Standard 8 & 11 Pin Sockets
	TR-6 Series Time Ranger Programmable	Pages 32-39	Analog-Set Multi-Range 0.05 Seconds - 100 Hours	Multi-Function	24-240VAC & 12-125VDC	10A DPDT Relay	
	TD-7 Series Time Ranger Digital-Set Programmable	Pages 40-42	Digital-Set Multi-Range 0.05 Seconds - 999 Hours	Multi-Function (10) & Single-Function	12VAC/DC, 24VAC/DC, 120VAC/DC, 240VAC	10A DPDT 10A SPDT Relay	
	TD-8 Series Time Ranger Digital-Set Programmable	Pages 43-45	Digital-Set Multi-Range 0.1 Seconds - 1,023 Hours	Multi-Function (16) & Single-Function	12VAC/DC, 24VAC/DC, 120VAC/DC, 240VAC	10A DPDT 10A SPDT Relay	
	TAD Series Digital-Set 1/16 DIN	Pages 46-47	Digital-Set Multi-Range 0.01 Seconds - 9,990 Hours	Multi-Function (10)	24-240VAC & 24-240VDC	5A SPDT Relay	1/16 DIN (48mm ²)
	TAA Series Analog-Set 1/16 DIN	Pages 48-49	Analog-Set Multi-Range 0.05 Seconds - 100 Hours	Multi-Function (6)-2 Versions	100-240VAC & 24-240VDC	5A DPDT & SPDT Timed & SPDT Instantaneous Relay	
	TE-881 Series Programmable	Pages 50-51	Analog-Set 0.1 Seconds - 10 Days	Multi-Function (10)	12-240V AC/DC	15A SPDT & DPDT Relay	17.5mm
	TE-6 Series Programmable	Pages 52-54	Analog-Set 0.1 Seconds - 100 Hours	Single Function	12-240V AC/DC	10A SPDT Relay	17.5mm
	TE5 Series	Pages 55-56	Analog-Set 0.1 Seconds - 100 Hours	Multi-Function (15)	24-240V AC & 12-24V DC	10A DPDT 10A SPDT Relay	17.5mm

TIME DELAY RELAYS

ON DELAY, INTERVAL, FLASHER, CYCLE & DELAYED INTERVAL

RELAY OUTPUT | TH4 SERIES | HIGH AMP

ISOLATED RELAY COMMON



- ◆ Effectively and economically operate heavy loads
- ◆ 30A SPDT relay output contacts can control loads without a separate contactor
- ◆ Cost effective design and compact 2" x 3" enclosure are ideal for volume OEM applications
- ◆ Microprocessor-based for superior accuracy and repeatability
- ◆ Encapsulated for resistance to harsh environments
- ◆ Time delays are set using adjustable on-board potentiometers, remote potentiometers, or they can be factory fixed.
- ◆ Time ranges from 0.05 seconds to 100 hours.



Better. By Design.

800.238.7474
WWW.MACROMATIC.COM
SALES@MACROMATIC.COM

FUNCTION ■	CONTROL VOLTAGE	CATALOG NUMBER **	WIRING
ON DELAY	240V AC/DC 120V AC/DC 48V AC/DC 12V DC 24V AC/DC	TH40261-** TH40262-** TH40264-** TH40266-** TH40268-**	<p>DIAGRAM 374</p> <p>Remote Adjustable Time Delay (R1 Modification)</p>
INTERVAL ON	240V AC/DC 120V AC/DC 48V AC/DC 12V DC 24V AC/DC	TH40561-** TH40562-** TH40564-** TH40566-** TH40568-**	
FLASHER (OFF Time 1st)	240V AC/DC 120V AC/DC 48V AC/DC 12V DC 24V AC/DC	TH40861-** TH40862-** TH40864-** TH40866-** TH40868-**	
FLASHER (ON Time 1st)	240V AC/DC 120V AC/DC 48V AC/DC 12V DC 24V AC/DC	TH40961-** TH40962-** TH40964-** TH40966-** TH40968-**	
REPEAT CYCLE * (OFF Time 1st)	240V AC/DC 120V AC/DC 48V AC/DC 12V DC 24V AC/DC	TH43161-** TH43162-** TH43164-** TH43166-** TH43168-**	
REPEAT CYCLE * (ON Time 1st)	240V AC/DC 120V AC/DC 48V AC/DC 12V DC 24V AC/DC	TH45161-** TH45162-** TH45164-** TH45166-** TH45168-**	
DELAYED * INTERVAL	240V AC/DC 120V AC/DC 48V AC/DC 12V DC 24V AC/DC	TH46161-** TH46162-** TH46164-** TH46166-** TH46168-**	<p>DIAGRAM 380</p>

■ See "Definitions of Timing Functions" at back of catalog.

** Complete Product Number using two-digit Code from Time Range Table below.

TIME DELAY OPTIONS

● Onboard Adjustable Time Delay

Complete product number by adding two-digit code from table at right. For example, TH40262-30 is an On Delay with a time delay range of 0.1-10 seconds).

* Dual Time functions come with matching time ranges as standard. See www.macromatic.com/onoff for how to order a unit with non-matching combinations.

● Onboard Fixed Time Delay

Replace two-digit code with suffix "F" followed by delay [0.1 ... 100] followed by (S) seconds, (M) minutes or (H) hours. For example, TH40262-F5S is an On Delay with a time delay fixed at 5 seconds.

● Remote Adjustable Time Delay (R1 Modification)

Single Time function models can be built with two terminals for remote adjustable or fixed time delays.

** TIME RANGE TABLE	
Time Delay Range	Code
0.05 - 5 seconds	04
0.1 - 10 seconds	30
0.3 - 30 seconds	07
0.6 - 60 seconds	08
1 - 100 seconds	31
1.2 - 120 seconds	09
1.8 - 180 seconds	10
3 - 300 seconds	12
10 - 1,000 seconds	36
0.1 - 10 minutes	32
0.3 - 30 minutes	15
0.6 - 60 minutes	16
1 - 100 minutes	33
10 - 1,000 minutes	37
0.02 - 2 hours	17
0.1 - 10 hours	34
1 - 100 hours	35

ON DELAY, INTERVAL, FLASHER, CYCLE & DELAYED INTERVAL

RELAY OUTPUT | TH4 SERIES | HIGH AMP

CONTROL VOLTAGE CONNECTED AT RELAY COMMON

FUNCTION ■	CONTROL VOLTAGE	CATALOG NUMBER **	WIRING
ON DELAY	240V AC/DC 120V AC/DC 48V AC/DC 12V DC 24V AC/DC	TH40261-**J TH40262-**J TH40264-**J TH40266-**J TH40268-**J	<p>DIAGRAM 375</p> <p>Remote Adjustable Time Delay (R1 Modification)</p>
INTERVAL ON	240V AC/DC 120V AC/DC 48V AC/DC 12V DC 24V AC/DC	TH40561-**J TH40562-**J TH40564-**J TH40566-**J TH40568-**J	
FLASHER (OFF Time 1st)	240V AC/DC 120V AC/DC 48V AC/DC 12V DC 24V AC/DC	TH40861-**J TH40862-**J TH40864-**J TH40866-**J TH40868-**J	<p>DIAGRAM 381</p>
FLASHER (ON Time 1st)	240V AC/DC 120V AC/DC 48V AC/DC 12V DC 24V AC/DC	TH40961-**J TH40962-**J TH40964-**J TH40966-**J TH40968-**J	
REPEAT CYCLE * (OFF Time 1st)	240V AC/DC 120V AC/DC 48V AC/DC 12V DC 24V AC/DC	TH43161-**J TH43162-**J TH43164-**J TH43166-**J TH43168-**J	<p>DIAGRAM 381</p>
REPEAT CYCLE * (ON Time 1st)	240V AC/DC 120V AC/DC 48V AC/DC 12V DC 24V AC/DC	TH45161-**J TH45162-**J TH45164-**J TH45166-**J TH45168-**J	
DELAYED * INTERVAL	240V AC/DC 120V AC/DC 48V AC/DC 12V DC 24V AC/DC	TH46161-**J TH46162-**J TH46164-**J TH46166-**J TH46168-**J	

■ See "Definitions of Timing Functions" at back of catalog.

** Complete Product Number using two-digit Code from Time Range Table below.

TIME DELAY OPTIONS

● **Onboard Adjustable Time Delay**

Complete product number by adding two-digit code from table at right. For example, TH40262-30 is an On Delay with a time delay range of 0.1-10 seconds).

* Dual Time functions come with matching time ranges as standard. See www.macromatic.com/onoff for how to order a unit with non-matching combinations.

● **Onboard Fixed Time Delay**

Replace two-digit code with suffix "F" followed by delay [0.1 ... 100] followed by (S) seconds, (M) minutes or (H) hours. For example, TH40262-F5S is an On Delay with a time delay fixed at 5 seconds.

● **Remote Adjustable Time Delay (R1 Modification)**

Single Time function models can be built with two terminals for remote adjustable or fixed time delays.

** TIME RANGE TABLE	
Time Delay Range	Code
0.05 - 5 seconds	04
0.1 - 10 seconds	30
0.3 - 30 seconds	07
0.6 - 60 seconds	08
1 - 100 seconds	31
1.2 - 120 seconds	09
1.8 - 180 seconds	10
3 - 300 seconds	12
10 - 1,000 seconds	36
0.1 - 10 minutes	32
0.3 - 30 minutes	15
0.6 - 60 minutes	16
1 - 100 minutes	33
10 - 1,000 minutes	37
0.02 - 2 hours	17
0.1 - 10 hours	34
1 - 100 hours	35



- ◆ Effectively and economically operate heavy loads
- ◆ 30A SPDT relay output contacts can control loads without a separate contactor
- ◆ Cost effective design and compact 2" x 3" enclosure are ideal for volume OEM applications
- ◆ Microprocessor-based for superior accuracy and repeatability
- ◆ Encapsulated for resistance to harsh environments
- ◆ Control voltage connected at relay common makes wiring easier
- ◆ Time delays are set using adjustable on-board potentiometers, remote potentiometers, or they can be factory fixed.
- ◆ Time ranges from 0.05 seconds to 100 hours.



Better. By Design.

800.238.7474

WWW.MACROMATIC.COM
SALES@MACROMATIC.COM

TIME DELAY RELAYS | ENCAPSULATED - TH4 SERIES

ON DELAY, WATCHDOG, SINGLE SHOT, OFF DELAY, SINGLE SHOT FALLING EDGE, ON/OFF DELAY, AND DELAYED INTERVAL

RELAY OUTPUT | TH4 SERIES | HIGH AMP

DUAL PIN TRIGGER AND ISOLATED RELAY COMMON



- ◆ Effectively and economically operate heavy loads
- ◆ 30A SPDT relay output contacts can control loads without a separate contactor
- ◆ Cost effective design and compact 2" x 3" enclosure are ideal for volume OEM applications
- ◆ Microprocessor-based for superior accuracy and repeatability
- ◆ Encapsulated for resistance to harsh environments
- ◆ Isolated control switch and isolated relay common
- ◆ Time delays are set using adjustable on-board potentiometers, remote potentiometers, or they can be factory fixed.
- ◆ Time ranges from 0.05 seconds to 100 hours.



Better. By Design.

800.238.7474

WWW.MACROMATIC.COM

SALES@MACROMATIC.COM

FUNCTION ■	CONTROL VOLTAGE	CATALOG NUMBER **	WIRING
ON DELAY (Switch Trigger)	240V AC/DC 120V AC/DC 48V AC/DC 12V DC 24V AC/DC	TH41261-** TH41262-** TH41264-** TH41266-** TH41268-**	<p>DIAGRAM 376</p> <p>Remote Adjustable Time Delay (R1 Modification)</p> <p>DIAGRAM 382</p>
WATCHDOG (Switch Trigger)	240V AC/DC 120V AC/DC 48V AC/DC 12V DC 24V AC/DC	TH41361-** TH41362-** TH41364-** TH41366-** TH41368-**	
SINGLE SHOT (Switch Trigger)	240V AC/DC 120V AC/DC 48V AC/DC 12V DC 24V AC/DC	TH41561-** TH41562-** TH41564-** TH41566-** TH41568-**	
OFF DELAY (Switch Trigger)	240V AC/DC 120V AC/DC 48V AC/DC 12V DC 24V AC/DC	TH41661-** TH41662-** TH41664-** TH41666-** TH41668-**	
SINGLE SHOT FALLING EDGE (Switch Trigger)	240V AC/DC 120V AC/DC 48V AC/DC 12V DC 24V AC/DC	TH42261-** TH42262-** TH42264-** TH42266-** TH42268-**	
ON DELAY/ OFF DELAY (Switch Trigger) *	240V AC/DC 120V AC/DC 48V AC/DC 12V DC 24V AC/DC	TH44161-** TH44162-** TH44164-** TH44166-** TH44168-**	
DELAYED INTERVAL (Switch Trigger) *	240V AC/DC 120V AC/DC 48V AC/DC 12V DC 24V AC/DC	TH46561-** TH46562-** TH46564-** TH46566-** TH46568-**	

■ See "Definitions of Timing Functions" at back of catalog.

** Complete Product Number using two-digit Code from Time Range Table below.

TIME DELAY OPTIONS

● Onboard Adjustable Time Delay

Complete product number by adding two-digit code from table at right. For example, TH40262-30 is an On Delay with a time delay range of 0.1-10 seconds).

* Dual Time functions come with matching time ranges as standard. See www.macromatic.com/onoff for how to order a unit with non-matching combinations.

● Onboard Fixed Time Delay

Replace two-digit code with suffix "F" followed by delay [0.1 ... 100] followed by (S) seconds, (M) minutes or (H) hours. For example, TH40262-F5S is an On Delay with a time delay fixed at 5 seconds.

● Remote Adjustable Time Delay (R1 Modification)

Single Time function models can be built with two terminals for remote adjustable or fixed time delays.

** TIME RANGE TABLE

Time Delay Range	Code
0.05 - 5 seconds	04
0.1 - 10 seconds	30
0.3 - 30 seconds	07
0.6 - 60 seconds	08
1 - 100 seconds	31
1.2 - 120 seconds	09
1.8 - 180 seconds	10
3 - 300 seconds	12
10 - 1,000 seconds	36
0.1 - 10 minutes	32
0.3 - 30 minutes	15
0.6 - 60 minutes	16
1 - 100 minutes	33
10 - 1,000 minutes	37
0.02 - 2 hours	17
0.1 - 10 hours	34
1 - 100 hours	35

ON DELAY, WATCHDOG, SINGLE SHOT, OFF DELAY, SINGLE SHOT FALLING EDGE, ON/OFF DELAY, AND DELAYED INTERVAL

RELAY OUTPUT | TH4 SERIES | HIGH AMP

DUAL PIN TRIGGER & VOLTAGE CONNECTED AT RELAY COMMON

FUNCTION ■	CONTROL VOLTAGE	CATALOG NUMBER **	WIRING
ON DELAY (Switch Trigger)	240V AC/DC 120V AC/DC 48V AC/DC 12V DC 24V AC/DC	TH41261-**-J TH41262-**-J TH41264-**-J TH41266-**-J TH41268-**-J	<p>DIAGRAM 378</p> <p>Adjustable Remote Time Delay (R1 Modification)</p> <p>DIAGRAM 384</p>
WATCHDOG (Switch Trigger)	240V AC/DC 120V AC/DC 48V AC/DC 12V DC 24V AC/DC	TH41361-**-J TH41362-**-J TH41364-**-J TH41366-**-J TH41368-**-J	
SINGLE SHOT (Switch Trigger)	240V AC/DC 120V AC/DC 48V AC/DC 12V DC 24V AC/DC	TH41561-**-J TH41562-**-J TH41564-**-J TH41566-**-J TH41568-**-J	
OFF DELAY (Switch Trigger)	240V AC/DC 120V AC/DC 48V AC/DC 12V DC 24V AC/DC	TH41661-**-J TH41662-**-J TH41664-**-J TH41666-**-J TH41668-**-J	
SINGLE SHOT FALLING EDGE (Switch Trigger)	240V AC/DC 120V AC/DC 48V AC/DC 12V DC 24V AC/DC	TH42261-**-J TH42262-**-J TH42264-**-J TH42266-**-J TH42268-**-J	
ON DELAY*/OFF DELAY* (Switch Trigger) *	240V AC/DC 120V AC/DC 48V AC/DC 12V DC 24V AC/DC	TH44161-**-J TH44162-**-J TH44164-**-J TH44166-**-J TH44168-**-J	
DELAYED INTERVAL (Switch Trigger) *	240V AC/DC 120V AC/DC 48V AC/DC 12V DC 24V AC/DC	TH46561-**-J TH46562-**-J TH46564-**-J TH46566-**-J TH46568-**-J	

■ See "Definitions of Timing Functions" at back of catalog.

** Complete Product Number using two-digit Code from Time Range Table below.

TIME DELAY OPTIONS

● Onboard Adjustable Time Delay

Complete product number by adding two-digit code from table at right. For example, TH40262-30 is an On Delay with a time delay range of 0.1-10 seconds).

* Dual Time functions come with matching time ranges as standard. See www.macromatic.com/onoff for how to order a unit with non-matching combinations.

● Onboard Fixed Time Delay

Replace two-digit code with suffix "F" followed by delay [0.1 ... 100] followed by (S) seconds, (M) minutes or (H) hours. For example, TH40262-F5S is an On Delay with a time delay fixed at 5 seconds.

● Remote Adjustable Time Delay (R1 Modification)

Single Time function models can be built with two terminals for remote adjustable or fixed time delays.

** TIME RANGE TABLE	
Time Delay Range	Code
0.05 - 5 seconds	04
0.1 - 10 seconds	30
0.3 - 30 seconds	07
0.6 - 60 seconds	08
1 - 100 seconds	31
1.2 - 120 seconds	09
1.8 - 180 seconds	10
3 - 300 seconds	12
10 - 1,000 seconds	36
0.1 - 10 minutes	32
0.3 - 30 minutes	15
0.6 - 60 minutes	16
1 - 100 minutes	33
10 - 1,000 minutes	37
0.02 - 2 hours	17
0.1 - 10 hours	34
1 - 100 hours	35



- ◆ Effectively and economically operate heavy loads
- ◆ 30A SPDT relay output contacts can control loads without a separate contactor
- ◆ Cost effective design and compact 2" x 3" enclosure are ideal for volume OEM applications
- ◆ Microprocessor-based for superior accuracy and repeatability
- ◆ Encapsulated for resistance to harsh environments
- ◆ Isolated control switch and isolated relay common
- ◆ Time delays are set using adjustable on-board potentiometers, remote potentiometers, or they can be factory fixed.
- ◆ Time ranges from 0.05 seconds to 100 hours.



Better. By Design.

800.238.7474

WWW.MACROMATIC.COM
SALES@MACROMATIC.COM

TIME DELAY RELAYS | ENCAPSULATED - TH4 SERIES

ON DELAY, WATCHDOG, SINGLE SHOT, OFF DELAY, SINGLE SHOT FALLING EDGE, ON/OFF DELAY, AND DELAYED INTERVAL

RELAY OUTPUT | TH4 SERIES | HIGH AMP

TIME DELAY RELAYS | ENCAPSULATED - TH4 SERIES



- ◆ Effectively and economically operate heavy loads
- ◆ 30A SPDT relay output contacts can control loads without a separate contactor
- ◆ Cost effective design and compact 2" x 3" enclosure are ideal for volume OEM applications
- ◆ Microprocessor-based for superior accuracy and repeatability
- ◆ Encapsulated for resistance to harsh environments
- ◆ Single pin trigger, pin 6
- ◆ Time delays are set using adjustable on-board potentiometers, remote potentiometers, or they can be factory fixed.
- ◆ Time ranges from 0.05 seconds to 100 hours.



Better. By Design.

800.238.7474

WWW.MACROMATIC.COM

SALES@MACROMATIC.COM

SINGLE PIN TRIGGER & ISOLATED RELAY COMMON

FUNCTION ■	CONTROL VOLTAGE	CATALOG NUMBER **	WIRING
ON DELAY (Switch Trigger)	240V AC/DC	TH41261-***T	<p>DIAGRAM 377</p> <p>Remote Adjustable Time Delay (R1 Modification)</p> <p>DIAGRAM 383</p>
	120V AC/DC	TH41262-***T	
	48V AC/DC	TH41264-***T	
	12V DC	TH41266-***T	
	24V AC/DC	TH41268-***T	
WATCHDOG (Switch Trigger)	240V AC/DC	TH41361-***T	
	120V AC/DC	TH41362-***T	
	48V AC/DC	TH41364-***T	
	12V DC	TH41366-***T	
	24V AC/DC	TH41368-***T	
SINGLE SHOT (Switch Trigger)	240V AC/DC	TH41561-***T	
	120V AC/DC	TH41562-***T	
	48V AC/DC	TH41564-***T	
	12V DC	TH41566-***T	
	24V AC/DC	TH41568-***T	
OFF DELAY (Switch Trigger)	240V AC/DC	TH41661-***T	
	120V AC/DC	TH41662-***T	
	48V AC/DC	TH41664-***T	
	12V DC	TH41666-***T	
	24V AC/DC	TH41668-***T	
SINGLE SHOT FALLING EDGE (Switch Trigger)	240V AC/DC	TH42261-***T	
	120V AC/DC	TH42262-***T	
	48V AC/DC	TH42264-***T	
	12V DC	TH42266-***T	
	24V AC/DC	TH42268-***T	
ON DELAY/* OFF DELAY (Switch Trigger) *	240V AC/DC	TH44161-***T	
	120V AC/DC	TH44162-***T	
	48V AC/DC	TH44164-***T	
	12V DC	TH44166-***T	
	24V AC/DC	TH44168-***T	
DELAYED INTERVAL (Switch Trigger) *	240V AC/DC	TH46561-***T	
	120V AC/DC	TH46562-***T	
	48V AC/DC	TH46564-***T	
	12V DC	TH46566-***T	
	24V AC/DC	TH46568-***T	

■ See "Definitions of Timing Functions" at back of catalog.

** Complete Product Number using two-digit Code from Time Range Table below.

TIME DELAY OPTIONS

● Onboard Adjustable Time Delay

Complete product number by adding two-digit code from table at right. For example, TH40262-30 is an On Delay with a time delay range of 0.1-10 seconds).

* Dual Time functions come with matching time ranges as standard. See www.macromatic.com/onoff for how to order a unit with non-matching combinations.

● Onboard Fixed Time Delay

Replace two-digit code with suffix "F" followed by delay [0.1 ... 100] followed by (S) seconds, (M) minutes or (H) hours. For example, TH40262-F5S is an On Delay with a time delay fixed at 5 seconds.

● Remote Adjustable Time Delay (R1 Modification)

Single Time function models can be built with two terminals for remote adjustable or fixed time delays.

** TIME RANGE TABLE

Time Delay Range	Code
0.05 - 5 seconds	04
0.1 - 10 seconds	30
0.3 - 30 seconds	07
0.6 - 60 seconds	08
1 - 100 seconds	31
1.2 - 120 seconds	09
1.8 - 180 seconds	10
3 - 300 seconds	12
10 - 1,000 seconds	36
0.1 - 10 minutes	32
0.3 - 30 minutes	15
0.6 - 60 minutes	16
1 - 100 minutes	33
10 - 1,000 minutes	37
0.02 - 2 hours	17
0.1 - 10 hours	34
1 - 100 hours	35

ON DELAY, WATCHDOG, SINGLE SHOT, OFF DELAY, SINGLE SHOT FALLING EDGE, ON/OFF DELAY, AND DELAYED INTERVAL

RELAY OUTPUT | TH4 SERIES | HIGH AMP

SINGLE PIN TRIGGER & VOLTAGE CONNECTED AT RELAY COMMON

FUNCTION ■	INPUT CATALOG VOLTAGE	NUMBER **	WIRING
ON DELAY (Switch Trigger)	240V AC/DC 120V AC/DC 48V AC/DC 12V DC 24V AC/DC	TH41261-**-JT TH41262-**-JT TH41264-**-JT TH41266-**-JT TH41268-**-JT	
WATCHDOG (Switch Trigger)	240V AC/DC 120V AC/DC 48V AC/DC 12V DC 24V AC/DC	TH41361-**-JT TH41362-**-JT TH41364-**-JT TH41366-**-JT TH41368-**-JT	
SINGLE SHOT (Switch Trigger)	240V AC/DC 120V AC/DC 48V AC/DC 12V DC 24V AC/DC	TH41561-**-JT TH41562-**-JT TH41564-**-JT TH41566-**-JT TH41568-**-JT	
OFF DELAY (Switch Trigger)	240V AC/DC 120V AC/DC 48V AC/DC 12V DC 24V AC/DC	TH41661-**-JT TH41662-**-JT TH41664-**-JT TH41666-**-JT TH41668-**-JT	
SINGLE SHOT FALLING EDGE ww(Switch Trigger)	240V AC/DC 120V AC/DC 48V AC/DC 12V DC 24V AC/DC	TH42261-**-JT TH42262-**-JT TH42264-**-JT TH42266-**-JT TH42268-**-JT	
ON DELAY* OFF DELAY (Switch Trigger) *	240V AC/DC 120V AC/DC 48V AC/DC 12V DC 24V AC/DC	TH44161-**-JT TH44162-**-JT TH44164-**-JT TH44166-**-JT TH44168-**-JT	
DELAYED INTERVAL (Switch Trigger) *	240V AC/DC 120V AC/DC 48V AC/DC 12V DC 24V AC/DC	TH46561-**-JT TH46562-**-JT TH46564-**-JT TH46566-**-JT TH46568-**-JT	

DIAGRAM 379

Remote Adjustable Time Delay (R1 Modification)

DIAGRAM 385



- ◆ Effectively and economically operate heavy loads
- ◆ 30A SPDT relay output contacts can control loads without a separate contactor
- ◆ Cost effective design and compact 2" x 3" enclosure are ideal for volume OEM applications
- ◆ Microprocessor-based for superior accuracy and repeatability
- ◆ Encapsulated for resistance to harsh environments
- ◆ Single pin trigger, pin 6, and control voltage connected at relay common
- ◆ Time delays are set using adjustable on-board potentiometers, remote potentiometers, or they can be factory fixed.
- ◆ Time ranges from 0.05 seconds to 100 hours.



■ See "Definitions of Timing Functions" at back of catalog.

** Complete Product Number using two-digit Code from Time Range Table below.

TIME DELAY OPTIONS

● Onboard Adjustable Time Delay

Complete product number by adding two-digit code from table at right. For example, TH40262-30 is an On Delay with a time delay range of 0.1-10 seconds).

* Dual Time functions come with matching time ranges as standard. See www.macromatic.com/onoff for how to order a unit with non-matching combinations.

● Onboard Fixed Time Delay

Replace two-digit code with suffix "F" followed by delay [0.1 ... 100] followed by (S) seconds, (M) minutes or (H) hours. For example, TH40262-F5S is an On Delay with a time delay fixed at 5 seconds.

● Remote Adjustable Time Delay (R1 Modification)

Single Time function models can be built with two terminals for remote adjustable or fixed time delays.

** TIME RANGE TABLE	
Time Delay Range	Code
0.05 - 5 seconds	04
0.1 - 10 seconds	30
0.3 - 30 seconds	07
0.6 - 60 seconds	08
1 - 100 seconds	31
1.2 - 120 seconds	09
1.8 - 180 seconds	10
3 - 300 seconds	12
10 - 1,000 seconds	36
0.1 - 10 minutes	32
0.3 - 30 minutes	15
0.6 - 60 minutes	16
1 - 100 minutes	33
10 - 1,000 minutes	37
0.02 - 2 hours	17
0.1 - 10 hours	34
1 - 100 hours	35



Better. By Design.

800.238.7474

WWW.MACROMATIC.COM
SALES@MACROMATIC.COM

TIME DELAY RELAYS | ENCAPSULATED - TH4 SERIES

TH4 SERIES

RELAY OUTPUT | HIGH AMP

APPLICATION DATA

Voltage Tolerance:

AC Operation: +10/-15% of nominal at 50/60 Hz
 DC Operation: +10/-15% of nominal

Load (Burden): Maximum of 3 VA for all voltages

Setting Accuracy:

Maximum Setting (Adjustable): +5%, -0%
 Minimum Setting (Adjustable): +0%, -50%
 Fixed Time Delay: ±2% or 50ms, whichever is greater

Repeat Accuracy:

Constant voltage and temperature: ±0.1% or ± 0.04 seconds, whichever is greater
 Changing voltage and temperature within limits: ±5% or ± 0.1 seconds, whichever is greater

Reset Time:

Triggered with Input Voltage: 100ms
 Triggered with Control Switch: 40ms

Start-up Time:

Time from when power is applied until unit is timing:
 0.05 seconds

Maintain Function Time:

Time unit continues to operate after power is removed:
 0.01 Seconds. Interruptions longer than this time may reset the timing cycle.

Units Triggered by a Control Switch:

Minimum required trigger switch closure time is 50ms.

Temperature:

Operating: -28° to 65° C (-18° to 149° F)
 Storage: -40° to 85° C (-40° to 185° F)

Output Contact Ratings:

Ratings	SPDT (NO Contact)	SPDT (NC Contact)
AC 240VAC G.P.	30A	15A
DC 28VDC RES.	20A	10A
Motor Load 115/120/125	1 HP	1/4 HP
Motor Load 230/240/250	2 HP	1/2 HP

Life:

Mechanical: 10,000,000 operations; Full Load: 100,000 operations

Compatibility:

Using a solid state switch to initiate the time sequence is acceptable. See www.macromatic.com/leakage or contact Macromatic for information regarding leakage current limits and other solid state design considerations.

Mounting:

Surface with one #8 or #10 screw;
 Recommended maximum tightening torque: 15 in-lb.

Termination: 0.25" male quick-connect terminals

Approvals:



DIMENSIONS

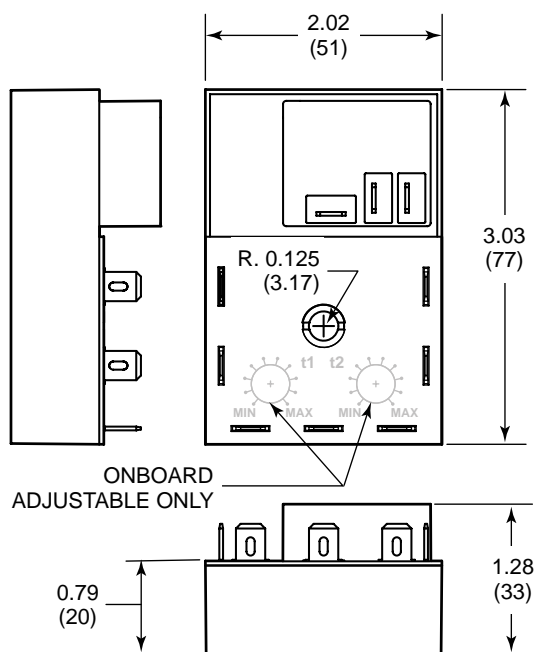

All Dimensions in Inches (Millimeters)

REMOTE TIME DELAY

TH4 Series relays with Single Time Functions can be built with terminals for remote adjustable or remote time delays. To order a product with a remote time delay, complete the Product Number by adding the two-digit Time Range code from the table on the appropriate product selection page, followed by the Remote Potentiometer modification suffix "R1" (i.e., TH40262-30R1).

Adjustable Time Delay

A 100K Ohm Remote Potentiometer is required to obtain the maximum time delay for all standard ranges. To use other values of remote potentiometers, contact Macromatic sales.

Fixed Remote Delay

A fixed time delay can be set by connecting a resistor across the two remote potentiometer terminals. To determine the resistor value required, use the following equation:

$$R = \frac{T}{T_{max}} \times 100,000$$

R = Resistance value required to obtain T
 T = Desired time delay
 T_{max} = Maximum time delay of range

Example: Using time range 0.1-10 seconds, the resistor value required for a fixed time delay of 5 seconds is:

$$R = \frac{5}{10} \times 100,000 = 50,000 \text{ ohms (50K ohms)}$$

ON DELAY, INTERVAL, FLASHER, CYCLE & DELAYED INTERVAL

RELAY OUTPUT | THR-1 SERIES

Isolated Relay Common

FUNCTION ■	INPUT VOLTAGE	CATALOG NUMBER **	WIRING
ON DELAY A	120V AC/DC 12V DC 24V AC/DC 240V AC	THR-10262-** THR-10266-** THR-10268-** THR-10261-**	<p>Onboard Adjustable or Fixed Time Delay</p> <p>DIAGRAM 300</p> <p>Remote Time Delay</p> <p>DIAGRAM 302</p>
INTERVAL ON B	120V AC/DC 12V DC 24V AC/DC 240V AC	THR-10562-** THR-10566-** THR-10568-** THR-10561-**	
FLASHER (OFF Time 1st) E	120V AC/DC 12V DC 24V AC/DC 240V AC	THR-10862-** THR-10866-** THR-10868-** THR-10861-**	
FLASHER (ON Time 1st) F	120V AC/DC 12V DC 24V AC/DC 240V AC	THR-10962-** THR-10966-** THR-10968-** THR-10961-**	
REPEAT CYCLE * (OFF Time 1st) L	120V AC/DC 12V DC 24V AC/DC 240V AC	THR-13162-** THR-13166-** THR-13168-** THR-13161-**	
REPEAT CYCLE * (ON Time 1st) M	120V AC/DC 12V DC 24V AC/DC 240V AC	THR-15162-** THR-15166-** THR-15168-** THR-15161-**	
DELAYED INTERVAL * N	120V AC/DC 12V DC 24V AC/DC 240V AC	THR-16162-** THR-16166-** THR-16168-** THR-16161-**	



- ◆ Cost effective design & compact 2" x 2" enclosure are ideal for volume OEM applications
- ◆ Microprocessor-based design for greater performance & maximum flexibility
- ◆ Encapsulated for protection against harsh environments
- ◆ 10A SPDT relay output contacts can handle most pilot duty & fractional HP loads
- ◆ Onboard & remote adjustable or fixed time delays from 0.05 seconds to 100 hours



■ See "Definitions of Timing Functions".

* ON & OFF Time Ranges for these functions are the same. See www.macromatic.com/onoff for information on how to order a unit with different ON & OFF time ranges.

** Complete Product Number using two-digit Code from Table below.

TIME DELAYS

THR-1 Series Products have three time delay options:

- **Onboard Adjustable Time Delay**--complete Product Number by adding two-digit Code from Table at right, i.e., THR-10262-30 is an On Delay with a time delay range of 0.1-10 seconds. * See www.macromatic.com/onoff for information on how to order these functions with different ON & OFF time ranges.
- **Onboard Fixed Time Delay**--replace two-digit Code with suffix "F" followed by delay [0.1 ... 100] followed by (S) seconds, (M) minutes or (H) hours, i.e., THR-10262-F5S is an On Delay with a time delay fixed at 5 seconds.
- **Remote Time Delay**--THR-1 Series products can be built with two terminals for remote adjustable or fixed time delays.

** TIMING RANGE TABLE	
Time Delay Range	Code
0.05 - 5 Sec.	04
0.1 - 10 Sec.	30
1 - 100 Sec.	31
10 - 1,000 Sec.	36
0.1 - 10 Min.	32
1 - 100 Min.	33
10 - 1,000 Min.	37
1 - 100 Hr.	35



Better. By Design.

800.238.7474

WWW.MACROMATIC.COM
SALES@MACROMATIC.COM

TIME DELAY RELAYS | ENCAPSULATED

ON DELAY, INTERVAL, FLASHER, CYCLE & DELAYED INTERVAL

RELAY OUTPUT | THR-1 SERIES

Relay Common Internally Connected to Pin 2



- ◆ Cost effective design & compact 2" x 2" enclosure are ideal for volume OEM applications
- ◆ Microprocessor-based design for greater performance & maximum flexibility
- ◆ Encapsulated for protection against harsh environments
- ◆ 10A SPDT relay output contacts can handle most pilot duty & fractional HP loads
- ◆ Relay Common internally connected to Pin 2-makes wiring easier
- ◆ Onboard & remote adjustable or fixed time delays from 0.05 seconds to 100 hours



TIME DELAY RELAYS | ENCAPSULATED

FUNCTION ■	INPUT VOLTAGE	CATALOG NUMBER **	WIRING
ON DELAY A	120V AC/DC 12V DC 24V AC/DC 240V AC	THR-10262-**J THR-10266-**J THR-10268-**J THR-10261-**J	Onboard Adjustable or Fixed Time Delay DIAGRAM 301
INTERVAL ON B	120V AC/DC 12V DC 24V AC/DC 240V AC	THR-10562-**J THR-10566-**J THR-10568-**J THR-10561-**J	
FLASHER (OFF Time 1st) E	120V AC/DC 12V DC 24V AC/DC 240V AC	THR-10862-**J THR-10866-**J THR-10868-**J THR-10861-**J	Remote Time Delay DIAGRAM 303
FLASHER (ON Time 1st) F	120V AC/DC 12V DC 24V AC/DC 240V AC	THR-10962-**J THR-10966-**J THR-10968-**J THR-10961-**J	
REPEAT CYCLE * (OFF Time 1st) L	120V AC/DC 12V DC 24V AC/DC 240V AC	THR-13162-**J THR-13166-**J THR-13168-**J THR-13161-**J	
REPEAT CYCLE * (ON Time 1st) M	120V AC/DC 12V DC 24V AC/DC 240V AC	THR-15162-**J THR-15166-**J THR-15168-**J THR-15161-**J	
DELAYED INTERVAL * N	120V AC/DC 12V DC 24V AC/DC 240V AC	THR-16162-**J THR-16166-**J THR-16168-**J THR-16161-**J	

■ See "Definitions of Timing Functions"

** Complete Product Number using two-digit Code from Timing Range Table below.

TIME DELAYS OPTIONS

- **Onboard Adjustable Time Delay**
Complete product number by adding two-digit code from table at right. For example, THR-10262-30J is an On Delay with a time delay range of 0.1-10 seconds).
* ON and OFF Time Ranges for Dual Time functions are the same. See www.macromatic.com/onoff for ordering a unit with different ON and OFF time ranges.
- **Onboard Fixed Time Delay**
Replace two-digit code with suffix "F" followed by delay [0.1 ... 100] followed by (S) seconds, (M) minutes or (H) hours. For example, THR-10262-F5SJ is an On Delay with a time delay fixed at 5 seconds).
- **Remote Adjustable Time Delay**
THR-1 Series products can be built with two terminals for remote adjustable or fixed time delays.

** TIMING RANGE TABLE	
Time Delay Range	Code
0.05 - 5 seconds	04
0.1 - 10 seconds	30
0.3 - 30 seconds	07
0.6 - 60 seconds	08
1 - 100 seconds	31
1.2 - 120 seconds	09
1.8 - 180 seconds	10
3 - 300 seconds	12
10 - 1,000 seconds	36
0.1 - 10 minutes	32
0.3 - 30 minutes	15
0.6 - 60 minutes	16
1 - 100 minutes	33
10 - 1,000 minutes	37
0.02 - 2 hours	17
0.1 - 10 hours	34
1 - 100 hours	35



Better. By Design.

800.238.7474
WWW.MACROMATIC.COM
SALES@MACROMATIC.COM

OFF DELAY, SINGLE SHOT, WATCHDOG, SINGLE SHOT FALLING EDGE, ON DELAY/OFF DELAY & DELAYED INTERVAL

RELAY OUTPUT | THR-1 SERIES

Isolated Control Switch & Isolated Relay Common

FUNCTION ■	INPUT VOLTAGE	CATALOG NUMBER **	WIRING
OFF DELAY ■ C	120V AC/DC 12V DC 24V AC/DC 240V AC	THR-11662-** THR-11666-** THR-11668-** THR-11661-**	Onboard Adjustable or Fixed Time Delay
SINGLE SHOT ■ D	120V AC/DC 12V DC 24V AC/DC 240V AC	THR-11562-** THR-11566-** THR-11568-** THR-11561-**	
WATCHDOG (Retriggerable Single Shot) ■ J	120V AC/DC 12V DC 24V AC/DC 240V AC	THR-11362-** THR-11366-** THR-11368-** THR-11361-**	
SINGLE SHOT FALLING EDGE (Retriggerable) ■ H	120V AC/DC 12V DC 24V AC/DC 240V AC	THR-12262-** THR-12266-** THR-12268-** THR-12261-**	Remote Time Delay
ON/OFF DELAY * ■ G	120V AC/DC 12V DC 24V AC/DC 240V AC	THR-14162-** THR-14166-** THR-14168-** THR-14161-**	
DELAYED INTERVAL * (Triggered) ■ P	120V AC/DC 12V DC 24V AC/DC 240V AC	THR-16562-** THR-16566-** THR-16568-** THR-16561-**	



- ◆ Cost effective design & compact 2" x 2" enclosure are ideal for volume OEM applications
- ◆ Microprocessor-based design for greater performance & maximum flexibility
- ◆ Encapsulated for protection against harsh environments
- ◆ 10A SPDT relay output contacts can handle most pilot duty & fractional HP loads
- ◆ Onboard & remote adjustable or fixed time delays from 0.05 seconds to 100 hours



- See "Definitions of Timing Functions".
- * ON & OFF Time Ranges for Dual Time functions are the same. See www.macromatic.com/onoff for information on how to order a unit with different ON & OFF time ranges.
- ** Complete Product Number using two-digit Code from Table below.

TIME DELAYS

THR-1 Series Products have three time delay options:

- **Onboard Adjustable Time Delay**--complete Product Number by adding two-digit Code from Table at right, i.e., THR-11662-30 is an Off Delay with a time delay range of 0.1-10 seconds.
* See www.macromatic.com/onoff for information on how to order these functions with different ON & OFF time ranges.
- **Onboard Fixed Time Delay**--replace two-digit Code with suffix "F" followed by delay [0.1 ... 100] followed by (S) seconds, (M) minutes or (H) hours, i.e., THR-11662-F5S is an Off Delay with a time delay fixed at 5 seconds.
- **Remote Adjustable Time Delay**--THR-1 Series products can be built with two terminals for remote adjustable or fixed time delays.

** TIMING RANGE TABLE

Time Delay Range	Code
0.05 - 5 Sec.	04
0.1 - 10 Sec.	30
1 - 100 Sec.	31
10 - 1,000 Sec.	36
0.1 - 10 Min.	32
1 - 100 Min.	33
10 - 1,000 Min.	37
1 - 100 Hr.	35



Better. By Design.

800.238.7474

WWW.MACROMATIC.COM
SALES@MACROMATIC.COM

TIME DELAY RELAYS | ENCAPSULATED

OFF DELAY, SINGLE SHOT, WATCHDOG, SINGLE SHOT FALLING EDGE, ON DELAY/OFF DELAY & DELAYED INTERVAL

RELAY OUTPUT | THR-1 SERIES

Isolated Control Switch & Relay Common Internally Connected to Pin 2



- ◆ Cost effective design & compact 2" x 2" enclosure are ideal for volume OEM applications
- ◆ Microprocessor-based design for greater performance & maximum flexibility
- ◆ Encapsulated for protection against harsh environments
- ◆ 10A SPDT relay output contacts can handle most pilot duty & fractional HP loads
- ◆ Relay Common internally connected to Pin 2-makes wiring easier
- ◆ Onboard & remote adjustable or fixed time delays from 0.05 seconds to 100 hours



Better. By Design.

800.238.7474
WWW.MACROMATIC.COM
SALES@MACROMATIC.COM

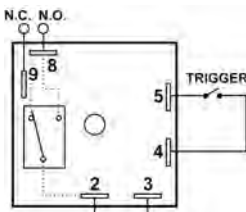
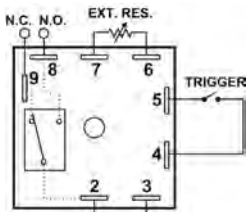
FUNCTION ■	INPUT VOLTAGE	CATALOG NUMBER **	WIRING
OFF DELAY C	120V AC/DC 12V DC 24V AC/DC 240V AC	THR-11662-**J THR-11666-**J THR-11668-**J THR-11661-**J	Onboard Adjustable or Fixed Time Delay 
SINGLE SHOT D	120V AC/DC 12V DC 24V AC/DC 240V AC	THR-11562-**J THR-11566-**J THR-11568-**J THR-11561-**J	Remote Time Delay 
WATCHDOG (Retriggerable Single Shot) J	120V AC/DC 12V DC 24V AC/DC 240V AC	THR-11362-**J THR-11366-**J THR-11368-**J THR-11361-**J	
SINGLE SHOT FALLING EDGE (Retriggerable) H	120V AC/DC 12V DC 24V AC/DC 240V AC	THR-12262-**J THR-12266-**J THR-12268-**J THR-12261-**J	
ON/OFF DELAY * G	120V AC/DC 12V DC 24V AC/DC 240V AC	THR-14162-**J THR-14166-**J THR-14168-**J THR-14161-**J	
DELAYED INTERVAL * P	120V AC/DC 12V DC 24V AC/DC 240V AC	THR-16562-**J THR-16566-**J THR-16568-**J THR-16561-**J	

■ See "Definitions of Timing Functions".

* ON & OFF Time Ranges for these functions are the same. See www.macromatic.com/onoff for information on how to order a unit with different ON & OFF time ranges.

** Complete Product Number using two-digit Code from Table below.

TIME DELAYS

THR-1 Series Products have three time delay options:

- **Onboard Adjustable Time Delay**--complete Product Number by adding two-digit Code from Table at right, i.e., THR-11662-30J is an Off Delay with a time delay range of 0.1-10 seconds.
* See www.macromatic.com/onoff for information on how to order these functions with different ON & OFF time ranges.
- **Onboard Fixed Time Delay**--replace two-digit Code with suffix "F" followed by delay [0.1 ... 100] followed by (S) seconds, (M) minutes or (H) hours, i.e., THR-11662-F5SJ is an Off Delay with a time delay fixed at 5 seconds.
- **Remote Adjustable Time Delay**--THR-1 Series products can be built with two terminals for remote adjustable or fixed time delays.

** TIMING RANGE TABLE

Time Delay Range	Code
0.05 - 5 Sec.	04
0.1 - 10 Sec.	30
1 - 100 Sec.	31
10 - 1,000 Sec.	36
0.1 - 10 Min.	32
1 - 100 Min.	33
10 - 1,000 Min.	37
1 - 100 Hr.	35

OFF DELAY, SINGLE SHOT, WATCHDOG, SINGLE SHOT FALLING EDGE, ON DELAY/OFF DELAY & DELAYED INTERVAL

RELAY OUTPUT | THR-1 SERIES

Control Switch Common to Pin 2 & Isolated Relay Common

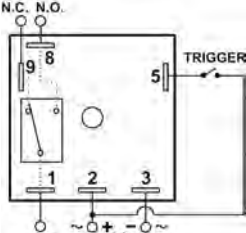
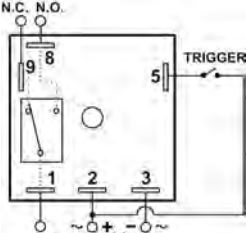
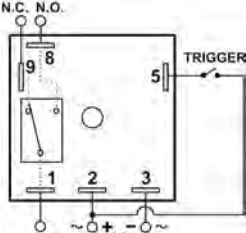
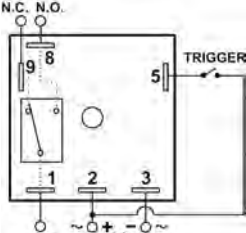
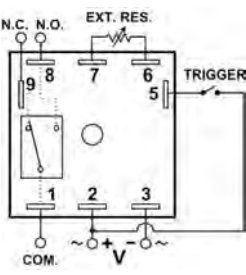
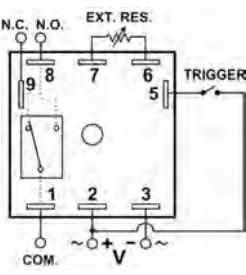
FUNCTION ■	INPUT VOLTAGE	CATALOG NUMBER **	WIRING
OFF DELAY C	120V AC/DC 12V DC 24V AC/DC 240V AC	THR-11662-**T THR-11666-**T THR-11668-**T THR-11661-**T	Onboard Adjustable or Fixed Time Delay 
SINGLE SHOT D	120V AC/DC 12V DC 24V AC/DC 240V AC	THR-11562-**T THR-11566-**T THR-11568-**T THR-11561-**T	
WATCHDOG (Retriggerable Single Shot) J	120V AC/DC 12V DC 24V AC/DC 240V AC	THR-11362-**T THR-11366-**T THR-11368-**T THR-11361-**T	
SINGLE SHOT FALLING EDGE (Retriggerable) H	120V AC/DC 12V DC 24V AC/DC 240V AC	THR-12262-**T THR-12266-**T THR-12268-**T THR-12261-**T	
ON/OFF DELAY * G	120V AC/DC 12V DC 24V AC/DC 240V AC	THR-14162-**T THR-14166-**T THR-14168-**T THR-14161-**T	
DELAYED INTERVAL * (Triggered) P	120V AC/DC 12V DC 24V AC/DC 240V AC	THR-16562-**T THR-16566-**T THR-16568-**T THR-16561-**T	



- ◆ Cost effective design & compact 2" x 2" enclosure are ideal for volume OEM applications
- ◆ Microprocessor-based design for greater performance & maximum flexibility
- ◆ Encapsulated for protection against harsh environments
- ◆ 10A SPDT relay output contacts can handle most pilot duty & fractional HP loads
- ◆ Onboard & remote adjustable or fixed time delays from 0.05 seconds to 100 hours



■ See "Definitions of Timing Functions".
 * ON & OFF Time Ranges for these functions are the same. See www.macromatic.com/onoff for information on how to order a unit with different ON & OFF time ranges.
 ** Complete Product Number using two-digit Code from Table below.

TIME DELAYS

THR-1 Series Products have three time delay options:

- **Onboard Adjustable Time Delay**--complete Product Number by adding two-digit Code from Table at right, i.e., THR-11662-30T is an Off Delay with a time delay range of 0.1-10 seconds. * See www.macromatic.com/onoff for information on how to order these functions with different ON & OFF time ranges.
- **Onboard Fixed Time Delay**--replace two-digit Code with suffix "F" followed by delay [0.1 ... 100] followed by (S) seconds, (M) minutes or (H) hours, i.e., THR-11662-F5ST is an Off Delay with a time delay fixed at 5 seconds.
- **Remote Adjustable Time Delay**--THR-1 Series products can be built with two terminals for remote adjustable or fixed time delays.

** TIMING RANGE TABLE

Time Delay Range	Code
0.05 - 5 Sec.	04
0.1 - 10 Sec.	30
1 - 100 Sec.	31
10 - 1,000 Sec.	36
0.1 - 10 Min.	32
1 - 100 Min.	33
10 - 1,000 Min.	37
1 - 100 Hr.	35



Better. By Design.

800.238.7474

WWW.MACROMATIC.COM
SALES@MACROMATIC.COM

TIME DELAY RELAYS | ENCAPSULATED

OFF DELAY, SINGLE SHOT, WATCHDOG, SINGLE SHOT FALLING EDGE, ON DELAY/OFF DELAY & DELAYED INTERVAL

RELAY OUTPUT | THR-1 SERIES



- ◆ Cost effective design & compact 2" x 2" enclosure are ideal for volume OEM applications
- ◆ Microprocessor-based design for greater performance & maximum flexibility
- ◆ Encapsulated for protection against harsh environments
- ◆ 10A SPDT relay output contacts can handle most pilot duty & fractional HP loads
- ◆ Relay Common internally connected to Pin 2-makes wiring easier
- ◆ Onboard & remote adjustable or fixed time delays from 0.05 seconds to 100 hours



TIME DELAY RELAYS | ENCAPSULATED



Better. By Design.

800.238.7474

WWW.MACROMATIC.COM

SALES@MACROMATIC.COM

Control Switch Common to Pin 2 &
Relay Common Internally Connected to Pin 2

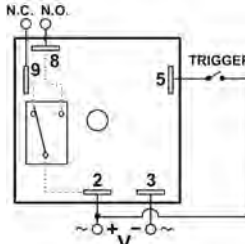
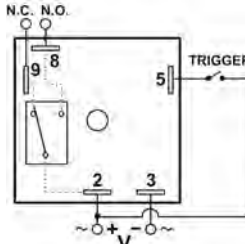
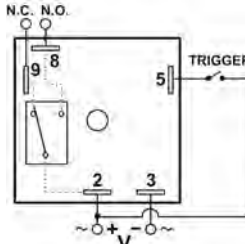
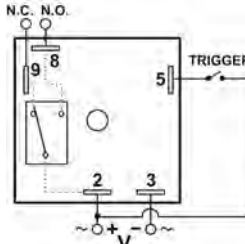
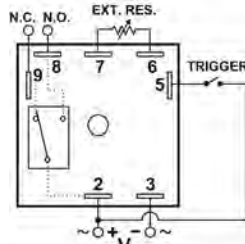
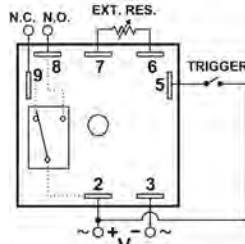
FUNCTION ■	INPUT VOLTAGE	CATALOG NUMBER **	WIRING
OFF DELAY C	120V AC/DC 12V DC 24V AC/DC 240V AC	THR-11662-**JT THR-11666-**JT THR-11668-**JT THR-11661-**JT	Onboard Adjustable or Fixed Time Delay 
SINGLE SHOT D	120V AC/DC 12V DC 24V AC/DC 240V AC	THR-11562-**JT THR-11566-**JT THR-11568-**JT THR-11561-**JT	
WATCHDOG (Retriggerable Single Shot) J	120V AC/DC 12V DC 24V AC/DC 240V AC	THR-11362-**JT THR-11366-**JT THR-11368-**JT THR-11361-**JT	
SINGLE SHOT FALLING EDGE (Retriggerable) H	120V AC/DC 12V DC 24V AC/DC 240V AC	THR-12262-**JT THR-12266-**JT THR-12268-**JT THR-12261-**JT	
ON/OFF DELAY * G	120V AC/DC 12V DC 24V AC/DC 240V AC	THR-14162-**JT THR-14166-**JT THR-14168-**JT THR-14161-**JT	
DELAYED INTERVAL * (Triggered) P	120V AC/DC 12V DC 24V AC/DC 240V AC	THR-16562-**JT THR-16566-**JT THR-16568-**JT THR-16561-**JT	

■ See "Definitions of Timing Functions".

** Complete Product Number using two-digit Code from Time Range Table below.

TIME DELAY OPTIONS

● Onboard Adjustable Time Delay

Complete Product Number by adding two-digit Code from table at right. For example, THR-11662-30JT is an Off Delay with a time delay range of 0.1-10 seconds.

* ON and OFF Time Ranges for Dual Time functions are the same. See www.macromatic.com/onoff for how to order these functions with different ON & OFF time ranges.

● Onboard Fixed Time Delay

Replace two-digit Code with suffix "F" followed by delay [0.1 ... 100] followed by (S) seconds, (M) minutes or (H) hours. For example, THR-11662-F5SJT is an Off Delay with a time delay fixed at 5 seconds.

● Remote Adjustable Time Delay

THR-1 Series products can be built with terminals for remote adjustable or fixed time delays.

** TIMING RANGE TABLE

Time Delay Range	Code
0.05 - 5 Sec.	04
0.1 - 10 Sec.	30
1 - 100 Sec.	31
10 - 1,000 Sec.	36
0.1 - 10 Min.	32
1 - 100 Min.	33
10 - 1,000 Min.	37
1 - 100 Hr.	35

THR-1 SERIES

RELAY OUTPUT

APPLICATION DATA

Voltage Tolerance:

AC Operation: +10/-15% of nominal at 50/60 Hz
 DC Operation: +10/-15% of nominal

Load (Burden): Maximum of 2 VA for all voltages

Setting Accuracy:

Maximum Setting (Adjustable): +5%, -0%
 Minimum Setting (Adjustable): +0%, -50%
 Fixed Time Delay: ±2% or 50ms, whichever is greater

Repeat Accuracy (constant voltage and temperature):

±0.1% or ± 0.04 seconds, whichever is greater

Reset Time:

Triggered with Input Voltage: 100ms
 Triggered with Control Switch: 40ms

Start-up Time (Time from when power is applied until unit is timing): 0.05 Seconds

Maintain Function Time (Time unit continues to operate after power is removed): 0.01 Seconds

Units Triggered by a Control Switch:

Minimum required trigger switch closure time is 50ms.

Temperature:

Operate: -28° to 65°C (-18° to 149°F)
 Storage: -45° to 85°C (-49° to 185°F)

Output Contacts:

10A @ 240VAC / 7A @ 28VDC SPDT, ¼hp @ 120VAC (N.O.)

Life:

Mechanical: 10,000,000 operations
 Full Load: 100,000 operations

Compatibility:

Using a solid state switch to initiate the time sequence is acceptable. See www.macromatic.com/leakage or contact Macromatic for information regarding leakage current limits and other solid state design considerations.

Mounting:

Surface with one #8 or #10 screw and a maximum tightening torque of 15 in-lbs.

Termination:

0.25" male quick-connect terminals

Approvals:



DIMENSIONS

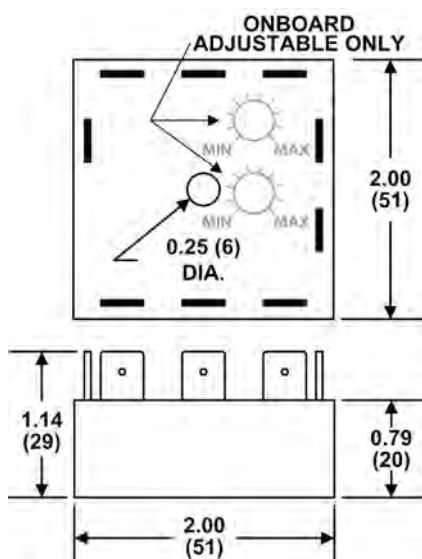

All Dimensions in Inches (Millimeters)

REMOTE TIME DELAY

THR-1 Series relays with Single Time Functions can be built with terminals for remote adjustable or remote time delays. To order a product with a remote time delay, complete the Product Number by adding the two-digit Time Range code from the table on the appropriate product selection page, followed by the Remote Potentiometer modification suffix "R1" (i.e., THR-10262-30R1).

Adjustable Time Delay

A 100K Ohm Remote Potentiometer is required to obtain the maximum time delay for all standard ranges. To use other values of remote potentiometers, contact Macromatic sales.

Fixed Remote Delay

A fixed time delay can be set by connecting a resistor across the two remote potentiometer terminals. To determine the resistor value required, use the following equation:

$$R = \frac{T}{T_{\max}} \times 100,000$$

R = Resistance value required to obtain T
 T = Desired time delay
 T_{\max} = Maximum time delay of range

Example: Using time range 0.1-10 seconds, what resistor value is required for a fixed time delay of 5 seconds:

$$R = \frac{5}{10} \times 100,000 = 50,000 \text{ ohms (50K ohms)}$$

PROGRAMMABLE MULTI-FUNCTION | MULTI-TIME RANGE | MULTI-VOLTAGE RELAY OUTPUT | THR-3 SERIES



- ◆ Three Catalog Numbers Offer All These Features:
 - ▶ Multi-Function: 4 common time delay functions in each one
 - ▶ Universal Voltage: 24-240VAC & 12-125VDC
 - ▶ Time Ranges: 0.1 Sec to 100 Minutes (1,000 Minutes on Dual Time product)
 - ▶ Onboard & remote adjust of time delay (remote adjust not offered on THR-3856U)
 - ▶ THR-3856U allows different ON & OFF times
- ◆ Cost effective design & compact 2" x 2" enclosure
- ◆ Encapsulated for protection against harsh environments
- ◆ 10A SPDT relay output contacts can handle most pilot duty & fractional HP loads



Better. By Design.

800.238.7474
WWW.MACROMATIC.COM
SALES@MACROMATIC.COM

The THR-3 Series products are designed to replace thousands of products from Macromatic and many other manufacturers with just three Catalog Numbers. Each comes with four functions and four timing ranges covering 0.1 second to 100 minutes (1,000 minutes on THR-3856U dual time unit). On the same unit, choose between onboard adjustable, onboard fixed and remote adjustable time delay setting (remote time delay not available on THR-3856U). All set up is done with DIP switches for ease of use. A universal input voltage of 24-240V AC and 12-125V DC adds to the ultimate flexibility of these products. All products are encapsulated for protection against harsh elements. A 10A SPDT relay output rating can handle most pilot duty and fractional HP loads.

FUNCTIONS (4 in each Product)	INPUT VOLTAGE	CATALOG NUMBER	WIRING
<ul style="list-style-type: none"> ● ON DELAY ● OFF DELAY ● INTERVAL ● SINGLE SHOT 	24-240V AC & 12-125V DC	THR-3816U	<p style="text-align: center;">Diagram 348</p>
<ul style="list-style-type: none"> ● FLASHER OFF ● FLASHER ON ● WATCHDOG ● SINGLE SHOT FALLING EDGE 	24-240V AC & 12-125V DC	THR-3836U	<p style="text-align: center;">Diagram 352</p>
<ul style="list-style-type: none"> ● REPEAT CYCLE OFF ● REPEAT CYCLE ON ● DELAYED INTERVAL ● DELAYED INTERVAL (TRIGGERED) 	24-240V AC & 12-125V DC	THR-3856U *	<p style="text-align: center;">Diagram 352</p>

Some functions require the use of a Trigger to initiate the unit.

See Macromatic Catalog or www.macromatic.com/functions for definitions & explanations of Timing Functions.

* The THR-3856U has independently selectable & adjustable ON & OFF times.

TIME DELAYS

THR-3 Series Products have three time delay options (two for THR-3856U dual-time product):

- **Onboard Adjustable Time Delay**-after selecting the desired time range, use the top-mounted potentiometer provided with the unit to adjust within that range (The THR-3856U has independently selectable & adjustable ON & OFF times).
- **Onboard Fixed Time Delay**-although these units come with an onboard potentiometer, they can be used to replace products with fixed time delays. After selecting the desired time range, set the top-mounted potentiometer at the fixed delay required (epoxy can be applied to prevent further changes if desired).
- **Remote Time Delay (THR-3816U & THR-3836U only)**-after selecting the desired time range & setting up the unit for remote time delay adjustment, connect a remote potentiometer for remote adjustability or a resistor for fixed time delay. Note that these products will only work with 100K, 1M or 2M remote potentiometers or resistors.

PROGRAMMABLE MULTI-FUNCTION | MULTI-TIME RANGE | MULTI-VOLTAGE RELAY OUTPUT | THR-3 SERIES

APPLICATION DATA

Voltage Tolerance:

AC Operation: +10/-15% of nominal at 50/60 Hz

DC Operation: +10/-15% of nominal

Load (Burden): Maximum of 2 VA for all voltages

Setting Accuracy:

Maximum Setting (Adjustable): +5%, -0%

Minimum Setting (Adjustable): +0%, -50%

Repeat Accuracy (constant voltage and temperature):

±0.1% or ± 0.04 seconds, whichever is greater

Reset Time:

Triggered with Input Voltage: 100ms

Triggered with Control Switch: 40ms

Start-up Time (Time from when power is applied until unit is timing):

0.05 Seconds

Maintain Function Time (Time unit continues to operate after power is removed):

0.01 Seconds

Units Triggered by a Control Switch:

Minimum required trigger switch closure time is 50ms.

Temperature: Operating: -28° to 65°C (-18° to 149°F)

Storage: -40° to 85°C (-40° to 185°F)

Output Contacts:

10A @ 240VAC / 7A @ 28VDC SPDT, ¼hp @ 120VAC (N.O.)

Life:

Mechanical: 10,000,000 operations

Full Load: 100,000 operations

Compatibility:

Using a solid state switch to initiate the time sequence is acceptable.

See www.macromatic.com/leakage or contact Macromatic for information regarding leakage current limits and other solid state design considerations.

Mounting:

Surface with one #8 or #10 screw and a maximum tightening torque of 15 in-lbs.

Termination:

0.25" male quick-connect terminals

Approvals:



DIMENSIONS

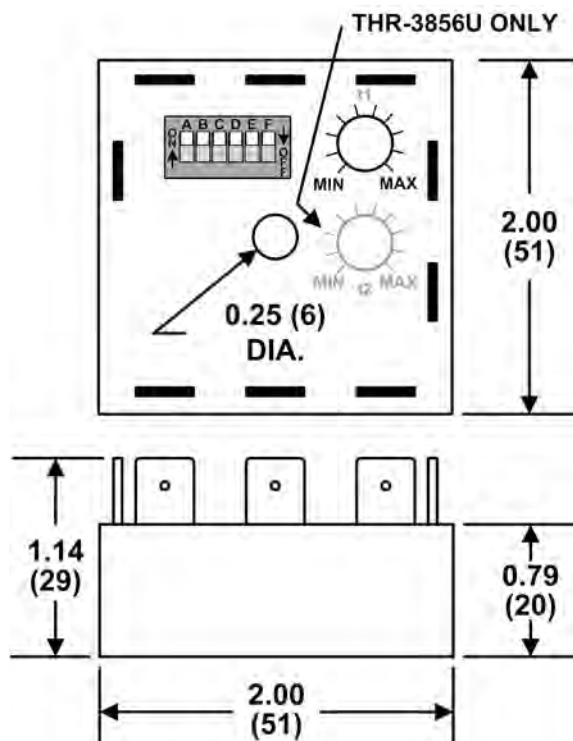

All Dimensions in Inches (Millimeters)

TIME DELAY RELAYS | ENCAPSULATED

ON DELAY, INTERVAL, FLASHER, CYCLE & DELAYED INTERVAL

SOLID STATE OUTPUT | THS-1 SERIES

TIME DELAY RELAYS | ENCAPSULATED



- ◆ Cost effective design & compact 2" x 2" enclosure are ideal for volume OEM applications
- ◆ Microprocessor-based design for greater performance & maximum flexibility
- ◆ Encapsulated for protection against harsh environments
- ◆ Output rated 1A continuous/10A inrush is perfect for high duty cycle/long life applications
- ◆ Onboard & remote adjustable or fixed time delays from 0.01 seconds to 100 hours
- ◆ Built-in load suppression eliminates need for separate protection
- ◆ Pilot duty rating



Better. By Design.

800.238.7474

WWW.MACROMATIC.COM

SALES@MACROMATIC.COM

FUNCTION ■	INPUT VOLTAGE	CATALOG NUMBER **	WIRING ❖
ON DELAY □ A	24-240V AC 12-125V DC	THS-1024A-** THS-1024D-**	Onboard Adjustable or Fixed Time Delay
INTERVAL ON B	24-240V AC 12-125V DC	THS-1054A-** THS-1054D-**	
FLASHER (ON Time 1st) E	24-240V AC 12-125V DC	THS-1094A-** THS-1094D-**	Remote Time Delay
REPEAT CYCLE * (OFF Time 1st) L	24-240V AC 12-125V DC	THS-1314A-** THS-1314D-**	
REPEAT CYCLE * (ON Time 1st) M	24-240V AC 12-125V DC	THS-1514A-** THS-1514D-**	Remote Time Delay
DELAYED INTERVAL * N	24-240V AC 12-125V DC	THS-1614A-** THS-1614D-**	

- See "Definitions of Timing Functions".
- See Inline (Series-Connection) On Delay.
- ❖ Diagrams shown are for products with AC input voltage. For products with DC input voltage, the "+" terminal is 2 & the "-" terminal is 3.
- * ON & OFF Time Ranges for these functions are the same. See www.macromatic.com/onoff for information on how to order a unit with different ON & OFF time ranges.
- ** Complete Product Number using two-digit Code from Table below.

TIME DELAYS

THS-1 Series Products have three time delay options:

- **Onboard Adjustable Time Delay**--complete Product Number by adding two-digit Code from Table at right, i.e., THS-1054A-30 is an Interval On with a time delay range of 0.1-10 seconds. * See www.macromatic.com/onoff for information on how to order these functions with different ON & OFF time ranges.
- **Onboard Fixed Time Delay**--replace two-digit Code with suffix "F" followed by delay [0.1 ... 100] followed by (S) seconds, (M) minutes or (H) hours, i.e., THS-1054A-F5S is an Interval On with a time delay fixed at 5 seconds.
- **Remote Time Delay**--THS-1 Series products can be built with two terminals for remote adjustable or fixed time delays.

** TIMING RANGE TABLE	
Time Delay Range	Code
0.01 - 1 Sec.	02
0.05 - 5 Sec.	04
0.1 - 10 Sec.	30
1 - 100 Sec.	31
10 - 1,000 Sec.	36
0.1 - 10 Min.	32
1 - 100 Min.	33
10 - 1,000 Min.	37
1 - 100 Hr.	35

Build your Time Delay Relays with the [Online Product Builder](#)

OFF DELAY, SINGLE SHOT, WATCHDOG, SINGLE SHOT FALLING EDGE, ON DELAY/OFF DELAY & DELAYED INTERVAL

SOLID STATE OUTPUT | THS-1 SERIES

Isolated Control Switch

FUNCTION ■	INPUT VOLTAGE	CATALOG NUMBER **	WIRING ❖
OFF DELAY C	24-240V AC 12-125V DC	THS-1164A-** THS-1164D-**	<p>DIAGRAM 318</p> <p>DIAGRAM 321</p>
SINGLE SHOT D	24-240V AC 12-125V DC	THS-1154A-** THS-1154D-**	
WATCHDOG (Retriggerable Single Shot) J	24-240V AC 12-125V DC	THS-1134A-** THS-1134D-**	
SINGLE SHOT FALLING EDGE (Retriggerable) H	24-240V AC 12-125V DC	THS-1224A-** THS-1224D-**	
ON/OFF DELAY * G	24-240V AC 12-125V DC	THS-1414A-** THS-1414D-**	
DELAYED INTERVAL * (Retriggerable) P	24-240V AC 12-125V DC	THS-1654A-** THS-1654D-**	



- ◆ Cost effective design & compact 2" x 2" enclosure are ideal for volume OEM applications
- ◆ Microprocessor-based design for greater performance & maximum flexibility
- ◆ Encapsulated for protection against harsh environments
- ◆ Output rated 1A continuous/10A inrush is perfect for high duty cycle/long life applications
- ◆ Onboard & remote adjustable or fixed time delays from 0.01 seconds to 100 hours
- ◆ Built-in load suppression eliminates need for separate protection
- ◆ Pilot duty rating



■ See "Definitions of Timing Functions".

❖ Diagrams shown are for products with AC input voltage. For products with DC input voltage, the "+" terminal is 2 & the "-" terminal is 3.

* ON & OFF Time Ranges for these functions are the same. See www.macromatic.com/onoff for information on how to order a unit with different ON & OFF time ranges.

** Complete Product Number using two-digit Code from Table below.

TIME DELAYS

THS-1 Series Products have three time delay options:

- **Onboard Adjustable Time Delay**--complete Product Number by adding two-digit Code from Table at right, i.e., THS-1164A-30 is an Off Delay with a time delay range of 0.1-10 seconds. * See www.macromatic.com/onoff for information on how to order these functions with different ON & OFF time ranges.
- **Onboard Fixed Time Delay**--replace two-digit Code with suffix "F" followed by delay [0.1 ... 100] followed by (S) seconds, (M) minutes or (H) hours, i.e., THS-1164A-F5S is an Off Delay with a time delay fixed at 5 seconds.
- **Remote Time Delay**--THS-1 Series products can be built with two terminals for remote adjustable or fixed time delays.

** TIMING RANGE TABLE

Time Delay Range	Code
0.01 - 1 Sec.	02
0.05 - 5 Sec.	04
0.1 - 10 Sec.	30
1 - 100 Sec.	31
10 - 1,000 Sec.	36
0.1 - 10 Min.	32
1 - 100 Min.	33
10 - 1,000 Min.	37
1 - 100 Hr.	35



Better. By Design.

800.238.7474

WWW.MACROMATIC.COM

SALES@MACROMATIC.COM

Build your Time Delay Relays with the [Online Product Builder](#)

TIME DELAY RELAYS | ENCAPSULATED

OFF DELAY, SINGLE SHOT, WATCHDOG, SINGLE SHOT FALLING EDGE, ON DELAY/OFF DELAY & DELAYED INTERVAL

SOLID STATE OUTPUT | THS-1 SERIES

Control Switch Common to Pin 2



- ◆ Cost effective design & compact 2" x 2" enclosure are ideal for volume OEM applications
- ◆ Microprocessor-based design for greater performance & maximum flexibility
- ◆ Encapsulated for protection against harsh environments
- ◆ Output rated 1A continuous/10A inrush is perfect for high duty cycle/long life applications
- ◆ Onboard & remote adjustable or fixed time delays from 0.01 seconds to 100 hours
- ◆ Built-in load suppression eliminates need for separate protection
- ◆ Pilot duty rating



Better. By Design.

800.238.7474

WWW.MACROMATIC.COM

SALES@MACROMATIC.COM

FUNCTION ■	INPUT VOLTAGE	CATALOG NUMBER **	WIRING ❖
OFF DELAY C	24-240V AC 12-125V DC	THS-1164A-**T THS-1164D-**T	<p>DIAGRAM 319</p> <p>DIAGRAM 322</p>
SINGLE SHOT D	24-240V AC 12-125V DC	THS-1154A-**T THS-1154D-**T	
WATCHDOG (Retriggerable Single Shot) J	24-240V AC 12-125V DC	THS-1134A-**T THS-1134D-**T	
SINGLE SHOT FALLING EDGE (Retriggerable) H	24-240V AC 12-125V DC	THS-1224A-**T THS-1224D-**T	
ON/OFF DELAY * G	24-240V AC 12-125V DC	THS-1414A-**T THS-1414D-**T	
DELAYED INTERVAL * (Retriggerable) P	24-240V AC 12-125V DC	THS-1654A-**T THS-1654D-**T	

■ See "Definitions of Timing Functions".

❖ Diagrams shown are for products with AC input voltage. For products with DC input voltage, the "+" terminal is 2 & the "-" terminal is 3.

* ON & OFF Time Ranges for these functions are the same. See www.macromatic.com/onoff for information on how to order a unit with different ON & OFF time ranges.

** Complete Product Number using two-digit Code from Table below.

TIME DELAYS

THS-1 Series Products have three time delay options:

- **Onboard Adjustable Time Delay**--complete Product Number by adding two-digit Code from Table at right, i.e., THS-1164A-30T is an Off Delay with a time delay range of 0.1-10 seconds. * See www.macromatic.com/onoff for information on how to order these functions with different ON & OFF time ranges.
- **Onboard Fixed Time Delay**--replace two-digit Code with suffix "F" followed by delay [0.1 ... 100] followed by (S) seconds, (M) minutes or (H) hours, i.e., THS-1164A-F5ST is an Off Delay with a time delay fixed at 5 seconds.
- **Remote Time Delay**--THS-1 Series products can be built with two terminals for remote adjustable or fixed time delays.

** TIMING RANGE TABLE

Time Delay Range	Code
0.01 - 1 Sec.	02
0.05 - 5 Sec.	04
0.1 - 10 Sec.	30
1 - 100 Sec.	31
10 - 1,000 Sec.	36
0.1 - 10 Min.	32
1 - 100 Min.	33
10 - 1,000 Min.	37
1 - 100 Hr.	35

Build your Time Delay Relays with the [Online Product Builder](#)

THS-1 SERIES

SOLID STATE OUTPUT

APPLICATION DATA

Voltage Tolerance:

AC Operation: +10 to -15% of nominal voltage, 50/60 Hz
 DC Operation: +10 to -15% of nominal voltage

Load (Burden): Maximum of 1VA for all voltages

Setting Accuracy:

Maximum Setting (Adjustable): +5%, -0%
 Minimum Setting (Adjustable): +0%, -50%
 Fixed Time Delay: ±2% or 50ms, whichever is greater

Repeat Accuracy (constant voltage and temperature):

±0.1% or ± 0.04 seconds, whichever is greater

Reset Time:

Triggered with Input Voltage: 50ms
 Triggered with Control Switch: 40ms

Start-up Time:

(Time from when power is applied until unit is timing)
 0.05 Seconds

Maintain Function Time:

(Time unit continues to operate after power is removed)
 0.01 Seconds

Units Triggered by a Control Switch:

Minimum required trigger switch closure time is 50ms.

Temperature: Operating: -28° to 65°C (-18° to 149°F)
 Storage: -40° to 85°C (-40° to 185°F)

Output Contacts:

Normally Open Solid State 1A Continuous, 10A Inrush @ 65° C, Pilot Duty

Life:

No predictable failure if used within operating parameters.

Leakage Current (OFF-State): < 5ma @ 240V AC

Minimum Load Current: 20ma

Effective Voltage Drop (ON-State): Maximum 1.6V @ 1A for all voltages

Compatibility:

Using a solid state switch to initiate the time sequence is acceptable. See www.macromatic.com/leakage or contact Macromatic for information regarding leakage current limits and other solid state design considerations.

Mounting:

Surface with one #8 or #10 screw and a maximum tightening torque of 15 in-lbs.

Termination:

0.25" male quick-connect terminals

Approvals:



DIMENSIONS

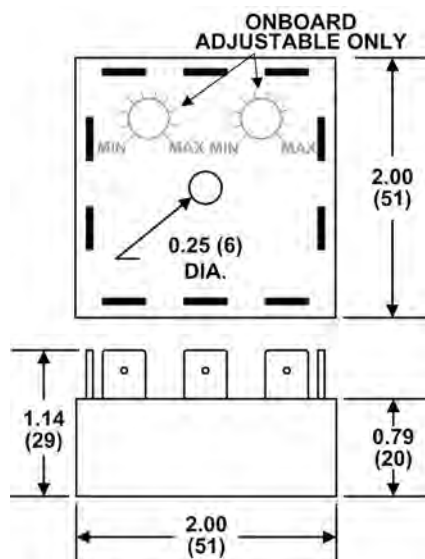

All Dimensions in Inches (Millimeters)

REMOTE TIME DELAY

THS-1 Series products can be built with two terminals for remote adjustable or fixed time delays. To order a product with a remote time delay, complete the Product Number by adding the two-digit Code from the Table shown on the appropriate product selection page followed by the suffix "R1", i.e., THS-10242-30R1.

Adjustable Time Delay

A 100K ohm potentiometer is required to obtain the maximum time delay for all standard ranges. To use other values of remote potentiometers, contact Macromatic.

Fixed Time Delay

A fixed time delay can be set by connecting a resistor across the two terminals. To determine the resistor value required, use the following equation:

$$R = \frac{T}{T_{max}} \times 100,000$$

R = Resistance value required to obtain T
 T = Desired time delay
 T_{max} = Maximum time delay of range

Example: Using time range 0.1-10 seconds, what resistor value is required for a fixed time delay of 5 seconds:

$$R = \frac{5}{10} \times 100,000 = 50,000 \text{ ohms (50K ohms)}$$

ON DELAY | INLINE (SERIES CONNECTION)

SOLID STATE OUTPUT | ANALOG-SET | THL-1 SERIES



- ◆ Universal input voltage: 24-240V AC & 12-48V DC
- ◆ Onboard & remote adjustable or fixed time delays from 0.01 seconds to 100 hours
- ◆ Two-terminal series-connection with the load
- ◆ Cost effective design & compact 2" x 2" enclosure are ideal for volume OEM applications
- ◆ Microprocessor-based design for greater performance & maximum flexibility
- ◆ Encapsulated for protection against harsh environments
- ◆ Output rated 1A continuous/10A inrush pilot duty is perfect for high duty cycle/long life applications



Better. By Design.

800.238.7474

WWW.MACROMATIC.COM

SALES@MACROMATIC.COM

FUNCTION ■	INPUT VOLTAGE	CATALOG NUMBER **	WIRING
ON DELAY A	24-240V AC & 12-48V DC	THL-1024U-**	<p>Onboard Adjustable or Fixed Time Delay</p> <p>DIAGRAM 329</p> <p>Remote Time Delay</p> <p>DIAGRAM 330</p>

■ See "Definitions of Timing Functions".

** Complete Product Number using two-digit Code from Table below.

TIME DELAYS

THL-1 Series Products have three time delay options:

- **Onboard Adjustable Time Delay**--complete Product Number by adding two-digit Code from Table at right, i.e., THL-1024U-30 is an On Delay with a time delay range of 0.1-10 seconds.
- **Onboard Fixed Time Delay**--replace two-digit Code with suffix "F" followed by delay [0.1 ... 100] followed by (S) seconds, (M) minutes or (H) hours, i.e., THL-1024U-F5S is an On Delay with a time delay fixed at 5 seconds.
- **Remote Time Delay**--THL-1 Series products can be built with two terminals for remote adjustable or fixed time delays.

** TIMING RANGE TABLE	
Time Delay Range	Code
0.01 - 1 Sec.	02
0.05 - 5 Sec.	04
0.1 - 10 Sec.	30
1 - 100 Sec.	31
10 - 1,000 Sec.	36
0.1 - 10 Min.	32
1 - 100 Min.	33
10 - 1,000 Min.	37
1 - 100 Hr.	35

Build your Time Delay Relays with the [Online Product Builder](#)

ON DELAY | INLINE (SERIES CONNECTION)

SOLID STATE OUTPUT | ANALOG-SET | THL-1 SERIES

APPLICATION DATA

Voltage Tolerance:

AC Operation: +10 to -15% of nominal voltage, 50/60 Hz
 DC Operation: +10 to -15% of nominal voltage

Load (Burden): Maximum of 1 VA for all voltages

Setting Accuracy:

Maximum Setting (Adjustable): +5%, -0%
 Minimum Setting (Adjustable): +0%, -50%
 Fixed Time Delay: ±2% or 50ms, whichever is greater

Repeat Accuracy (constant voltage and temperature):

±0.1% or ± 0.01 seconds, whichever is greater

Reset Time: 50ms

Start-up Time:

(Time from when power is applied until unit is timing)

0.02 Seconds

Maintain Function Time:

(Time unit continues to operate after power is removed)

0.01 Seconds

Temperature: Operating: -28° to 65°C (-18° to 149°F)

Storage: -40° to 85°C (-40° to 185°F)

Output Contacts:

Normally Open Solid State 1A Continuous, 10A Inrush @ 65° C, Pilot Duty

Life:

No predictable failure if used within operating parameters.

Leakage Current (OFF-State): < 5ma @ 240V AC

Minimum Load Current: 20ma

Effective Voltage Drop (ON-State): Maximum 3V @ 1A for all voltages

Compatibility:

Using a solid state switch to initiate the time sequence is acceptable. See www.macromatic.com/leakage or contact Macromatic for information regarding leakage current limits and other solid state design considerations.

Mounting:

Surface with one #8 or #10 screw and a maximum tightening torque of 15 in-lbs.

Termination:

0.25" male quick-connect terminals

Approvals:



DIMENSIONS

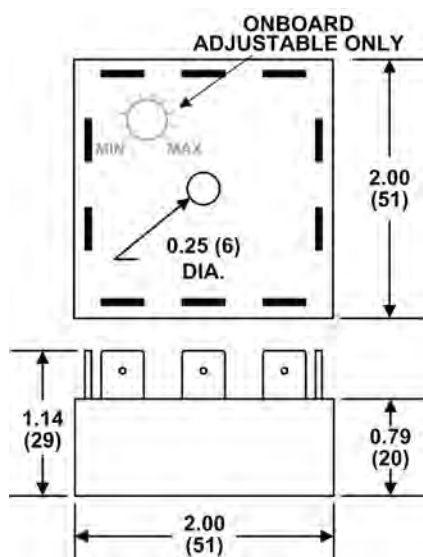

All Dimensions in Inches (Millimeters)

REMOTE TIME DELAY

THL-1 Series products can be built with two terminals for remote adjustable or fixed time delays. To order a product with a remote time delay, complete the Product Number by adding the two-digit Code from the Table shown on the appropriate product selection page followed by the suffix "R1", i.e., THL-1024U-30R1.

Adjustable Time Delay

A 100K ohm potentiometer is required to obtain the maximum time delay for all standard ranges. To use other values of remote potentiometers, contact Macromatic.

Fixed Time Delay

A fixed time delay can be set by connecting a resistor across the two terminals. To determine the resistor value required, use the following equation:

$$R = \frac{T}{T_{max}} \times 100,000$$

R = Resistance value required to obtain T
 T = Desired time delay
 T_{max} = Maximum time delay of range

Example: Using time range 0.1-10 seconds, what resistor value is required for a fixed time delay of 5 seconds:

$$R = \frac{5}{10} \times 100,000 = 50,000 \text{ ohms (50K ohms)}$$

ON DELAY | INLINE (SERIES CONNECTION)

SOLID STATE OUTPUT | DIP-SWITCH DIGITAL-SET | THL-8 SERIES



- ◆ Universal input voltage: 24-240V AC & 12-48V DC
- ◆ DIP-switch for accurate digital-set of any time delay from 100ms to 10,230 seconds
- ◆ Two-terminal series-connection with the load
- ◆ Cost effective design & compact 2" x 2" enclosure are ideal for volume OEM applications
- ◆ Microprocessor-based design for greater performance & maximum flexibility
- ◆ Encapsulated for protection against harsh environments
- ◆ Output rated 1A continuous/10A inrush pilot duty is perfect for high duty cycle/long life applications



The THL-8 On Delay Inline (Series Connection) offers an easy and accurate method to select any time delay. The THL-8 Series is a compact 2" x 2" encapsulated enclosure with a universal input voltage. It is connected in series with the load requiring only 2 terminals/connections.

Three time ranges are available: 0.1 – 102.3 seconds, 1 – 1,023 seconds and 10 – 10,230 seconds. Programming is accomplished through the use of a 10-position DIP-switch. Each position is marked with a binary time increment. The required delay is selected by moving the switch of each increment to the ON position and adding their corresponding values (see examples below). This method provides a greater setting accuracy than is found on other units with an analog potentiometer.

These products feature a universal input voltage of 24-240V AC and 12-48V DC. The inline two-terminal output is rated 1A continuous/10A inrush pilot duty, and is ideal for high duty cycle and long life applications. The enclosure is encapsulated for protection against harsh environments.

For similar products with choices of onboard and remote analog-set or fixed time delay, see the THL-1 Series.

FUNCTION ■	INPUT VOLTAGE	CATALOG NUMBER **	WIRING
ON DELAY A	24-240V AC & 12-48V DC	THL-8024U-**	<p>DIAGRAM 329</p>

■ See "Definitions of Timing Functions".

** Complete Product Number using two-digit Code from Table below.

TIME DELAYS

**TIMING RANGE TABLE	
COMPLETE PRODUCT NUMBER USING TWO DIGIT CODE BELOW: i.e., THL-8024U-40	
Time Delay Range	Code
0.1 - 102.3 Sec.	40
1 - 1,023 Sec.	41
10 - 10,230 Sec.	42

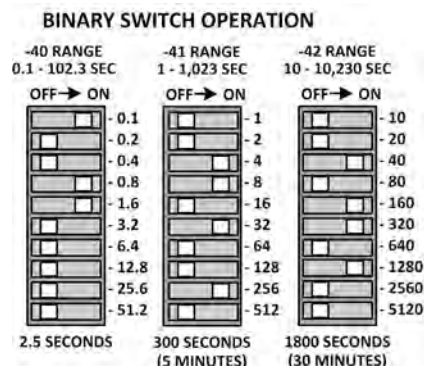

COMBINE FOR TOTAL TIME IN SECONDS



Better. By Design.

800.238.7474

WWW.MACROMATIC.COM

SALES@MACROMATIC.COM

Build your Time Delay Relays with the [Online Product Builder](#)

ON DELAY | INLINE (SERIES CONNECTION)

SOLID STATE OUTPUT | DIP-SWITCH DIGITAL-SET | THL-8 SERIES

APPLICATION DATA

Voltage Tolerance:

AC Operation: +10 to -15% of nominal voltage, 50/60 Hz $\pm 5\%$
 DC Operation: +10 to -15% of nominal voltage

Load (Burden): Maximum of 1 VA for all voltages

Setting Accuracy:

Constant Voltage & Temperature w/i specifications:

$\pm 2\%$ of set time or $\pm 50\text{ms}$, whichever is greater

For Variable Voltage & Temperature w/i specifications:

$\pm 5\%$ of set time or $\pm 50\text{ms}$, whichever is greater

Repeat Accuracy:

Constant Voltage & Temperature w/i specifications:

$\pm 0.1\%$ of set time or ± 0.02 seconds, whichever is greater

For Variable Voltage & Temperature w/i specifications:

$\pm 1\%$ of set time or ± 0.02 seconds, whichever is greater

Reset Time: 50ms

Start-up Time:

(Time from when power is applied until unit is timing)

0.02 Seconds

Maintain Function Time:

(Time unit continues to operate after power is removed)

0.01 Seconds

Temperature: Operating: -40° to 65°C (-40° to 149°F)

Storage: -40° to 85°C (-40° to 185°F)

Output Contacts:

Normally Open Solid State 1A Continuous, 10A Inrush @ 65°C , Pilot Duty

Life:

No predictable failure if used within operating parameters.

Leakage Current (OFF-State): $< 5\text{ma}$ @ 240V AC

Minimum Load Current: 20ma

Effective Voltage Drop (ON-State): Maximum 3V @ 1A for all voltages

Compatibility:

Using a solid state switch to initiate the time sequence is acceptable. See www.macromatic.com/leakage or contact Macromatic for information regarding leakage current limits and other solid state design considerations.

Mounting:

Surface with one #8 or #10 screw and a maximum tightening torque of 15 in-lbs.

Termination:

0.25" male quick-connect terminals

Approvals:



DIMENSIONS

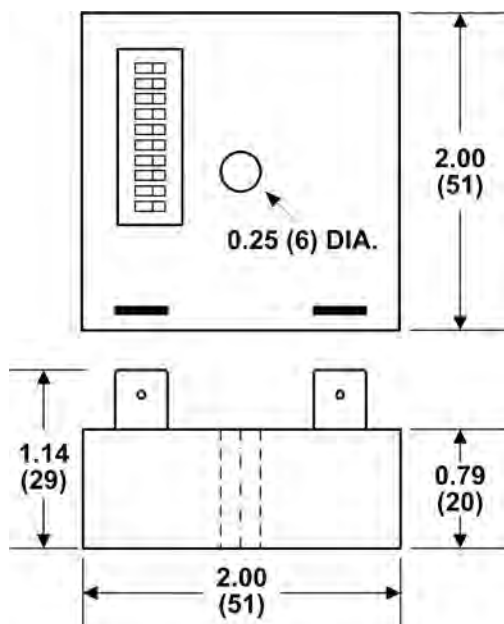

All Dimensions in Inches (Millimeters)

ON DELAY, INTERVAL, TRUE OFF DELAY & FLASHER

TR-5 SERIES



- ◆ Onboard & remote adjustable or fixed time delays from 0.05 seconds to 2 hours
- ◆ Uses industry-standard 8 pin octal sockets
- ◆ 10A DPDT output contacts
- ◆ Pilot duty rating



with appropriate socket

FUNCTION ■	INPUT VOLTAGE 50/60Hz.	CATALOG NUMBER **	WIRING/ SOCKETS ▲
ON DELAY A	120V AC/DC 12V DC 24V AC/DC 240V AC	TR-50222-** TR-50226-** TR-50228-** TR-50221-**	8 PIN OCTAL 70169-D DIAGRAM 1
INTERVAL ON B	120V AC/DC 12V DC 24V AC/DC 240V AC	TR-50522-** TR-50526-** TR-50528-** TR-50521-**	
TRUE OFF DELAY R	120V AC/DC 12V DC 24V AC/DC 240V AC	TR-50622-** TR-50626-** TR-50628-** TR-50621-**	
FLASHER (OFF 1st) E	120V AC/DC 12V DC 24V AC/DC 240V AC	TR-50822-** TR-50826-** TR-50828-** TR-50821-**	

■ See "Definitions of Timing Functions".

** Complete Product Number using two-digit Code from Table below.

▲ Note: If these products are ordered with the Remote Adjustable Time Delay modification (suffix -Rx), they will require an 11 pin octal socket—see www.macromatic.com/remote for information. Remote Adjustable Time Delay not available on TR-506 products.

TIME DELAY RELAYS | PLUG-IN



Better. By Design.

800.238.7474

WWW.MACROMATIC.COM

SALES@MACROMATIC.COM

TIME DELAYS

TR-5 Series Products have three time delay options:

- **Onboard Adjustable Time Delay**--complete Product Number by adding two-digit Code from Table at right, i.e., TR-50222-05 is an On Delay with a time delay range of 0.1-10 seconds.
- **Onboard Fixed Time Delay**--replace two-digit Code with suffix "F" followed by delay [0.1 ... 100] followed by (S) seconds, (M) minutes or (H) hours, i.e., TR-50222-F5S is an On Delay with a time delay fixed at 5 seconds.
- **Remote Adjustable Time Delay**--Selected TR-5 Series products can be built with two terminals for remote adjustable or fixed time delays. See www.macromatic.com/remote for information.

** TIMING RANGE TABLE

Time Delay Range	Code
0.05 - 5 Sec.	04
0.1 - 10 Sec.	05
0.3 - 30 Sec.	07*
0.6 - 60 Sec.	08
1.2 - 120 Sec.	09
1.8 - 180 Sec.	10
3 - 300 Sec.	12
0.1 - 10 Min.	22
0.3 - 30 Min.	15
0.6 - 60 Min.	16*
1.2 - 120 Min.	17*

* Not offered on TR-506

Sockets & Accessories available

Build your Time Delay Relays with the [Online Product Builder](#)

OFF DELAY, SINGLE SHOT, WATCHDOG & SINGLE SHOT FALLING EDGE

TR-5 SERIES

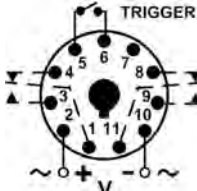
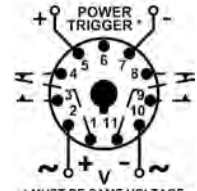
FUNCTION ■ ▲	INPUT VOLTAGE 50/60Hz.	CATALOG NUMBER **	WIRING/ SOCKETS ▲
ON DELAY Switch Trigger	120V AC/DC 12V DC 24V AC/DC 240V AC	TR-51222-** TR-51226-** TR-51228-** TR-51221-**	11 PIN OCTAL 70170-D  DIAGRAM 2
OFF DELAY Control Switch Trigger C	120V AC/DC 12V DC 24V AC/DC 240V AC	TR-51622-** TR-51626-** TR-51628-** TR-51621-**	
SINGLE SHOT Control Switch Trigger D	120V AC/DC 12V DC 24V AC/DC 240V AC	TR-51522-** TR-51526-** TR-51528-** TR-51521-**	
WATCHDOG Control Switch Trigger (Retriggerable Single Shot) J	120V AC/DC 12V DC 24V AC/DC 240V AC	TR-51322-** TR-51326-** TR-51328-** TR-51321-**	
SINGLE SHOT FALLING EDGE Control Switch Trigger H	120V AC/DC 12V DC 24V AC/DC 240V AC	TR-52222-** TR-52226-** TR-52228-** TR-52221-**	11 PIN OCTAL 70170-D  DIAGRAM 4
OFF DELAY Power Trigger C	120V AC/DC 12V DC 24V AC/DC 240V AC	TR-51922-** TR-51926-** TR-51928-** TR-51921-**	
SINGLE SHOT Power Trigger D	120V AC/DC 12V DC 24V AC/DC 240V AC	TR-51722-** TR-51726-** TR-51728-** TR-51721-**	
WATCHDOG Power Trigger (Retriggerable Single Shot) J	120V AC/DC 12V DC 24V AC/DC 240V AC	TR-51822-** TR-51826-** TR-51828-** TR-51821-**	

■ See "Definitions of Timing Functions".

** Complete Product Number using two-digit Code from Table below.

▲ 8 Pin SPDT versions of these functions (except Single Shot Falling Edge) are available.

TIME DELAYS

TR-5 Series Products have three time delay options:

- **Onboard Adjustable Time Delay**--complete Product Number by adding two-digit Code from Table at right, i.e., TR-51622-05 is an Off Delay with a time delay range of 0.1-10 seconds.
- **Onboard Fixed Time Delay**--replace two-digit Code with suffix "F" followed by delay [0.1 ... 100] followed by (S) seconds, (M) minutes or (H) hours, i.e., TR-51622-F5S is an Off Delay with a time delay fixed at 5 seconds.
- **Remote Time Delay**--Selected TR-5 Series products can be built with two terminals for remote adjustable or fixed time delays. See www.macromatic.com/remote for information.

** TIMING RANGE TABLE

Time Delay Range	Code
0.05 - 5 Sec.	04
0.1 - 10 Sec.	05
0.3 - 30 Sec.	07
0.6 - 60 Sec.	08
1.2 - 120 Sec.	09
1.8 - 180 Sec.	10
3 - 300 Sec.	12
0.1 - 10 Min.	22
0.3 - 30 Min.	15
0.6 - 60 Min.	16
1.2 - 120 Min.	17

Sockets & Accessories available

Build your Time Delay Relays with the [Online Product Builder](#)



- ◆ Onboard & remote adjustable or fixed time delays from 0.05 seconds to 2 hours
- ◆ Uses industry-standard 11 pin octal sockets
- ◆ 10A DPDT output contacts
- ◆ Pilot duty rating



with appropriate socket

TIME DELAY RELAYS | PLUG-IN



Better. By Design.

800.238.7474

WWW.MACROMATIC.COM
SALES@MACROMATIC.COM

REPEAT CYCLE, ON/OFF DELAY, & DELAYED INTERVAL

TR-5 SERIES



- ◆ Onboard & remote adjustable or fixed time delays from 0.05 seconds to 2 hours
- ◆ Independently adjustable ON & OFF times
- ◆ Uses industry-standard 8 or 11 pin octal sockets
- ◆ 10A DPDT output contacts
- ◆ Pilot duty rating



with appropriate socket

FUNCTION ■	INPUT VOLTAGE 50/60Hz.	CATALOG NUMBER **	WIRING/SOCKET
REPEAT CYCLE* (OFF Time First Followed By ON Time and Repeating) L	120V AC/DC 12V DC 24V AC/DC 240V AC	TR-53122-** TR-53126-** TR-53128-** TR-53121-**	8 PIN OCTAL 70169-D DIAGRAM 1
ON/TRUE OFF DELAY S	120V AC/DC 12V DC 24V AC/DC 240V AC	TR-54622-** TR-54626-** TR-54628-** TR-54621-**	
REPEAT CYCLE* (ON Time First Followed By OFF Time and Repeating) M	120V AC/DC 12V DC 24V AC/DC 240V AC	TR-55122-** TR-55126-** TR-55128-** TR-55121-**	
DELAYED INTERVAL* (OFF Time Followed by ON Time Followed by OFF State Until Reset) N	120V AC/DC 12V DC 24V AC/DC 240V AC	TR-56122-** TR-56126-** TR-56128-** TR-56121-**	
ON/OFF DELAY* Control Switch Trigger G	120V AC/DC 12V DC 24V AC/DC 240V AC	TR-54122-** TR-54126-** TR-54128-** TR-54121-**	11 PIN OCTAL 70170-D DIAGRAM 2
DELAYED INTERVAL* Control Switch Trigger (OFF Time Followed by ON Time Followed by OFF State Until Reset) P	120V AC/DC 12V DC 24V AC/DC 240V AC	TR-56522-** TR-56526-** TR-56528-** TR-56521-**	

■ See "Definitions of Timing Functions".

* ON & OFF Time Ranges for these functions are the same. See www.macromatic.com/onoff for information on how to order a unit with different ON & OFF time ranges.

** Complete Product Number using two-digit Code from Table below.

TIME DELAYS

TR-5 Series Products have three time delay options:

- **Onboard Adjustable Time Delay**--complete Product Number by adding two-digit Code from Table at right, i.e., TR-53122-05 is a Repeat Cycle with both an ON & OFF time delay range of 0.1-10 seconds. See www.macromatic.com/onoff for information on how to order a unit with different ON & OFF time ranges.
- **Onboard Fixed Time Delay**--replace two-digit Code with suffix "F" followed by delay [0.1 ... 100] followed by (S) seconds, (M) minutes or (H) hours, i.e., TR-53122-F5S is a Repeat Cycle with a time delay fixed at 5 seconds.
- **Remote Time Delay**--Selected TR-5 Series products can be built with two terminals for remote adjustable or fixed time delays. See www.macromatic.com/remotec for information.

** TIMING RANGE TABLE

Time Delay Range	Code
0.05 - 5 Sec.	04
0.1 - 10 Sec.	05
0.3 - 30 Sec.	07*
0.6 - 60 Sec.	08
1.2 - 120 Sec.	09
1.8 - 180 Sec.	10
3 - 300 Sec.	12
0.1 - 10 Min.	22
0.3 - 30 Min.	15
0.6 - 60 Min.	16*
1.2 - 120 Min.	17*

* Not offered on TR-546

Sockets & Accessories available

Build your Time Delay Relays with the [Online Product Builder](#)



Better. By Design.

800.238.7474

WWW.MACROMATIC.COM

SALES@MACROMATIC.COM

TR-5 SERIES

APPLICATION DATA

Voltage Tolerance:

AC Operation: +10/-15% of nominal at 50/60 Hz.
 DC Operation: +10/-15% of nominal.

Load (Burden):

Maximum of 2 VA for all voltages

Setting Accuracy:

Maximum Setting (Adjustable): +5%, -0%
 Minimum Setting (Adjustable): +0%, -50%
 Fixed Time Delay: ±2% or 50ms, whichever is greater

Repeat Accuracy (constant voltage and temperature):

±0.1% or ± 0.04 seconds, whichever is greater

Reset Time:

Input Voltage (All Functions)	0.100 Seconds
Triggered Functions only	0.04 Seconds

Start-up Time:

(Time from when power is applied until unit is timing)

0.05 Seconds

Maintain Function Time:

(Time unit continues to operate after power is removed)

0.01 Seconds for all units

Temperature: Operating: -28° to 65°C (-18° to 149°F)
 Storage: -40° to 85°C (-40° to 185°F)

Output Contacts:

(All TR-5 Series Products except TR-506 & TR-546)
 DPDT 10A @ 240V AC/30V DC,
 1/2HP @ 120/240V AC (N.O.), 1/3HP @ 120/240V AC (N.C.)
 B300 & R300; AC15 & DC13

(TR-506 & TR-546)

DPDT 10A @ 240V AC; 8A @ 28V DC,
 1/2 HP @ 240V AC, 1/4HP @ 120V AC
 B300 & R300

Life:

Mechanical: 10,000,000 operations (2,000,000 operations on TR-506 & TR-546 Series only)
 Full Load: 100,000 operations

Compatibility:

Using a solid state switch to initiate the time sequence is acceptable. See www.macromatic.com/leakage or contact Macromatic for information regarding leakage current limits and other solid state design considerations.

Triggering Off Delay, Single Shot or Watchdog Units:

Timing sequence must be initiated only after input voltage is applied to unit. Minimum required trigger switch closure time is 0.05 seconds.

IMPORTANT FOR TR-506 & TR-546 SERIES ONLY: These relays are shipped from the factory in the OFF state. A shock to the relay during shipping or installation may cause it to change to the ON state. It is recommended that input voltage be applied to the product for at least 0.1 second and removed to cycle the unit to the OFF state prior to use in the application. Please note that it will take as long as the OFF Delay setting to reset the unit once input voltage has been removed.

Approvals:

(All TR-5 Series Products except TR-506 & TR-546)



File #E109466

File #LR45565

(TR-506 & TR-546 only)



File #E109466

(All TR-5 Series Products)



Low Voltage & EMC Directives
 EN60947-1, EN60947-5-1



IND. CONT. EQUIP. SOCKET
 with appropriate socket
 File #E109466

DIMENSIONS

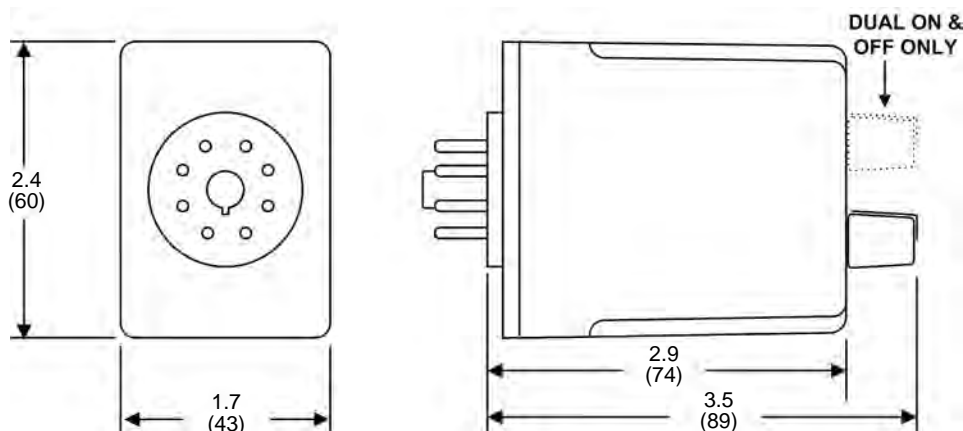

All Dimensions in Inches (Millimeters)

MULTI-RANGE ON DELAY, INTERVAL ON & FLASHER

TR-6 SERIES TIME RANGER™

The TR-6 Series offers the flexible programmability of a multi-range time delay relay together with a universal input voltage. These products provide an easy method to select one of 16 time ranges between 0.05 seconds and 100 hours using a rotary switch. The actual time delay is then set by using the potentiometer to adjust within the selected time range.



- ◆ Each unit has 16 timing ranges built-in covering 0.05 seconds-100 hours
- ◆ Selecting a range is easy using a rotary switch (no math is required or DIP switches to set)
- ◆ Universal input voltage: 24-240V AC & 12-125V DC
- ◆ Uses industry-standard 8 pin octal sockets
- ◆ 10A DPDT output contacts can handle most pilot duty & fractional HP loads



Better. By Design.

800.238.7474
WWW.MACROMATIC.COM
SALES@MACROMATIC.COM

FUNCTION ■	INPUT VOLTAGE 50/60Hz.	CATALOG NUMBER	WIRING/ SOCKETS
ON DELAY A	24-240V AC & 12-125V DC	TR-6022U	<p>DIAGRAM 1</p>
INTERVAL ON B	24-240V AC & 12-125V DC	TR-6052U	
FLASHER (OFF 1st) E	24-240V AC & 12-125V DC	TR-6082U	
FLASHER (ON 1st) F	24-240V AC & 12-125V DC	TR-6092U	

■ See "Definitions of Timing Functions".

TIMING RANGES

Select one of the 16 built-in time ranges by setting the rotary switch per a chart on the unit (see below) and then adjust within that range using the knob on top.

Dial Setting	Timing Range
A	0.05 - 0.5 Sec.
B	0.1 - 1 Sec.
C	0.5 - 5 Sec.
D	1 - 10 Sec.
E	3 - 30 Sec.
F	6 - 60 Sec.
G	0.2 - 2 Min.
H	0.5 - 5 Min.
I	1 - 10 Min.
J	3 - 30 Min.
K	6 - 60 Min.
L	0.2 - 2 Hr.
M	0.5 - 5 Hr.
N	1 - 10 Hr.
O	2.4 - 24 Hr.
P	10 - 100 Hr.

Sockets & Accessories available

Build your Time Delay Relays with the [Online Product Builder](#)

MULTI-RANGE OFF DELAY, SINGLE SHOT & WATCHDOG TR-6 SERIES TIME RANGER™

The TR-6 Series offers the flexible programmability of a multi-range time delay relay together with a universal input voltage. These products provide an easy method to select one of 16 time ranges between 0.05 seconds and 100 hours using a rotary switch. The actual time delay is then set by using the potentiometer to adjust within the selected time range.

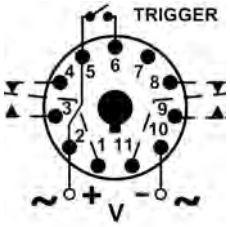
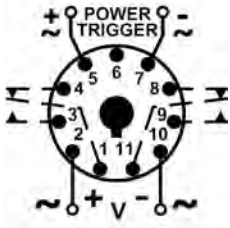
FUNCTION ■	INPUT VOLTAGE 50/60Hz.	CATALOG NUMBER	WIRING/SOCKETS
OFF DELAY ▲ Control Switch Trigger C	24-240V AC & 12-125V DC	TR-6162U	 <p>DIAGRAM 212</p>
SINGLE SHOT Control Switch Trigger D	24-240V AC & 12-125V DC	TR-6152U	
WATCHDOG Control Switch Trigger (Retriggerable Single Shot) J	24-240V AC & 12-125V DC	TR-6132U	
OFF DELAY ▲ Power Trigger C	24-240V AC & 12-125V DC	TR-6192U	 <p>DIAGRAM 216</p>
SINGLE SHOT Power Trigger D	24-240V AC & 12-125V DC	TR-6172U	
WATCHDOG Power Trigger (Retriggerable Single Shot) J	24-240V AC & 12-125V DC	TR-6182U	

■ See "Definitions of Timing Functions".
▲ See TR-606 Series for True Off Delay function.

TIMING RANGES

Select one of the 16 built-in time ranges by setting the rotary switch per a chart on the unit (see below) and then adjust within that range using the knob on top.

Dial Setting	Timing Range
A	0.05 - 0.5 Sec.
B	0.1 - 1 Sec.
C	0.5 - 5 Sec.
D	1 - 10 Sec.
E	3 - 30 Sec.
F	6 - 60 Sec.
G	0.2 - 2 Min.
H	0.5 - 5 Min.
I	1 - 10 Min.
J	3 - 30 Min.
K	6 - 60 Min.
L	0.2 - 2 Hr.
M	0.5 - 5 Hr.
N	1 - 10 Hr.
O	2.4 - 24 Hr.
P	10 - 100 Hr.

Sockets & Accessories available



- ◆ Each unit has 16 timing ranges built-in covering 0.05 seconds-100 hours
- ◆ Selecting a range is easy using a rotary switch (no math is required or DIP switches to set)
- ◆ Universal input voltage: 24-240V AC & 12-125V DC
- ◆ Uses industry-standard 11 pin octal sockets
- ◆ 10A DPDT output contacts can handle most pilot duty & fractional HP loads



Better. By Design.

800.238.7474

WWW.MACROMATIC.COM
SALES@MACROMATIC.COM

Build your Time Delay Relays with the [Online Product Builder](#)

MULTI-RANGE REPEAT CYCLE & DELAYED INTERVAL

TR-6 SERIES TIME RANGER™

The TR-6 Series offers the flexible programmability of a multi-range time delay relay together with a universal input voltage. These products provide an easy method to select one of 16 time ranges between 0.05 seconds and 100 hours using a rotary switch. The actual time delay is then set by using the potentiometer to adjust within the selected time range.



- ◆ Each unit has 16 timing ranges built-in covering 0.05 seconds-100 hours
- ◆ Selecting a range is easy using a rotary switch (no math is required or DIP switches to set)
- ◆ Independently selectable & adjustable ON & OFF times
- ◆ Universal input voltage: 24-240V AC & 12-125V DC
- ◆ Uses industry-standard 8 or 11 pin octal sockets
- ◆ 10A DPDT output contacts can handle most pilot duty & fractional HP loads



Better. By Design.

800.238.7474

WWW.MACROMATIC.COM

SALES@MACROMATIC.COM

FUNCTION ■	INPUT VOLTAGE 50/60Hz.	CATALOG NUMBER	WIRING/SOCKET
REPEAT CYCLE* (OFF Time First Followed By ON Time and Repeating) L	24-240V AC & 12-125V DC	TR-6312U	8 PIN OCTAL 70169-D
REPEAT CYCLE* (ON Time First Followed By OFF Time and Repeating) M	24-240V AC & 12-125V DC	TR-6512U	 DIAGRAM 1
DELAYED INTERVAL* (OFF Time Followed by ON Time Followed by OFF State Until Reset) N	24-240V AC & 12-125V DC	TR-6612U	
DELAYED INTERVAL* Control Switch Trigger (OFF Time Followed by ON Time Followed by OFF State Until Reset) P	24-240V AC & 12-125V DC	TR-6652U	 DIAGRAM 212

* These units have independently selectable & adjustable ON & OFF times. See www.macromatic.com/onoff for more information.

■ See "Definitions of Timing Functions".

TIMING RANGES

Select one of the 16 built-in time ranges by setting the rotary switch per a chart on the unit (see below) and then adjust within that range using the knob on top.

Dial Setting	Timing Range
A	0.05 - 0.5 Sec.
B	0.1 - 1 Sec.
C	0.5 - 5 Sec.
D	1 - 10 Sec.
E	3 - 30 Sec.
F	6 - 60 Sec.
G	0.2 - 2 Min.
H	0.5 - 5 Min.
I	1 - 10 Min.
J	3 - 30 Min.
K	6 - 60 Min.
L	0.2 - 2 Hr.
M	0.5 - 5 Hr.
N	1 - 10 Hr.
O	2.4 - 24 Hr.
P	10 - 100 Hr.

Sockets & Accessories available

Build your Time Delay Relays with the [Online Product Builder](#)

MULTI-RANGE

TR-6 SERIES TIME RANGER™

APPLICATION DATA

Voltage Tolerance:

AC Operation: 20.4 – 264V at 50/60 Hz
 DC Operation: 10.2 – 137.5V

Load (Burden):

Maximum of 3 VA for all voltages

Setting Accuracy:

Maximum Setting (Adjustable): +5%, -0%
 Minimum Setting (Adjustable): +0%, -50%

Repeat Accuracy (constant voltage and temperature):

±0.1% or ±50ms, whichever is greater

Reset Time:

Functions Triggered with Input Voltage: 0.1 Seconds
 Functions Triggered with Control Switch: 0.04 Seconds

Start-up Time:

(Time from when power is applied until unit is timing)
 0.05 Seconds

Maintain Function Time:

(Time unit continues to operate after power is removed)
 0.01 Seconds

Temperature:

Operating: -28° to 65°C (-18° to 150°F)
 Storage: -40° to 85°C (-40° to 185°F)

Triggering Off Delay, Single Shot or Watchdog Units:

Timing sequence must be initiated only after input voltage is applied to unit. Minimum required trigger switch closure time is 0.1 seconds.

Compatibility:

Using a solid state switch to initiate the time sequence is acceptable. See www.macromatic.com/leakage or contact Macromatic for information regarding leakage current limits and other solid state design considerations.

Output Contacts:

DPDT 10A @ 240V AC/30V DC,
 1/2HP @ 120/240V AC (N.O.), 1/3HP @ 120/240V AC (N.C.)
 B300 & R300 (N.O.); AC15 & DC13

Life:

Mechanical: 10,000,000 operations
 Full Load: 100,000 operations

Approvals:



Low Voltage & EMC Directives
 EN60947-1, EN60947-5-1

DIMENSIONS

TR-602, TR-605, TR608, TR609, TR-613, TR-615, TR-616, TR-617, TR-618 & TR-619

TR-631-TR-651, TR-661 & TR-665

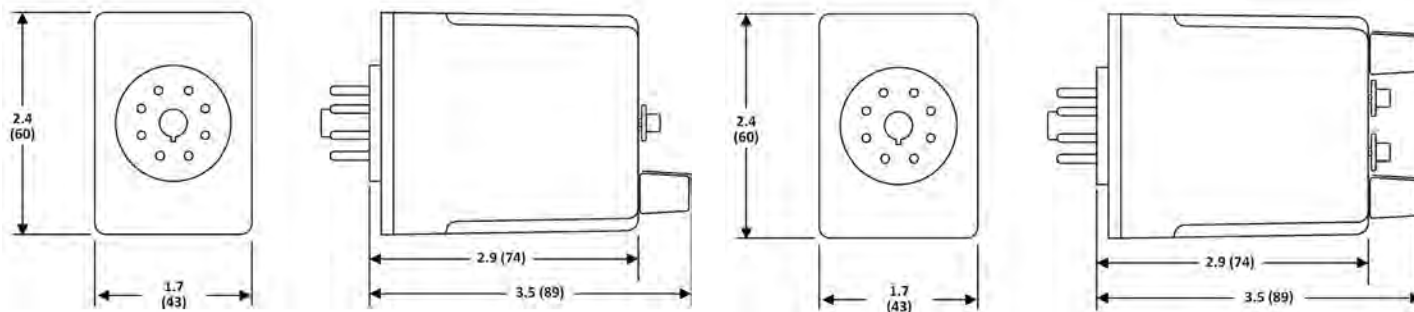

All Dimensions in Inches (Millimeters)

MULTI-RANGE TRUE OFF DELAY

TR-6 SERIES TIME RANGER™



- ◆ Each unit has 8 timing built-in covering 0.05 seconds - 30 minutes
- ◆ Selecting a range is easy using a rotary switch (no math is required or DIP switches to set)
- ◆ Uses industry-standard 8 pin octal sockets
- ◆ 10A DPDT output contacts can handle most pilot duty & fractional HP loads



A True Off Delay time delay relay is designed to replace the functionality of pneumatic time delay relays which are very large, expensive and not very accurate. Unlike standard electronic Off Delay time delay relays (see page 29), a True Off Delay does not require a trigger switch or the continuous application of input voltage. Instead, these products keep the logic circuit and relay energized during the Off Delay (Delay on De-energization) period with an onboard power source.

The Macromatic TR-606 Series is a perfect product to use when a trigger switch is not available in the circuit or when the application is to replace the functionality of a pneumatic time delay relay. These products come with 8 separate timing ranges covering 0.5 seconds – 30 minutes which are easy to select & setup with one rotary switch & potentiometer.

Operation: Upon application of input voltage, the output is energized. When the input voltage is removed, the time delay (t) begins. At the end of the time delay (t), the output is de-energized.

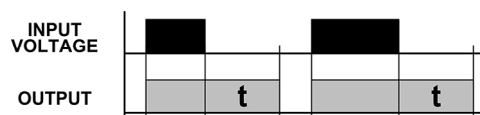

Input voltage must be applied for a minimum of 0.5 seconds to assure proper operation. Any application of the input voltage during the time delay (t) will reset the time delay. No external trigger is required.

FUNCTION ■	INPUT VOLTAGE 50/60Hz.	CATALOG NUMBER	WIRING/SOCKETS
TRUE OFF DELAY	120V AC/DC 12V DC 24V AC/DC 240V AC 48V AC/DC	TR-60622 TR-60626 TR-60628 TR-60621 TR-60624	8 PIN OCTAL 70169-D DIAGRAM 1

■ See “Definitions of Timing Functions”.

TIMING RANGES

Select one of the 8 built-in time ranges by setting the rotary switch per a chart on the unit (see below) and adjust within that range using the knob on top:

Dial Setting	Timing Range
A	0.05 - 5 Sec.
B	0.1 - 10 Sec.
C	0.3 - 30 Sec.
D	0.6 - 60 Sec.
E	1.8 - 180 Sec.
F	3 - 300 Sec.
G	0.1 - 10 Min.
H	0.3 - 30 Min.

Sockets & Accessories available

Build your Time Delay Relays with the [Online Product Builder](#)



Better. By Design.

800.238.7474

WWW.MACROMATIC.COM

SALES@MACROMATIC.COM

PROGRAMMABLE | MULTI-FUNCTION

TR-6 SERIES TIME RANGER™

The TR-681 & TR-682 Series offer the flexible programmability of a multi-function and multi-range time delay relay together with a universal input voltage. These products provide an easy method to select one of eight (TR-681) or four (TR-682) time delay functions and any time range between 0.05 seconds and 100 hours. Programming is accomplished through the use of two rotary switches to select function and time range. The actual time delay is then set by using the potentiometer to adjust within the selected time range. This product can literally replace hundreds of different catalog numbers, thereby reducing inventory requirements.

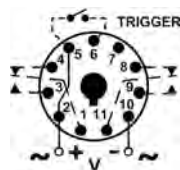
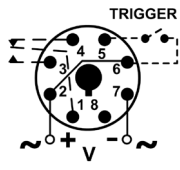
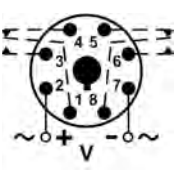
FUNCTION ■	OUTPUT	INPUT VOLTAGE 50/60Hz.	CATALOG NUMBER	WIRING/SOCKETS
ON DELAY INTERVAL ON OFF DELAY SINGLE SHOT FLASHER (ON 1st) SINGLE SHOT (Falling Edge) WATCHDOG ON DELAY (Triggered)	11 Pin DPDT	24-240V AC & 12-125V DC	TR-6812U	11 PIN OCTAL 70170-D  DIAGRAM 210
	8 Pin SPDT	24-240V AC & 12-125V DC	TR-6816U	8 PIN OCTAL 70169-D  DIAGRAM 211
ON DELAY INTERVAL ON FLASHER (OFF 1st) FLASHER (ON 1st)	8 Pin DPDT	24-240V AC & 12-125V DC	TR-6822U	8 PIN OCTAL 70169-D  DIAGRAM 1

■ See "Definitions of Timing Functions".

TIMING RANGES

Select one of the 16 built-in time ranges by setting the rotary switch per a chart on the unit (see right) and then adjust within that range using the knob on top.

Dial Setting	Timing Range	Dial Setting	Timing Range
A	0.05 - 0.5 Sec.	I	1 - 10 Min.
B	0.1 - 1 Sec.	J	3 - 30 Min.
C	0.5 - 5 Sec.	K	6 - 60 Min.
D	1 - 10 Sec.	L	0.2 - 2 Hr.
E	3 - 30 Sec.	M	0.5 - 5 Hr.
F	6 - 60 Sec.	N	1 - 10 Hr.
G	0.2 - 2 Min.	O	2.4 - 24 Hr.
H	0.5 - 5 Min.	P	10 - 100 Hr.

Sockets & Accessories available

Build your Time Delay Relays with the [Online Product Builder](#)



- ◆ Four or eight timing functions in one unit easily selectable with rotary switch
- ◆ Each unit has 16 timing ranges built-in covering 0.05 seconds-100 hours
- ◆ Selecting a range is easy using a 16-position rotary switch (no math is required or DIP switches to set)
- ◆ Universal input voltage: 24-240V AC & 12-125V DC
- ◆ Utilizes industry-standard 8 or 11 pin octal sockets
- ◆ 10A SPDT or DPDT output contacts can handle most pilot duty and fractional HP loads



Better. By Design.

800.238.7474

WWW.MACROMATIC.COM
SALES@MACROMATIC.COM

PROGRAMMABLE | MULTI-FUNCTION

TR-6 SERIES TIME RANGER™

PROGRAMMING FUNCTION & TIME DELAY

Setting Function: To set the function, first select one of the eight (TR-681 Series) or four (TR-682 Series) functions from the Select Function Chart located on the side of the relay (see right). Position the eight-position rotary switch to the number that corresponds to the desired function. **NOTE:** Because the TR-682 Series comes with only four functions, but uses an eight-position rotary switch to select a function, each function can be selected with the same number in two positions. **NOTE:** Function cannot be changed with power applied to unit.

Setting Time Delay and Time Range: To set the desired time delay, first select one of the 16 time ranges from the Timing Range Chart located on the side of the relay. Position the rotary switch to the letter that corresponds to the desired time range. Then adjust the time delay within the selected time range by rotating the large knob of the potentiometer located on top of the unit. **Note:** The tick marks are for reference only.

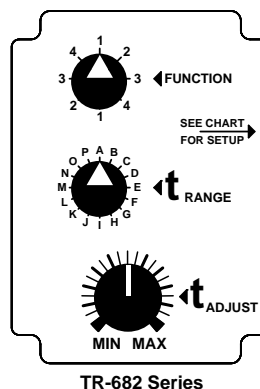
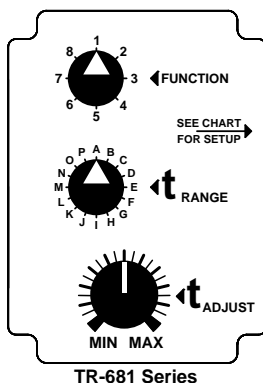

TR-681 Series

Select Function	
1	On Delay
2	Interval On
3	Flasher - On 1st
4	Triggered On Delay
5	Watchdog
6	Single Shot
7	Off Delay
8	One Shot Falling Edge

TR-682 Series

Select Function	
1	On Delay
2	Interval On
3	Flasher - Off 1st
4	Flasher - On 1st

APPLICATION DATA

Voltage Tolerance:

AC Operation: 20.4 – 264V at 50/60 Hz
DC Operation: 10.2 – 137.5V

Load (Burden):

Maximum of 3 VA for all voltages

Setting Accuracy:

Maximum Setting (Adjustable): +5%, -0%
Minimum Setting (Adjustable): +0%, -50%

Repeat Accuracy (constant voltage and temperature):

±0.1% or ±50ms, whichever is greater

Reset Time:

Functions Triggered with Input Voltage: 0.1 Seconds
Functions Triggered with Control Switch: 0.04 Seconds

Start-up Time: (Time from when power is applied until unit is timing): 50ms

Maintain Function Time: (Time unit continues to operate after power is removed): 0.01 Seconds

Temperature:

Operating: -28° to 65°C (-18° to 150°F)
Storage: -40° to 85°C (-40° to 185°F)

Functions Triggered By A Control Switch:

Minimum required trigger switch closure time is 50ms.

Compatibility:

Using a solid state switch to initiate the time sequence is acceptable. See www.macromatic.com/leakage or contact Macromatic for information regarding leakage current limits and other solid state design considerations.

Output Contacts:

10A @ 240V AC/30V DC,
1/2HP @ 120/240V AC (N.O.), 1/3HP @ 120/240V AC (N.C.)
B300 & R300 (N.O.); AC15 & DC13

Life:

Mechanical: 10,000,000 operations
Full Load: 100,000 operations

Approvals:



Low Voltage & EMC Directives
EN60947-1, EN60947-5-1

DIMENSIONS

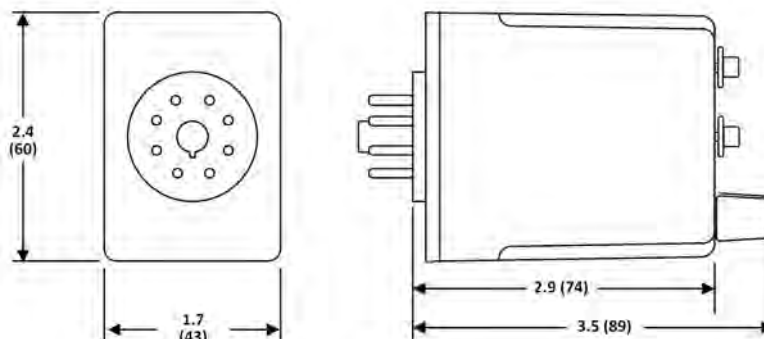

All Dimensions in Inches (Millimeters)

PROGRAMMABLE | MULTI-RANGE TRUE OFF DELAY

TR-6 SERIES TIME RANGER™

APPLICATION DATA

Voltage Tolerance:

AC Operation: +10/-15% of nominal at 50/60 Hz
DC Operation: +10/-15% of nominal

Load (Burden):

Maximum of 2 VA for all voltages. These products draw a brief inrush current on power-up of 1A to charge the internal circuitry.

Setting Accuracy:

Maximum Setting (Adjustable): +5%, -0%
Minimum Setting (Adjustable): +0%, -50%

Repeat Accuracy (constant voltage and temperature):
±50ms

Reset Time: 0.1 Seconds

Start-up Time:

(Time from when power is applied until unit is timing)
0.05 Seconds

Maintain Function Time:

(Time unit continues to operate after power is removed)
0.01 Seconds for all units

Temperature:

-28° to 65°C (-18° to 150°F)

Compatibility:

Using a solid state switch to initiate the time sequence is acceptable. See www.macromatic.com/leakage or contact Macromatic for information regarding leakage current limits and other solid state design considerations.

Output Contacts:

DPDT 10A @ 240V AC; 8A @ 28V DC,
1/2 HP @ 240V AC, 1/4HP @ 120V AC
B300 & R300

Life:

Mechanical: 2,000,000 operations
Full Load: 100,000 operations

IMPORTANT: These relays are shipped from the factory in the OFF state. A shock to the relay during shipping or installation may cause it to change to the ON state. It is recommended that input voltage be applied to the product for at least 0.1 second and removed to cycle the unit to the OFF state prior to use in the application. Please note that it will take as long as the OFF Delay setting to reset the unit once input voltage has been removed.

Approvals:



DIMENSIONS

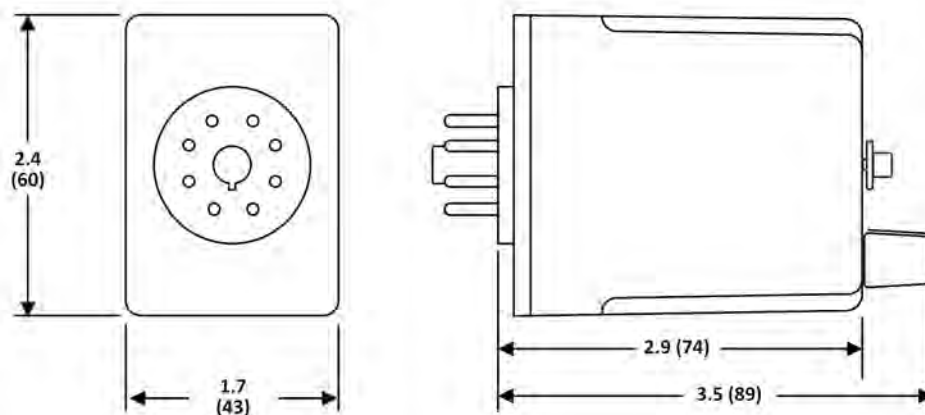

All Dimensions in Inches (Millimeters)

PROGRAMMABLE | MULTI-RANGE

DIGITAL-SET | TD-7 SERIES TIME RANGER™

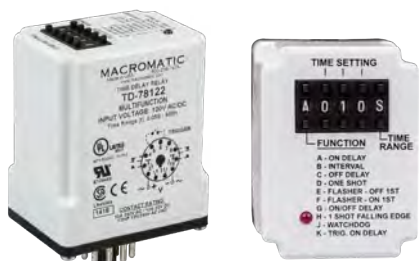

- ◆ Ten user-selectable modes in one unit
- ◆ Pushbutton Thumbwheels for digital set of time delay & function
- ◆ 50ms - 999 hour programmable time range
- ◆ Uses industry-standard 11 pin octal socket
- ◆ 10A DPDT output contacts
- ◆ LED indicates timing mode and time out conditions
- ◆ Pilot duty rating



with appropriate socket



Better. By Design.

800.238.7474

WWW.MACROMATIC.COM

SALES@MACROMATIC.COM

The TD-781 Series offers an easy and accurate way to select a function and any time delay between 50ms and 999 hours. Programming is accomplished by using a pushbutton thumbwheel to select one of seven built-in time ranges and three pushbutton thumbwheels to digitally set the time delay required. This method provides a greater setting accuracy than is found on other units with an analog potentiometer. These units have a fifth pushbutton thumbwheel to select one of ten built-in functions. An LED indicates timing mode and time out condition.

Single-function versions available.

Multi-Function Product

FUNCTION ■	INPUT VOLTAGE	CATALOG NUMBER	WIRING/SOCKETS
MULTI-FUNCTION (10 Functions in One Unit)	120V AC/DC	TD-78122	11 PIN OCTAL
On Delay	12V DC	TD-78126	70170-D
Interval On	24V AC/DC	TD-78128	
Off Delay *	240V AC	TD-78121	
Single Shot *			
Flasher (OFF 1st)			
Flasher (ON 1st)			
On/Off Delay *			
Single Shot Falling Edge *			
Watchdog *			
Triggered On Delay *			

DIAGRAM 121

■ See "Definitions of Timing Functions".

* These are the only functions requiring use of the Control Switch shown in Wiring Diagrams above.

Sockets & Accessories available

Build your Time Delay Relays with the **Online Product Builder**

PROGRAMMABLE | MULTI-RANGE

DIGITAL-SET | TD-7 SERIES TIME RANGER™

The TD-7 series of time delay relays offer an easy and accurate way to select any time delay between 50ms and 999 hours. Programming is accomplished by using a pushbutton thumbwheel to select one of seven built-in time ranges and three pushbutton thumbwheels to digitally set the time delay required. This method provides a greater setting accuracy than is found on other units with an analog potentiometer. An LED indicates timing mode and time out condition.

Multi-function versions available.

Single Function Products

FUNCTION ■	INPUT VOLTAGE	CATALOG NUMBER	WIRING/ SOCKETS
ON DELAY	120V AC/DC 12V DC 24V AC/DC 240V AC	TD-70222 TD-70226 TD-70228 TD-70221	8 PIN OCTAL 70169-D
INTERVAL ON	120V AC/DC 12V DC 24V AC/DC 240V AC	TD-70522 TD-70526 TD-70528 TD-70521	 DIAGRAM 1
FLASHER (OFF 1st)	120V AC/DC 12V DC 24V AC/DC 240V AC	TD-70822 TD-70826 TD-70828 TD-70821	
OFF DELAY	120V AC/DC 12V DC 24V AC/DC 240V AC	TD-71622 TD-71626 TD-71628 TD-71621	
SINGLE SHOT	120V AC/DC 12V DC 24V AC/DC 240V AC	TD-71522 TD-71526 TD-71528 TD-71521	11 PIN OCTAL 70170-D

■ See "Definitions of Timing Functions".

Sockets & Accessories available



- ◆ Pushbutton Thumbwheels for digital set of time delay
- ◆ 50ms - 999 hour programmable time range
- ◆ Uses industry-standard 8 or 11 pin octal sockets
- ◆ 10A DPDT output contacts
- ◆ LED indicates timing mode and time out conditions
- ◆ Pilot duty rating



with appropriate socket



Better. By Design.

800.238.7474

WWW.MACROMATIC.COM

SALES@MACROMATIC.COM

Build your Time Delay Relays with the [Online Product Builder](#)

TD-7 SERIES TIME RANGER™

APPLICATION DATA

Voltage Tolerance:

AC Operation: +10/-15% of nominal at 50/60 Hz.
DC Operation: +10/-15% of nominal.

Load (Burden):

3 VA

Setting Accuracy:

Constant Voltage & Temperature w/i specifications:

±0.1% of set time or ±50ms, whichever is greater

For Variable Voltage & Temperature w/i specifications:

±1% of set time or ±50ms, whichever is greater

Repeat Accuracy:

Constant Voltage & Temperature w/i specifications:

±0.1% of set time or ±0.02 seconds, whichever is greater

For Variable Voltage & Temperature w/i specifications:

±1% of set time or ±0.02 seconds, whichever is greater

Reset Time:

On Delay/Interval/Flasher: 0.1 Seconds
Functions with Control Switches: 0.04 Seconds

Start-up Time:

(Time from when power is applied until unit is timing)
0.05 Seconds for all units

Maintain Function Time:

(Time unit continues to operate after power is removed)
0.01 Seconds for all units

Temperature: Operating: -28° to 65°C (-18° to 149°F)
Storage: -40° to 85°C (-40° to 185°F)

Insulation Voltage: 2,000 volts

Output Contacts:

DPDT 10A @ 240V AC/30V DC,
1/2HP @ 120/240V AC (N.O.), 1/3HP @ 120/240V AC (N.C.)
B300 & R300; AC15 & DC13

Life:

Mechanical: 10,000,000 operations
Full Load: 100,000 operations

Compatibility:

Using a solid state switch to initiate the time sequence is acceptable. See www.macromatic.com/leakage or contact Macromatic for information regarding leakage current limits and other solid state design considerations.

Initiating Units with Control Switch Triggers:

Timing sequence must be initiated only after input voltage is applied to unit. Minimum required trigger switch closure time is 0.1 seconds.

LED:

Red LED. Refer to instruction sheet provided with product to determine code for relay & timing status.

Approvals:



File #E109466



File #LR45565



Low Voltage &
EMC Directives
EN60947-1, EN60947-5-1

DIMENSIONS

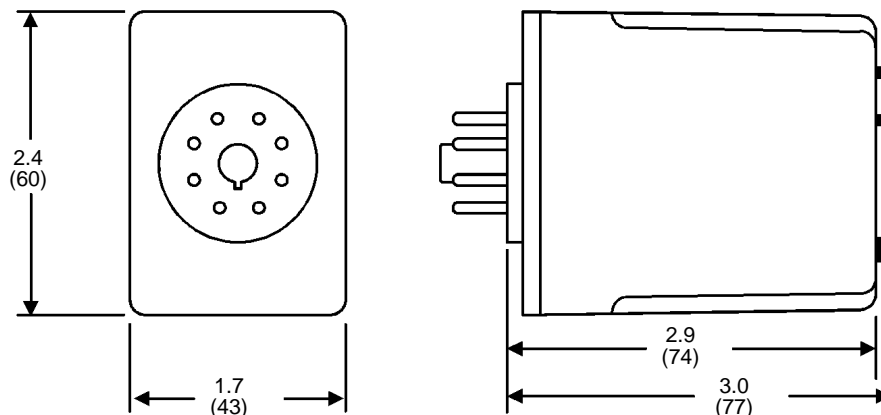

All Dimensions in
Inches (Millimeters)

PROGRAMMABLE | MULTI-FUNCTION

DIP-SWITCH | DIGITAL-SET | TD-8 SERIES

The TD-881 Series offers the digital-set accuracy of DIP-switch setting as well as the flexible programmability of a multi-function and multi-time range relay. These products provide an easy and accurate method to select any of 16 time delay functions and any time delay between 50ms and 10,230 hours (310 hours maximum for Dual Mode functions). Programming is accomplished through the use of two 10-position DIP-switches. This product can literally replace hundreds of different catalog numbers, thereby reducing inventory requirements.

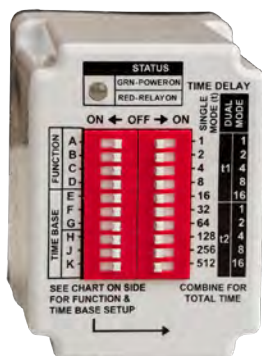

MULTI-FUNCTION ■ (16 Functions in One Unit)

Single Mode

- ◆ On Delay
- ◆ Interval On
- ◆ Flasher (OFF 1st)
- ◆ Flasher (ON 1st)
- ◆ Off Delay *
- ◆ Single Shot *
- ◆ Watchdog *
- ◆ Single Shot (Trailing Edge) *
- ◆ Triggered On Delay *

Dual Mode

- ◆ Repeat Cycle (OFF 1st)
- ◆ Repeat Cycle (ON 1st)
- ◆ Delayed Interval
- ◆ Triggered Delayed Interval *
- ◆ On/Off Delay *
- ◆ Single Shot-Flasher *
- ◆ On Delay/Flasher

* These are the only functions requiring use of the Control Switch shown in Wiring Diagrams below.

OUTPUT	INPUT VOLTAGE	CATALOG NUMBER	WIRING/ SOCKETS
11 Pin DPDT	120V AC/DC 12V DC 24V AC/DC 240V AC	TD-88122 TD-88126 TD-88128 TD-88121	11 PIN OCTAL 70170-D DIAGRAM 121
8 Pin SPDT	120V AC/DC 12V DC 24V AC/DC 240V AC	TD-88162 TD-88166 TD-88168 TD-88161	8 PIN OCTAL 70169-D DIAGRAM 169

■ See "Definitions of Timing Functions".

Sockets & Accessories available



- ◆ Sixteen user-selectable modes in one unit
- ◆ DIP-Switches for accurate digital set of time delay & selection of function
- ◆ 50ms - 10,230 hours programmable time delay (Single Mode functions only)
- ◆ Uses industry-standard 8 or 11 pin octal socket
- ◆ Pilot duty rating



with appropriate socket



Better. By Design.

800.238.7474

WWW.MACROMATIC.COM

SALES@MACROMATIC.COM

TIME DELAY RELAYS | PLUG-IN

Build your Time Delay Relays with the [Online Product Builder](#)

PROGRAMMABLE | SINGLE FUNCTION

DIP-SWITCH | DIGITAL-SET | TD-8 SERIES



Single Mode

Dual Mode

- ◆ DIP-Switches for accurate digital set of time delay
- ◆ 100ms - 1,023 hours programmable time delay
- ◆ Uses industry-standard 8 or 11 pin octal sockets
- ◆ 10A DPDT output contacts
- ◆ LED indicates relay status
- ◆ Pilot duty rating



with appropriate socket

The TD-8 Series time delay relays offer an easy and accurate method to select any time delay between 100ms and 1,023 hours. Programming is accomplished through the use of a 10-position DIP-switch. Each position is marked with a binary time increment. The required delay is selected by moving the switch of each increment to the ON position and adding their corresponding values (see examples below). This method provides a greater setting accuracy than is found on other units with an analog potentiometer. An LED indicates relay status.

FUNCTION ■	INPUT VOLTAGE 50/60Hz.	CATALOG NUMBER **	WIRING/SOCKETS
ON DELAY A	120V AC/DC 12V DC 24V AC/DC 240V AC	TD-80222-** TD-80226-** TD-80228-** TD-80221-**	8 PIN OCTAL 70169-D
INTERVAL ON B	120V AC/DC 12V DC 24V AC/DC 240V AC	TD-80522-** TD-80526-** TD-80528-** TD-80521-**	
REPEAT CYCLE * (OFF Time First Followed By ON Time and Repeating) L	120V AC/DC 12V DC 24V AC/DC 240V AC	TD-83122-** TD-83126-** TD-83128-** TD-83121-**	8 PIN OCTAL DIAGRAM 1
REPEAT CYCLE * (ON Time First Followed By OFF Time and Repeating) M	120V AC/DC 12V DC 24V AC/DC 240V AC	TD-85122-** TD-85126-** TD-85128-** TD-85121-**	
OFF DELAY Control Switch Trigger C	120V AC/DC 12V DC 24V AC/DC 240V AC	TD-81622-** TD-81626-** TD-81628-** TD-81621-**	11 PIN OCTAL 70170-D
SINGLE SHOT Control Switch Trigger D	120V AC/DC 12V DC 24V AC/DC 240V AC	TD-81522-** TD-81526-** TD-81528-** TD-81521-**	DIAGRAM 2

■ See "Definitions of Timing Functions".

* ON & OFF Time Ranges for these functions are the same. See www.macromatic.com/onoff for information on how to order a unit with different ON & OFF time ranges.

TIME DELAYS

**TIMING RANGE TABLE
COMPLETE PRODUCT NUMBER
USING TWO DIGIT CODE BELOW:
i.e., TD-80222-40

Time Delay Range	Code
0.1 - 102.3 Sec.	40
1 - 1,023 Sec.	41
10 - 10,230 Sec.	42
1 - 1,023 Min.	43
10 - 10,230 Min.	44
1 - 1,023 Hr.	45

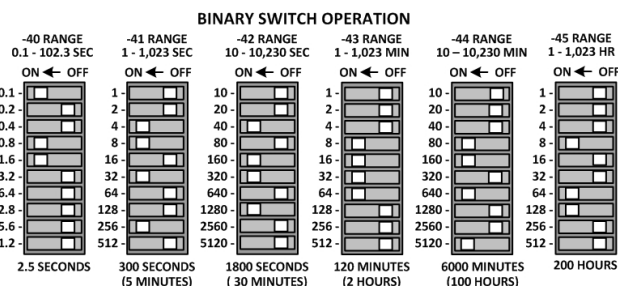

Better. By Design.

800.238.7474

WWW.MACROMATIC.COM

SALES@MACROMATIC.COM

Sockets & Accessories available

Build your Time Delay Relays with the [Online Product Builder](#)

TD-8 SERIES

DIP-SWITCH | DIGITAL-SET

PROGRAMMING FUNCTION & TIME DELAY

(TD-881 Series Multi-Function Only)

Programming is accomplished through the use of two 10-position DIP-switches. Switches A-D of the left-mounted DIP-switch are used to select a function (see the descriptions of how each function operates in "Definition of Timing Functions" in this catalog). Switches E, F & G of the same DIP-switch are used to select the time base (t) for single mode functions and (t1) for dual mode functions. Switches H, J & K are used to select the time base (t2) for dual mode functions. A convenient chart is on the side of the product to clearly illustrate how to set both the function and time base.

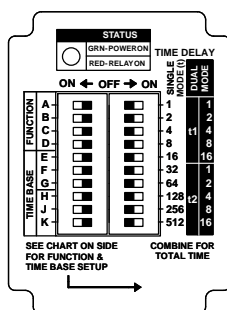

Top Side

SELECT FUNCTION				SELECT TIME BASE			
FUNCTION	A	B	C	D	BASE E	F	G
ON DELAY	OFF	OFF	OFF	OFF	0.1S	ON	OFF
INTERVAL ON	ON	OFF	OFF	OFF	1S	OFF	ON
OFF DELAY	OFF	ON	OFF	OFF	0.1M	OFF	ON
INT. ON DELAY	ON	ON	OFF	OFF	1M	ON	ON
FLASHER (ON)	OFF	OFF	ON	OFF	0.1H	ON	OFF
FLASHER (OFF)	ON	OFF	ON	OFF	1H	OFF	ON
WATCHDOG	OFF	ON	ON	OFF			
ONE SHOT T. EDGE	ON	ON	ON	OFF	BASE H J K		
SINGLE SHOT	OFF	OFF	OFF	ON	0.1S	ON	OFF
CYCLE (ON)	ON	OFF	OFF	ON	1S	OFF	ON
CYCLE (OFF)	OFF	ON	OFF	ON	0.1M	OFF	ON
DELAYED INTERVAL	ON	ON	OFF	ON	1M	ON	ON
ON/OFF DELAY	OFF	OFF	ON	ON	0.1H	ON	OFF
TR. DELAYED INT.	ON	OFF	ON	ON	1H	OFF	ON
ONE SHOT FLASHER	OFF	ON	ON	ON			
ON DELAY FLASHER	ON	ON	ON	ON			

NOTE: SWITCHES H, J & K ARE ONLY USED ON DUAL RANGE PRODUCTS

The right-mounted 10-position DIP-switch is used to select the time delay within the time base or bases selected with switches E-K from the first DIP-switch. Each position on the right-mounted DIP-switch is marked with a time increment. The required delay, (t) for single mode functions or (t1) and (t2) for dual mode functions, is selected by moving the switch of each increment to the ON position and adding their corresponding values. NOTE: Dual mode functions can either have the same or different (t1) and (t2) times as well as different time bases. NOTE: Switches H, J, & K are only used on dual mode functions and are not used for single mode functions.

LED Indicator: **Green ON--Power, Red ON--Relay Energized**

For more information, see www.macromatic.com/onoff.

APPLICATION DATA

Voltage Tolerance:

AC Operation: +10/-15% of nominal at 50/60 Hz.
DC Operation: +10/-15% of nominal.

Load (Burden): 2 VA

Setting Accuracy:

Constant Voltage & Temperature w/i specifications:
±0.1% of set time or ±50ms, whichever is greater
For Variable Voltage & Temperature w/i specifications:
±1% of set time or ±50ms, whichever is greater

Repeat Accuracy:

Constant Voltage & Temperature w/i specifications:
±0.1% of set time or ±0.02 seconds, whichever is greater
For Variable Voltage & Temperature w/i specifications:
±1% of set time or ±0.02 seconds, whichever is greater

Reset Time:

All Functions Triggered by a Control Switch: 0.04 Seconds
All Other Functions: 0.1 Seconds

Start-up Time:

(Time from when power is applied until unit is timing)
0.05 Seconds for all units

Maintain Function Time:

(Time unit continues to operate after power is removed)
0.01 Seconds for all units

Insulation Voltage: 2,000 volts

Temperature: Operating: -28° to 65°C (-18° to 149°F)
Storage: -40° to 85°C (-40° to 185°F)

Output Contacts:

DPDT 10A @ 240V AC/30V DC,
1/2HP @ 120/240V AC (N.O.), 1/3HP @ 120V AC (N.C.)
B300 & R300; AC15 & DC13

Life:

Mechanical: 10,000,000 operations
Full Load: 100,000 operations

Compatibility:

Using a solid state switch to initiate the time sequence is acceptable. See www.macromatic.com/leakage or contact Macromatic for information regarding leakage current limits and other solid state design considerations.

Control Switch Triggered Units:

Minimum required trigger switch closure time is 0.05 seconds.

Approvals:



File #E109466



File #LR45565



Low Voltage &
EMC Directives
EN60947-1, EN60947-5-1



UL LISTED
IND. CONT. EQUIP.
SUIT
with
appropriate
socket
File #E109466

DIMENSIONS

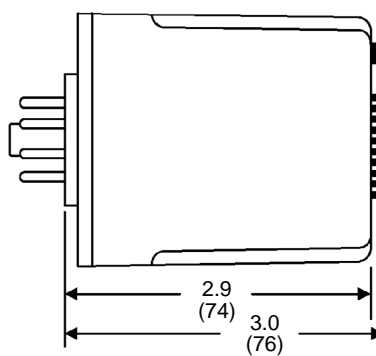
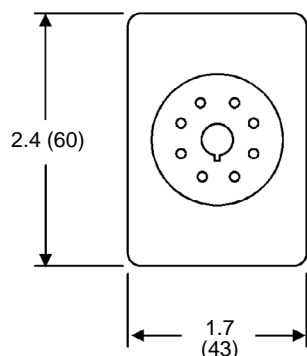

All Dimensions in Inches (Millimeters)

MULTI-FUNCTION | MULTI-RANGE

DIGITAL-SET | TAD SERIES



- ◆ Push-button thumbwheels for digital-setting of time delay & selection of function
- ◆ 10 field-selectable functions in one unit
- ◆ 10ms to 9,990 Hours programmable timing range
- ◆ Universal 24-240V AC/DC input voltage
- ◆ LCD display
- ◆ Panel, track or surface mounting
- ◆ 1/16 DIN style case (comes with panel-mounting adapter)
- ◆ 5A SPDT output contacts



TIME DELAY RELAYS | 1/16 DIN MOUNTING

MULTI-FUNCTION	INPUT VOLTAGE	CATALOG NUMBER	WIRING/SOCKETS ■
10 FIELD-SELECTABLE FUNCTIONS●	24-240V AC 50/60Hz & 24-240V DC 8 Pin Octal	TAD1U	SEE DIAGRAMS NEXT PAGE

- Functions Include: On Delay (2 Versions), Interval, Flicker [Flasher] (2 Versions), One Shot Out Flicker [Delayed Interval/Pulse], Off Delay, On/Off Delay, Interval Delay [Single Shot] & Integration Time [Accumulative On Delay] See "Definitions of Timing Functions".
- See below for **Sockets & Accessories**.

APPLICATION DATA

Voltage Tolerance:

±10% of rated voltage

Load (Burden):

Less than 2.5 VA

Repeat Accuracy:

±0.01%, ±0.05 seconds (includes variation due to voltage and temperature changes)

Recycle Time:

0.2 seconds maximum

Temperature:

Operating: -10° to 55°C (14° to 131°F)
Storage: -40° to 85°C (-40° to 185°F)

LCD Display: Shows time remaining in both digit & bar graph form--also shows relay status & time base. In addition, a switch on the bottom of the unit allows choice of timing up or timing down display.

Output Contacts:

5A SPDT Resistive @ 250V AC

Life:

Mechanical: 10,000,000 operations
Full Load: 100,000 operations

Approvals:



SOCKETS & ACCESSORIES

DESCRIPTION	PRODUCT NUMBER
8 Pin Octal Socket	70169-D❖
8 Pin Octal Socket (Back Mounting)	SR6P-M08G
Panel-Mounting Adaptor	Included

❖ For Surface or Track Mounting-See Sockets & Accessories for additional information



SR6P-M08G

DIMENSIONS

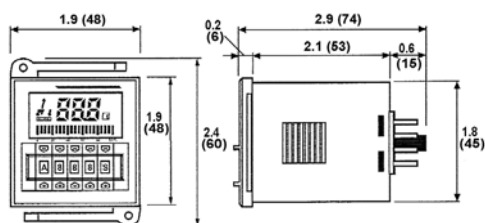

All Dimensions in Inches (mm)

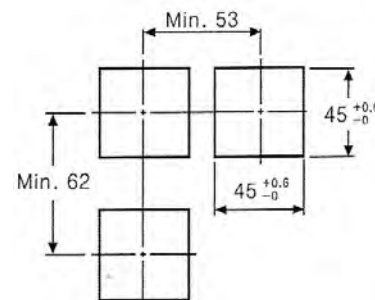

PANEL CUTOUT



Better. By Design.

800.238.7474

WWW.MACROMATIC.COM

SALES@MACROMATIC.COM

800.238.7474 | WWW.MACROMATIC.COM | SALES@MACROMATIC.COM

DEFINITION OF TIMING FUNCTIONS

DIGITAL-SET | TAD SERIES

Functions for TAD1U

<p>Mode</p> <p>A</p> <p>ON Delay</p> <p>1. Time progresses when START signal is ON. 2. The output will be ON when the setting value is equal to the display value. (Position ①) 3. When the RESET signal is ON, the display value is returned to the initial state. (Position ②) 4. When the setting value is equal to the display value, if START signal is OFF, the output turns off, the display value is held. (Position ③) * If START signal is OFF when the output is OFF the display value is returned to initial state. (Position ③)</p>	<p>Mode</p> <p>F</p> <p>One-shot Out Flicker</p> <p>1. Time progresses from initial value to the preset value repeatedly and the output operates as one-shot (0.3 sec.) when the START signal is ON. (Position ①) 2. If the RESET signal is ON, it is returned to initial state. (Position ②) * When START signal is applied repeatedly, only the initial signal is recognized. (Position ①)</p>
<p>Mode</p> <p>B</p> <p>Interval Delay</p> <p>1. The output turns ON and time progresses when START signal is ON. 2. The output will be ON when the setting value is equal to the display value. (Position ①) 3. When the RESET signal is ON, the display value is returned to the initial state. (Position ②) * If START signal is OFF when the output is OFF the display value is returned to initial state. (Position ③)</p>	<p>Mode</p> <p>H</p> <p>OFF Delay</p> <p>1. The START signal & the output are ON at the same time. The output will return and the display value is held after the setting time. 2. If the RESET signal is ON, the display value is returned to initial state. * If the START signal is applied continuously, the output will be ON but time is not progressed.</p>
<p>Mode</p> <p>C</p> <p>ON Delay</p> <p>1. Time proceeds when START signal is ON. 2. The output will be ON when the setting value is equal to the display value. (Position ①) 3. When the RESET signal is ON, the display value is returned to the initial state. * When start signal is applied repeatedly (Position ①), only the initial signal is recognized. * Even if the START signal is not applied, time progresses. (Position ②)</p>	<p>Mode</p> <p>K</p> <p>ON/OFF Delay</p> <p>1. When the START signal is ON the output is ON the output will be reset and display value is held when setting value is equal to display value. 2. The START signal turns OFF, the output turns ON, the output will be reset and display value is held when setting value is equal to display value. 3. If RESET signal is ON, it is returned to initial state. * If START signal is applied repeatedly, output keeps ON but be sure that the time will be initialized.</p>
<p>Mode</p> <p>D</p> <p>Flicker</p> <p>1. Time progresses repeatedly when the START signal is ON. 2. The output operates from NC to NO, and from NO to NC repeatedly. 3. If RESET signal is ON, it is returned to initial state. (Position ①) * If the START signal is OFF, the display value and output is returned to initial state. (Position ③)</p>	<p>Mode</p> <p>L</p> <p>Interval Delay</p> <p>1. When START signal is ON, the output turns ON and the time progresses at the same time. 2. When the time reaches at the preset value the output will be reset, and the display value is held. 3. If RESET signal is applied, the display value is returned to initial state. * When START signal is applied repeatedly, only the initial signal is recognized. (Position ①)</p>
<p>Mode</p> <p>E</p> <p>Flicker</p> <p>1. Time progresses repeatedly when the START signal is ON. 2. The output operates from NC to NO, and from NO to NC repeatedly. 3. If RESET signal is ON, it is returned to initial state. (Position ①) * When START signal is applied repeatedly, only the initial signal is recognized. (Position ①) * Even if the START signal is not applied, time progresses. (Position ②)</p>	<p>Mode</p> <p>N</p> <p>Integration Time</p> <p>1. When START signal is ON, time progresses. 2. If START signal turns off before the display value reaches the setting value, the time (display value) will be held. 3. If RESET signal is ON, it is returned to initial state.</p>

NOTE: Timing is paused when the INHIBIT signal is ON during a timing cycle and resumes when it is OFF.

TAD1U All Functions

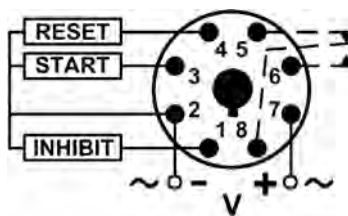

DIAGRAM 171

TIME DELAY RELAYS | DEFINITION OF TIMING FUNCTIONS

MULTI-FUNCTION | MULTI-RANGE

ANALOG-SET | TAA SERIES



- ◆ 6 field-selectable functions in one unit
- ◆ Large dial for setting of time delay
- ◆ 50ms to 100 Hours programmable timing range
- ◆ Universal 100-240V AC/ 24-240V DC input voltage
- ◆ Panel, track or surface mounting
- ◆ 1/16 DIN style case (comes with panel-mounting adaptor)



TIME DELAY RELAYS | 1/16 DIN MOUNTING



Better. By Design.

800.238.7474
WWW.MACROMATIC.COM
SALES@MACROMATIC.COM

MULTI-FUNCTION ◆	INPUT VOLTAGE	CATALOG NUMBER	WIRING/SOCKETS ■
Includes Six (6) Functions Built-in (See "Definitions of Timing Functions".)	100-240V AC 50/60Hz & 24-240V DC	TAA1U	SEE DIAGRAMS NEXT PAGE 8 Pin Octal
Includes Six (6) Functions Built-in (See "Definitions of Timing Functions".)	100-240V AC 50/60Hz & 24-240V DC	TAA2U	SEE DIAGRAMS NEXT PAGE 11 Pin Octal

- ◆ See "Definitions of Timing Functions".
- See below for Sockets & Accessories.

APPLICATION DATA

Voltage Tolerance:

±10% of rated voltage.

Load (Burden):

Less than 2.5 VA

Repeat Accuracy:

±0.01%, ±0.05 seconds (includes variation due to voltage and temperature changes).

Recycle Time:

0.2 seconds maximum.

Temperature:

Operating: -10° to 55°C (14° to 131°F)
 Storage: -40° to 85°C (-40° to 185°F)

LED Indicators:

One red LED indicates Input Voltage/ Timing (flashing) & a second red LED indicates relay status.

Output Contacts:

5A DPDT Resistive @ 250V AC

Enclosure Protection Rating:

IP40 (front face)

Life:

Mechanical: 10,000,000 operations
 Full Load: 100,000 operations

Approvals:



SOCKETS & ACCESSORIES

DESCRIPTION	PRODUCT NUMBER
8 Pin Octal Socket	70169-D❖
8 Pin Octal Socket (Back Mounting)	SR6P-M08G
11 Pin Octal Socket	70170-D❖
11 Pin Octal Socket (Back Mounting)	SR6P-M11G
Panel-Mounting Adaptor	Included

❖ For Surface or Track Mounting - See Sockets & Accessories for additional information



DIMENSIONS

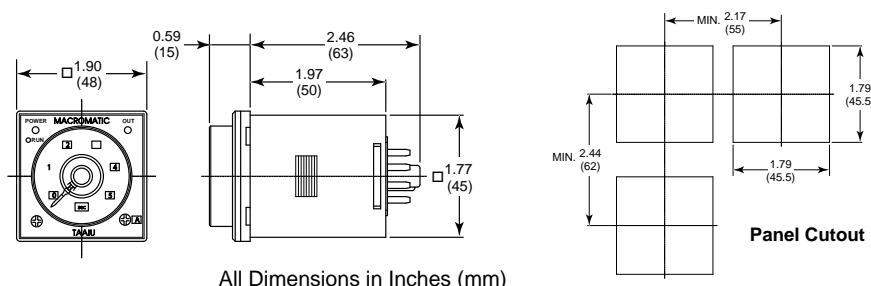

All Dimensions in Inches (mm)

DEFINITION OF TIMING FUNCTIONS

ANALOG-SET | TAA SERIES

Functions for TAA1U

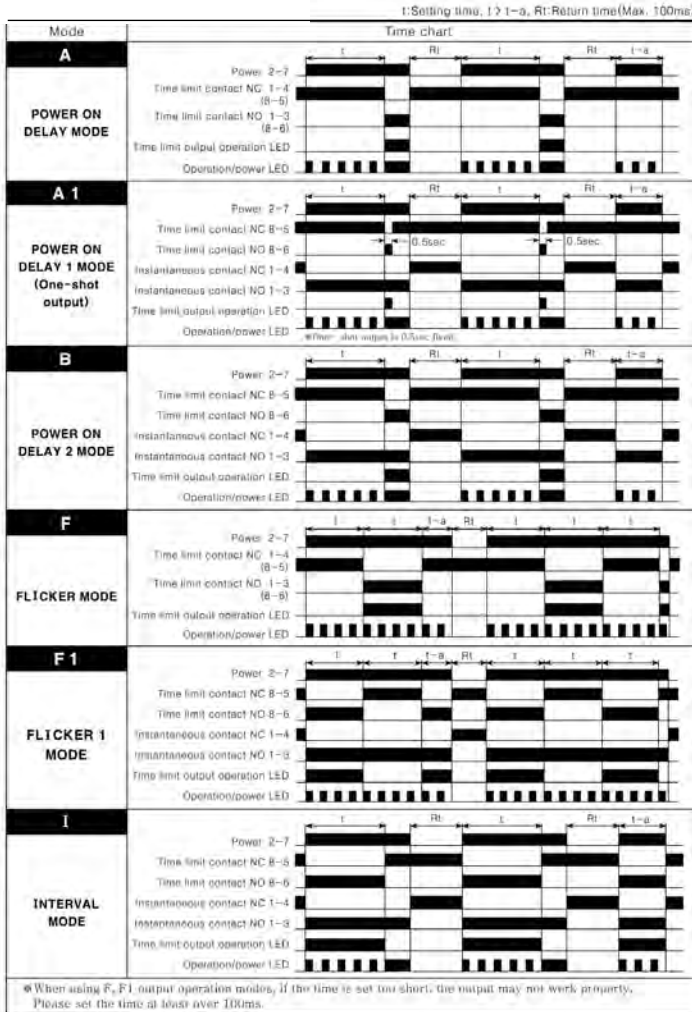

Functions for TAA2U

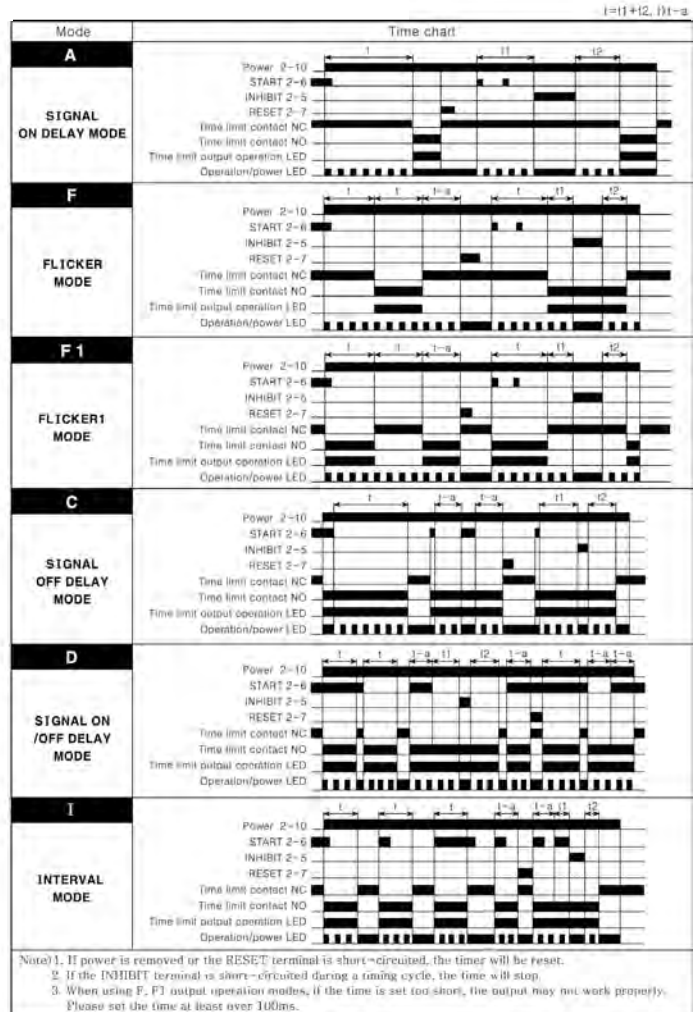

TAA1U Functions A, F

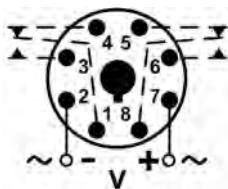

DIAGRAM 134

TAA1U Functions A1, B, F1 & I

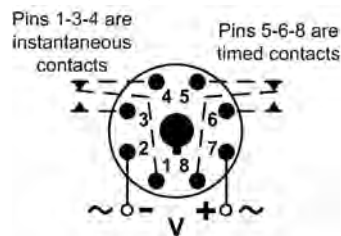

DIAGRAM 182

TAA2U All Functions

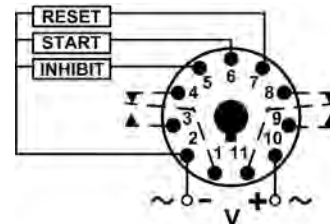

DIAGRAM 183

TIME DELAY RELAYS | DEFINITION OF TIMING FUNCTIONS

PROGRAMMABLE MULTI-FUNCTION | MULTI-RANGE

TE-881 SERIES



- ◆ 10 field-selectable functions in one unit
- ◆ Universal Input Voltage: 12-240V AC/DC
- ◆ 0.1 second - 10 days programmable time delay
- ◆ 15A SPDT output contacts
- ◆ LEDs indicate output relay status & timing mode
- ◆ Compact 17.5mm enclosure mounts on 35mm DIN track
- ◆ Pilot duty rating



Better. By Design.

800.238.7474

WWW.MACROMATIC.COM

SALES@MACROMATIC.COM

The TE-881 Series time delay relays offer 10 timing functions and a universal voltage input (12-240V AC/DC) with a programmable time range from 0.1 second – 10 days all in one compact unit. Choose between versions with 15A SPDT or DPDT output contacts. A green LED indicates input voltage applied; a red LED blinks during timing and is steady when the output relay is energized. These products have a compact 17.5mm enclosure which snaps on to 35mm DIN rail. This conserves space and reduces installation time, which saves money. With all this flexibility, the TE-881 Series replaces hundreds of separate time delay relays.

CATALOG NUMBER	TE-8816U	TE-8812U
Input		
Voltage Range	12-240V AC/DC, 50/60Hz	12-240V AC/DC, 50/60Hz
Tolerance	-15% of 12V, +10% of 240V	-15% of 12V, +10% of 240V
Burden	3VA (AC), 1.7W (DC)	3VA (AC), 1.7W (DC)
Output		
Configuration	SPDT	DPDT
Rating	15A @ 240V AC 1/3HP @ 120V AC, 3/4HP @ 240V AC, B300	
Minimum Switching	100mA	
Contact Material	Silver Alloy	
Life	10 million operations mechanical; 100,000 electrical	
Timing		
Number of Functions	10 (see descriptions on Page 44)	
Time Ranges	8 different time ranges built-in:	
	100 ms - 1 Sec.	0.1 - 1 Hr.
	1 - 10 Sec.	1 - 10 Hr.
	0.1 - 1 Min.	0.1 - 1 Day
	1 - 10 Min.	1 - 10 Days
Repeat Accuracy	±0.2%	
Setting Accuracy	5%	
Reset Time	150ms maximum	
Trigger Pulse Length	50ms maximum	
Other		
Mounting	35mm DIN Rail only	
Agency Approval	cULus CE (File #E109466)	
Temperature	Storage: -30° to 70° C (-22° to 158° F) Operating: -20° to 55° C (-4° to 131° F)	
LED Indication	Green-Input Voltage; Red-Timing or Relay ON	
Terminations	12-22 AWG, 3.5 in-lbs	

TIME DELAY RELAYS | 17.5MM

PROGRAMMABLE MULTI-FUNCTION | MULTI-RANGE

TE-881 SERIES

FUNCTIONS

FUNCTION	DIAL SETTING	GRAPH	FUNCTION	DIAL SETTING	GRAPH
ON DELAY	A		Flasher* (ON 1ST)	F	
Flasher* (OFF 1ST)	B		PULSE GENERATOR (PULSE=0.5 SEC)	G	
INTERVAL	C		ONE SHOT	H	
OFF DELAY	D		ON/OFF DELAY *	I	
RETRIGGERABLE ONE SHOT (Watchdog)	E		MEMORY LATCH (Latching Relay)	J	

* Note: ON & OFF times are the same.

CONNECTION DIAGRAMS

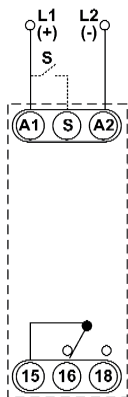

TE-8816U
SPDT

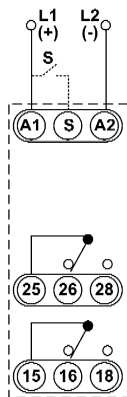

TE-8812U
DPDT

DIMENSIONS

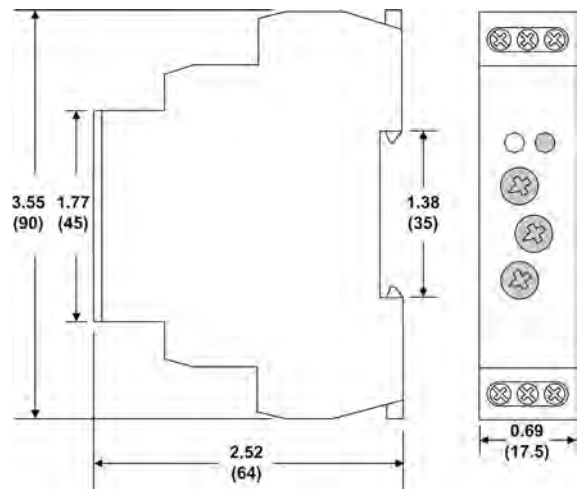

All Dimensions in
Inches (Millimeters)

TIME DELAY RELAYS | 17.5MM

SINGLE-FUNCTION | MULTI-RANGE

TE-6 SERIES



- ◆ Single function time delay
- ◆ Universal Input Voltage: 12-240V AC/DC
- ◆ 0.1 second - 100 hours time delay ranges
- ◆ 10A SPDT output contacts
- ◆ LEDs indicate output relay status & timing mode
- ◆ Compact 17.5mm enclosure mounts on 35mm DIN-rail



Single function TE-6 Series Series Time Delay Relays are used for applications where timing function does not change. All functions initiated by the control voltage can use the control input to inhibit the ongoing delay.

The relays offer ten timing ranges with a universal voltage input (12 -240V AC/DC).

A compact 17.5 mm enclosure mounts on 35 mm DIN-rail.

FUNCTION	OUTPUT CONFIGURATION	CONTROL VOLTAGE	CATALOG NUMBER
ON Delay	10A SPDT	12 - 240V AC/DC	TE-6026U
Star Delta	(2) Independent 10A SPDT	12 - 240V AC/DC	TE-6041U
OFF Delay (Switch Trigger)	10A SPDT	12 - 240V AC/DC	TE-6166U

TIME DELAY RELAYS | 17.5MM



Better. By Design.

800.238.7474

WWW.MACROMATIC.COM

SALES@MACROMATIC.COM

SINGLE-FUNCTION | MULTI-RANGE

TE-6 SERIES

APPLICATION DATA

Operating Range:

-15% of 12V, +10% of 240V (-15%, +10%)

Burden (max.):

2 VA / 1.5 W

Control Voltage Tolerance:

-15%; $\pm 10\%$

Contact Rating:

10A @ 250V AC

Minimum Switching:

100mA @ 5V

Contact Material:

Silver Alloy

Life:

Models TE-6026U & TE-6166U:

10 million operations mechanical; 50,000 electrical

Model TE-6041U:

10 million operations mechanical; 100,000 electrical

Time Ranges:

Ten Ranges: 0.1 Sec. - 100 Hr.

Time Setting:

Rotary Switch and Potentiometer

Repeat Accuracy:

$\pm 0.2\%$

Setting Accuracy:

5%

Reset Time:

150ms maximum

Trigger Pulse Length:

50ms minimum

Temperature:

Storage: -30° to 70° C (-22° to 158° F)

Operating: -20° to 55° C (-4° to 131° F)

Dielectrical Strength:

4 kV AC

Protection Degree:

IP40 from front panel / IP20 terminals

Pollution Degree:

2

LED Indications:

Models TE-6026U & TE-6166U:

Green - Control Voltage; Red - Timing or Relay ON

Model TE-6041U:

Multifunction Red LED

Terminations:

Models TE-6026U & TE-6166U:

Solid or stranded wire, 12-22 AWG

Model TE-6041U:

Solid or stranded wire, 1x 14 AWG, 2x 16 AWG

Weight:

Models TE-6026U & TE-6166U: 61 g (0.13 lb)

Model TE-6041U: 78 g (0.17 lb)

Approvals:

File #E236146

SINGLE-FUNCTION | MULTI-RANGE

TE-6 SERIES

FUNCTIONS

FUNCTION	DESCRIPTION	GRAPH
ON DELAY (TE-6026U)	Upon application of input voltage, the time delay (t) begins. At the end of the time delay (t), the output is energized. Input voltage must be removed to reset the time delay relay and de-energize the output.	
ON DELAY WITH INHIBIT (TE-6026U)	Upon application of input voltage, the time delay (t) begins. At the end of the time delay (t), the output is energized. Input voltage must be removed to reset the time delay relay and de-energize the output. If the control contact (S) is closed during the time delay, the timing is paused and continues only after the control contact(S) reopens.	
OFF DELAY (TE-6166U)	Upon application of input voltage, the time delay relay is ready to accept a trigger. When the trigger is applied, the output is energized. Upon removal of the trigger, the time delay (t) begins. At the end of the time delay (t), the output is de-energized. Any application of the trigger during the time delay will reset the time delay (t) and the output remains energized.	
STAR/DELTA (TE6041U)	Upon application of input voltage, the star time (t1) begins and the star output is energized. At the end of the star time delay (t1), the star output is de-energized and the transfer time delay (t2) begins. During transfer time delay (t2) the star and delta outputs are de-energized. At the end of the transfer time delay (t2), the delta output is energized. Input voltage must be removed to reset the time delay relay.	

TIME DELAY RELAYS | 17.5MM

WIRING

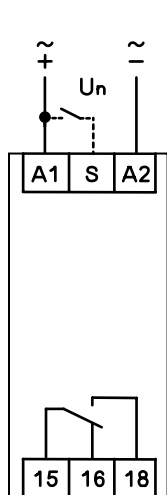

Models TE-6026U and TE-6166U

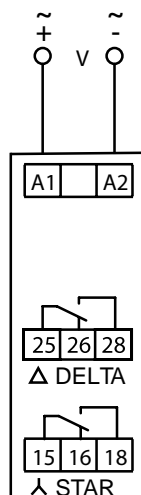

Model TE-6041U

DIMENSIONS

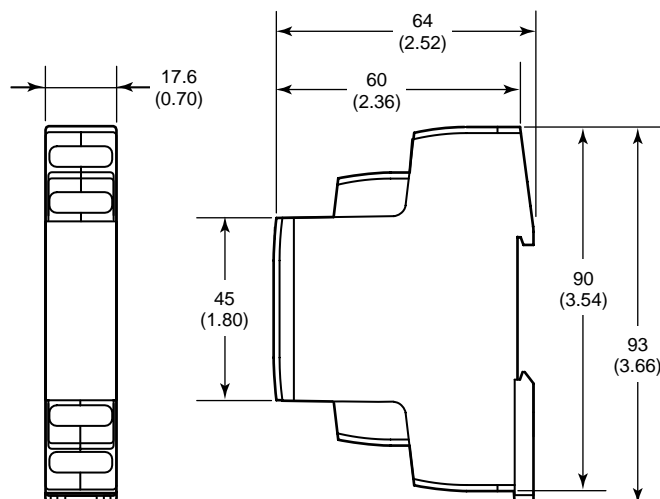

All Dimensions in Inches (Millimeters)

SINGLE-FUNCTION | SINGLE-RANGE

TE5 SERIES



- ◆ 15 Time Delay Functions available
- ◆ Universal Control Voltage: 24V-240V AC & 12-240V DC
- ◆ Adjustable or Factory Fixed Time ranges from 50ms to 100 hours
- ◆ Slim 17.5mm slim design for compact DIN-Rail mounting
- ◆ LEDs indicate power applied, output relay status and timing mode
- ◆ 10A SPDT or DPDT outputs available
- ◆ Proudly manufactured in the United States



Better. By Design.

800.238.7474

WWW.MACROMATIC.COM

SALES@MACROMATIC.COM

The TE5 Series of 17.5MM time delay relays provide precise time-based control in a compact package, saving valuable space. Each product has a single dedicated function and time range so there is no complicated setup required before use. Time delays from 0.05 seconds up to 100 hours can be accomplished across 17 user-adjustable time ranges, or factory fixed times (non-adjustable) are also available. Select from 15 unique timing functions to meet your specific control and automation needs.

FUNCTION	CONTROL VOLTAGE	CATALOG NUMBER	WIRING
On Delay	24-240V AC, 12-240V DC	TE5022U-** TE5026U-**	Diagram 910 Diagram 907
Interval On	24-240V AC, 12-240V DC	TE5052U-** TE5056U-**	Diagram 910 Diagram 907
Flasher (Off 1st)	24-240V AC, 12-240V DC	TE5082U-** TE5086U-**	Diagram 910 Diagram 907
Flasher (On 1st)	24-240V AC, 12-240V DC	TE5092U-** TE5096U-**	Diagram 910 Diagram 907
On Delay (Switch Trigger)	24-240V AC, 12-240V DC	TE5122U-** TE5126U-**	Diagram 909 Diagram 908
Watchdog (Switch Trigger)	24-240V AC, 12-240V DC	TE5132U-** TE5136U-**	Diagram 909 Diagram 908
Single Shot (Switch Trigger)	24-240V AC, 12-240V DC	TE5152U-** TE5156U-**	Diagram 909 Diagram 908
Off Delay (Switch Trigger)	24-240V AC, 12-240V DC	TE5162U-** TE5166U-**	Diagram 909 Diagram 908
Single Shot Falling Edge (Switch Trigger)	24-240V AC, 12-240V DC	TE5222U-** TE5226U-**	Diagram 908
Memory Latch (Switch Trigger)	24-240V AC, 12-240V DC	TE5292U-** TE5296U-**	Diagram 908
Repeat Cycle (OFF 1st)	24-240V AC, 12-240V DC	TE5312U-** TE5316U-**	Diagram 910 Diagram 907
On Delay/Off Delay (Switch Trigger)	24-240V AC, 12-240V DC	TE5412U-** TE5416U-**	Diagram 909 Diagram 908
Repeat Cycle (ON 1st)	24-240V AC, 12-240V DC	TE5512U-** TE5516U-**	Diagram 910 Diagram 907
Delayed Interval	24-240V AC, 12-240V DC	TE5612U-** TE5615U-**	Diagram 910 Diagram 907
Delayed Interval (Trigger)	24-240V AC, 12-240V DC	TE5652U-** TE5656U-**	Diagram 909 Diagram 908
Memory Latch (Switch Triggered)	24-240V AC, 12-240V DC	TE5292U-** TE5296U-**	Diagram 909 Diagram 908

Dial Setting	Timing Range
A	0.05 - 0.5 Sec.
B	0.1 - 1 Sec.
C	0.3 - 30 Sec.
D	0.6 - 60 Sec.
E	1 - 100 Sec.
F	1.2 - 120 Sec.
G	1.8 - 180 Sec.
H	3 - 300 Sec.
I	10 - 1,000 Sec.

Dial Setting	Timing Range
J	0.1 - 10 Sec.
K	0.3 - 30 Min.
L	0.6 - 60 Min.
M	1 - 100 Min.
N	10 - 1,000 Min.
O	1.2 - 120 Min.
P	0.1 - 10 Hrs.
Q	1 - 100 Hrs.
F	Fixed Time Range

SINGLE-FUNCTION | MULTI-RANGE

TE5 SERIES

APPLICATION DATA

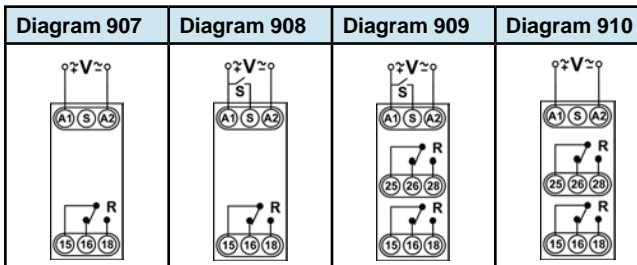

APPLICATION DATA

Voltage Tolerance:

Control Voltage:
24-240 V AC
12-240 V DC

AC Operation +10/-15% of nominal at 50/60 Hz
DC Operation -10/15% of nominal

Load (Burden): Maximum of 4 VA

Setting Accuracy:

Maximum Setting (Adjustable): +5% -0%
Minimum Setting (Adjustable) +0% - 50%
Fixed Time Delay: ±2% or 50ms, whichever is greater

Repeat Accuracy:

Constant voltage and temperature ±0.1% or ± 0.05 seconds, whichever is greater
Changing voltage and temperature within limits ±5% or ± 0.1 seconds, whichever is greater

Reset Time:

Triggered with input Voltage: 0.1 seconds
Triggered with Control Switch: 0.04 seconds

Start-up Time:

Time from when power is applied until unit is timing: 0.05 seconds

Maintain Function Time:

Time unit continues to operate after power is removed: 0.01 Seconds.
Interruptions longer than this time may reset the timing cycle.

Minimum required trigger switch closure: 0.05 seconds

Temperature:

Operating -28° to 65°C (-18° to 149° F)
Storage: -40° to 85° C (-49° to 185° F)

Output Contact Ratings: 10A @ 250VAC / 8A @ 30VDC SPDT/ DPDT

Life:

Mechanical: 10,000,000 operations; Full load: 100,000 operations

Mounting:

35mm DIN Rail required, panel mounting with screw not supported

Wiring:

Flat blade (slotted) screw terminals, Wire size: 12-22AWG Maximum tightening torque: 4in-lb. Recommend 1/8" (3 mm) screw drivers.

DIMENSIONS

SPDT

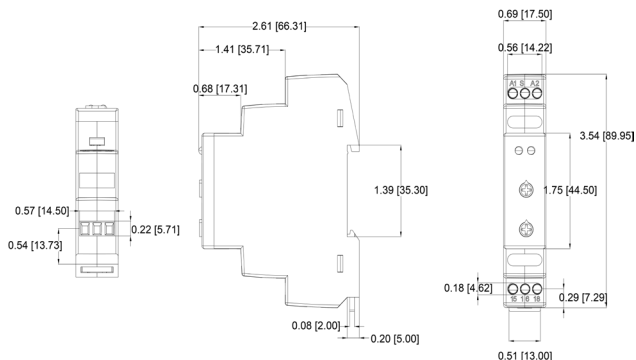

DPDT

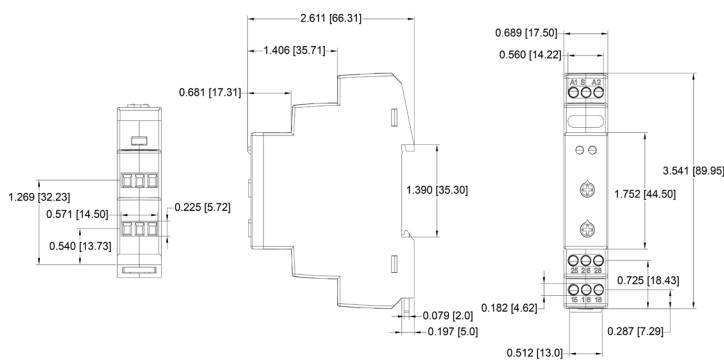

SOCKETS & ACCESSORIES

8 Pin Octal Socket- Surface or DIN Rail-Mounted

- ◆ 10A @ 600V
- ◆ 1 or 2 #12-20 AWG Wire
- ◆ Pressure Wire Clamp Terminations
- ◆ Recommended Tightening Torque 12 in-lbs



File #E169693 File #LR701114



Catalog Number:
70169-D

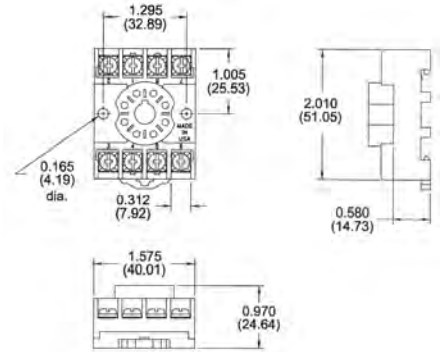
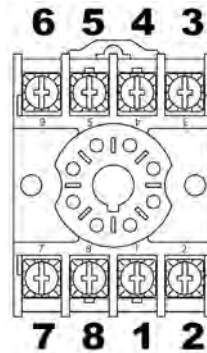

11 Pin Octal Socket Surface or DIN Rail-Mounted

- ◆ 10A @ 300V
- ◆ 1 or 2 #12-20 AWG Wire
- ◆ Pressure Wire Clamp Terminations
- ◆ Recommended Tightening Torque 12 in-lbs



File #E169693 File #LR701114



Catalog Number:
70170-D

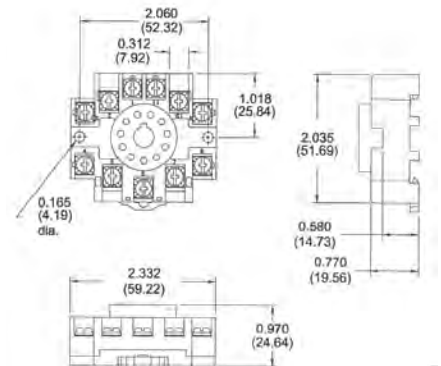
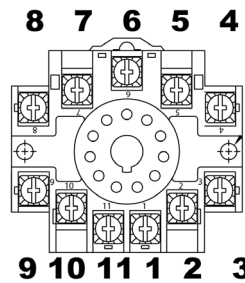

8 Pin Octal Socket Back-Mounted

- ◆ 10A @ 300V
- ◆ Pressure Wire Clamp Terminations
- ◆ Recommended Tightening Torque 7 in-lbs



File #E60008



Catalog Number:
SR6P-M08G

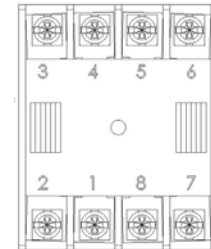

11 Pin Octal Socket Back-Mounted

- ◆ 10A @ 300V
- ◆ Pressure Wire Clamp Terminations
- ◆ Recommended Tightening Torque 7 in-lbs



File #E60008



Catalog Number:
SR6P-M11G

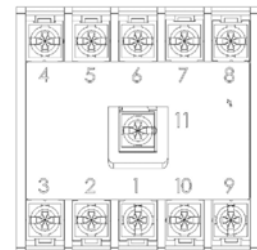

SOCKETS & ACCESSORIES

8 Pin Octal Socket- Surface or DIN Rail-Mounted

- ◆ 10A @ 600V
- ◆ 1 or 2 #12-20 AWG Wire
- ◆ Pressure Wire Clamp Terminations
- ◆ Recommended Tightening Torque 12 in-lbs



File #E169693 File #LR701114



Catalog Number:
70169-D

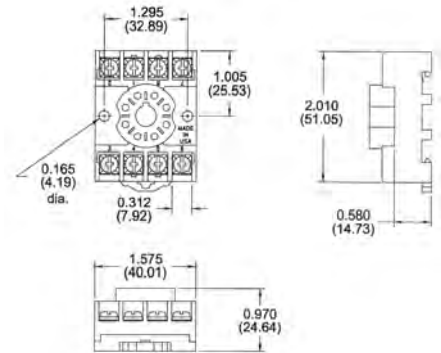
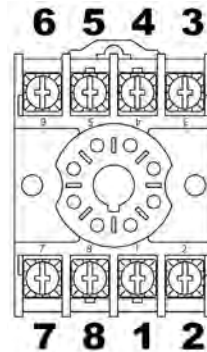

11 Pin Octal Socket Surface or DIN Rail-Mounted

- ◆ 10A @ 300V
- ◆ 1 or 2 #12-20 AWG Wire
- ◆ Pressure Wire Clamp Terminations
- ◆ Recommended Tightening Torque 12 in-lbs



File #E169693 File #LR701114



Catalog Number:
70170-D

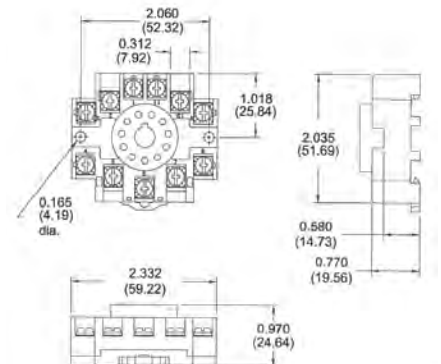
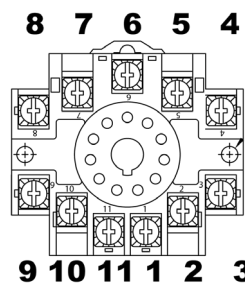

8 Pin Octal Socket Back-Mounted

- ◆ 10A @ 300V
- ◆ Pressure Wire Clamp Terminations
- ◆ Recommended Tightening Torque 7 in-lbs



File #E60008



Catalog Number:
SR6P-M08G

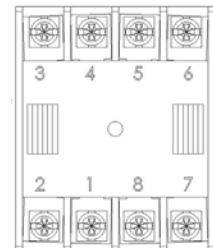

11 Pin Octal Socket Back-Mounted

- ◆ 10A @ 300V
- ◆ Pressure Wire Clamp Terminations
- ◆ Recommended Tightening Torque 7 in-lbs



File #E60008



Catalog Number:
SR6P-M11G

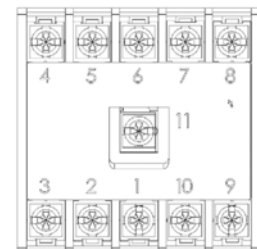

SOCKETS & ACCESSORIES

Hold Down Spring Catalog Number 70166

Can be used for:

- ◆ Panel-Mounted Sockets
- ◆ Sockets Mounted to 35mm DIN Rail *

* Requires two #8, 3/4" length machine screws with washers & nuts--contact Macromatic or www.macromatic.com/70166 for more information.



DIN Rail Adaptor Kit Catalog Number 70500

Quick & Economical Way to Install Any THx Series 2" x 2" Encapsulated Time Delay Relays on 35mm DIN Rail

- ◆ Clip Comes with a Threaded Hole to Eliminate Need for a Washer & Nut
- ◆ All Mounting Hardware Included
- ◆ Recommended Tightening Torque of 8 in-lbs.



DEFINITION OF TIMING FUNCTIONS

Understanding the differences between all the functions available in time delay relays can sometimes be a daunting task. To begin with, time delay relays are simply control relays with a time delay built in. Their purpose is to control an event based on time.

Typically, time delay relays are initiated or triggered by one of two methods, depending on the function:

- ◆ application of input voltage
- ◆ application of a trigger

These triggers can be one of two signals: a control switch (dry contact), i.e., limit switch, push button, float switch, etc., or voltage (commonly known as a power trigger).

CAUTION: any time delay relay that is designed to be initiated with a dry contact control switch trigger could be damaged if voltage is applied to the trigger switch terminals. Only products that have a “power trigger” should be used with voltage as the trigger.

To help understand, some definitions are important:









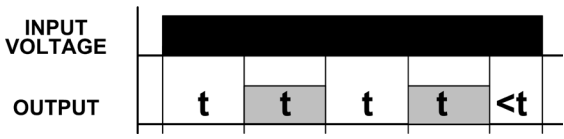

- ◆ Input Voltage - control voltage applied to the input terminals. Depending on the function, input voltage will either initiate the unit or make it ready to initiate when a trigger is applied.
- ◆ Trigger- on certain timing functions, a trigger is used to initiate the unit after input voltage has been applied. As noted above, this trigger can either be a control switch (dry contact switch) or a power trigger (voltage).
- ◆ Output (Load) - every time delay relay has an output (either mechanical relay or solid state) that will open & close to control the load. Note that the user must provide the voltage to power the load being switched by the output contacts of the time delay relay. In all wiring diagrams, the output is shown in the normal de-energized position.

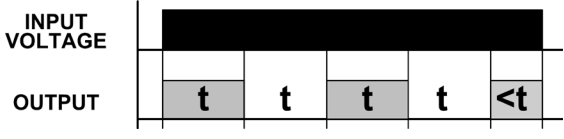
Below and on the following pages are both written and visual descriptions on how the common timing functions operate. A Timing Chart shows the relationship between Input Voltage, Trigger (if present) and Output. If you cannot find a product to fit your requirements or have any questions, Macromatic’s Application Engineers offer technical information along with product selection and application assistance. Call us at 800-238-7474 or e-mail us tech-help@macromatic.com.

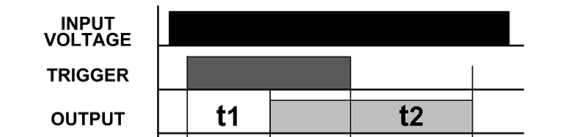
Function/Code	Operation	Timing Chart
ON DELAY Delay on Operate Delay on Make A	Upon application of input voltage, the time delay (t) begins. At the end of the time delay (t), the output is energized. Input voltage must be removed to reset the time delay relay & de-energize the output..	
INTERVAL ON Interval B	Upon application of input voltage, the output is energized and the time delay (t) begins. At the end of the time delay (t), the output is de-energized. Input voltage must be removed to reset the time delay relay.	
OFF DELAY Delay on Release Delay on Break Delay on De-Energization C	Upon application of input voltage, the time delay relay is ready to accept a trigger. When the trigger is applied, the output is energized. Upon removal of the trigger, the time delay (t) begins. At the end of the time delay (t), the output is de-energized. Any application of the trigger during the time delay will reset the time delay (t) and the output remains energized.	
SINGLE SHOT One Shot Momentary Interval D	Upon application of input voltage, the time delay relay is ready to accept a trigger. When the trigger is applied, the output is energized and the time delay (t) begins. During the time delay (t), the trigger is ignored. At the end of the time delay (t), the output is de-energized and the time delay relay is ready to accept another trigger.	

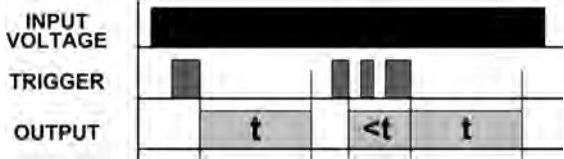
TIME DELAY RELAYS | DEFINITION OF TIMING FUNCTIONS

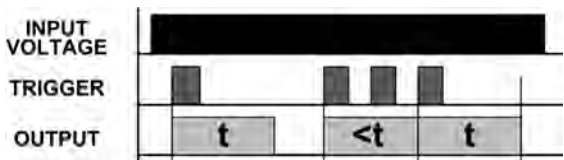
DEFINITION OF TIMING FUNCTIONS

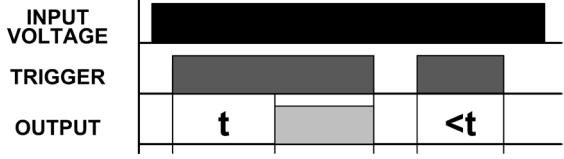
Function/Code	Operation	Timing Chart
FLASHER (Off First) 	<p>Upon application of input voltage, the time delay (t) begins. At the end of the time delay (t), the output is energized and remains in that condition for the time delay (t). At the end of the time delay (t), the output is de-energized and the sequence repeats until input voltage is removed.</p>	
FLASHER (ON First) 	<p>Upon application of input voltage, the output is energized and the time delay (t) begins. At the end of the time delay (t), the output is de-energized and remains in that condition for the time delay (t). At the end of the time delay (t), the output is energized and the sequence repeats until input voltage is removed.</p>	
ON/OFF DELAY 	<p>Upon application of input voltage, the time delay relay is ready to accept a trigger. When the trigger is applied, the time delay (t1) begins. At the end of the time delay (t1), the output is energized. When the trigger is removed, the output contacts remain energized for the time delay (t2). At the end of the time delay (t2), the output is de-energized & the time delay relay is ready to accept another trigger. If the trigger is removed during time delay period (t1), the output will remain de-energized and time delay (t1) will reset. If the trigger is reapplied during time delay period (t2), the output will remain energized and the time delay (t2) will reset.</p>	 <p>* For TD-7 catalog numbers, t1 & t2 are the same length of time.</p>
SINGLE SHOT FALLING EDGE 	<p>Upon application of input voltage, the time delay relay is ready to accept a trigger. When the trigger is applied, the output remains de-energized. Upon removal of the trigger, the output is energized and the time delay (t) begins. At the end of the time delay (t), the output is de-energized unless the trigger is removed and re-applied prior to time out (before time delay (t) elapses). Continuous cycling of the trigger at a rate faster than the time delay (t) will cause the output to remain energized indefinitely.</p>	
WATCHDOG Retriggerable Single Shot 	<p>Upon application of input voltage, the time delay relay is ready to accept a trigger. When the trigger is applied, the output is energized and the time delay (t) begins. At the end of the time delay (t), the output is de-energized unless the trigger is removed and re-applied prior to time out (before time delay (t) elapses). Continuous cycling of the trigger at a rate faster than the time delay (t) will cause the output to remain energized indefinitely.</p>	
TRIGGERED ON DELAY 	<p>Upon application of input voltage, the time delay relay is ready to accept a trigger. When the trigger is applied, the time delay (t) begins. At the end of the time delay (t), the output is energized and remains in that condition as long as either the trigger is applied or the input voltage remains. If the trigger is removed during the time delay (t), the output remains de-energized & the time delay (t) is reset.</p>	

DEFINITION OF TIMING FUNCTIONS

TIME DELAY RELAYS | DEFINITION OF TIMING FUNCTIONS

Function/Code	Operation	Timing Chart
REPEAT CYCLE (OFF 1st) 	Upon application of input voltage, the time delay (t1) begins. At the end of the time delay (t1), the output is energized and remains in that condition for the time delay (t2). At the end of this time delay, the output is de-energized and the sequence repeats until input voltage is removed.	
REPEAT CYCLE (ON 1st) 	Upon application of input voltage, the output is energized and the time delay (t1) begins. At the end of the time delay (t1), the output is de-energized and remains in that condition for the time delay (t2). At the end of this time delay, the output is energized and the sequence repeats until input voltage is removed.	
DELAYED INTERVAL Single Cycle 	Upon application of input voltage, the time delay (t1) begins. At the end of the time delay (t1), the output is energized and remains in that condition for the time delay (t2). At the end of this time delay (t2), the output is de-energized. Input voltage must be removed to reset the time delay relay.	
TRIGGERED DELAYED INTERVAL 	Upon application of input voltage, the time delay relay is ready to accept a trigger. When the trigger is applied, the time delay (t1) begins. At the end of the time delay (t1), the output is energized and remains in that condition for the time delay (t2). At the end of the time delay (t2), the output is de-energized & the relay is ready to accept another trigger. During both time delay (t1) & time delay (t2), the trigger is ignored.	
TRUE OFF DELAY 	Upon application of input voltage, the output is energized. When the input voltage is removed, the time delay (t) begins. At the end of the time delay (t), the output is de-energized. Input voltage must be applied for a minimum of 0.1 seconds to assure proper operation. Any application of the input voltage during the time delay (t) will reset the time delay. No external trigger is required.	
ON DELAY/ TRUE OFF DELAY 	Upon application of input voltage, the time delay (t1) begins. At the end of the time delay (t1), the output is energized. When the input voltage is removed, the output remains energized for the time delay (t2). At the end of the time delay (t2), the output is de-energized. Input voltage must be applied for a minimum of 0.1 seconds to assure proper operation. Any application of the input voltage during the time delay (t2) will keep the output energized & reset the time delay (t2). No external trigger is required.	
SINGLE SHOT-FLASHER 	Upon application of input voltage, the time delay relay is ready to accept a trigger. When the trigger is applied, the time delay (t1) begins and the output is energized for the time delay (t2). At the end of this time delay (t2), the output is de-energized and remains in that condition for the time delay (t2). At the end of the time delay (t2), the output is energized and the sequence repeats until time delay (t1) is completed. During the time delay (t1), the trigger is ignored.	
ON DELAY-FLASHER 	Upon application of input voltage, the time delay begins (t1). At the end of the time delay (t1), the output is energized and remains in that condition for the time delay (t2). At the end of this time delay (t2), the output is de-energized and remains in that condition for the time delay (t2). At the end of the time delay (t2), the output is energized and the sequence repeats until input voltage is removed.	
MEMORY LATCHING	Upon application of control voltage, the relay is ready to accept a trigger. When the first trigger is applied, the output is energized. Removing and re-applying will cause the output to deenergize. Removing and reapplying the trigger will cause the output to change state. Removing control power deactivates the relay regardless of the trigger.	

Your source for quality, innovative industrial control solutions

Macromatic Industrial Controls, Inc. designs and manufactures control, monitoring and protection products to manage your electrical processes and to protect your equipment from damaging fault conditions.

With a 45-year legacy of high-quality products and outstanding customer service, we continue to introduce innovative solutions that help our customers be more productive and efficient.

Our design and application experience makes it easy to find cost-effective advantages for your applications.

We continuously improve our products by integrating new technology and improving our manufacturing processes. The result is innovative reliable products, delivered on-time, every time.

www.macromatic.com

800.238.7474



Better. By Design.

Macromatic Industrial Controls Family of Products

MACROMATIC INDUSTRIAL CONTROLS



Better. By Design.
800.238.7474 | WWW.MACROMATIC.COM | SALES@MACROMATIC.COM

LCTTR00AEN1222