



FRT connect

Bring your pushbuttons and switches to the M12 world

4-5-6

simple
fast
universal



➔ **Bring your pushbuttons and switches to the M12 world - ingeniously simple!**



→ **Time-consuming and costly wiring is no longer necessary**

The FRT connect with M12 connector means no conventional or error-prone wiring. The installation with M12 connector is simple and safe, a reverse or incorrect polarity is not possible. Plug&work: plug in and get started!



→ **For combination with various series**

The FRT connect contact blocks are suitable for SCHLEGEL pushbuttons and switches for mounting diameter 22.3 or 16.2 mm with 16 mm housing neck and 3 mm travel. The diversity of possible contact equipments ranges from only 1 NO to 2 NC with illumination.



→ **4- and 5-pole M12 connectors**

There is also the flexibility in choosing the type of connection: With FRT connect you have the choice between a 4-pole connector with SCHLEGEL pin assignment or a 5-pole connector with AIDA pin assignment. The connectors are A coded.



→ **Illuminated variants**

FRT connect can also be used for pushbuttons and switches with illumination. If you connect the illuminated variants of FRT connect with an emergency-stop head or a pilot light head - FRT connect is accentuating it.



→ **High switching capacity and long lifetime**

SCHLEGEL attaches great importance to the quality and robustness of its products. This also applies to the new FRT connect. The contact blocks are characterised by a long lifetime and a high switching capacity.





Contact blocks FRT connect



MADE IN GERMANY







M12 plugs

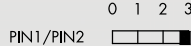
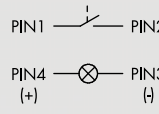
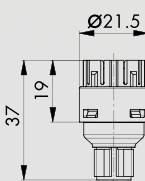

Illustration	Description	Type
 <p>IP00 3 mm LED</p>	 <p>0 1 2 3 PIN1/PIN4 PIN5/PIN2</p> <p>Ø21.5 19 38.5</p> <p>PIN1 — PIN4 PIN2 — PIN3 PIN5 (+) — PIN3 (-)</p>	<p>Illuminated contact block with 5-pole M12 connector, momentary 1 NC + 1 NO Lamp socket none, with integrated 3 mm LED Standard IEC/EN 60947-5-1 M12-5-pol, A-codiert, AIDA FRTL01_C121</p>
 <p>IP00 3 mm</p>	 <p>0 1 2 3 PIN1/PIN2 PIN1/PIN4 PIN3 n.c.</p> <p>Ø21.5 19 37</p> <p>PIN1 — PIN2 PIN1 — PIN4</p>	<p>Contact block with 4-pole M12 connector, momentary 1 NC + 1 NO Standard IEC/EN 60947-5-1 M12-4-pol, A-codiert FRT01_C008</p>
 <p>IP00 3 mm</p>	 <p>0 1 2 3 PIN1/PIN4 PIN2/PIN5 PIN3 n.c.</p> <p>Ø21.5 19 38.5</p> <p>PIN1 — PIN4 PIN2 — PIN5</p>	<p>Contact block with 5-pole M12 connector, momentary 1 NC + 1 NO Standard IEC/EN 60947-5-1 5-pole M12, A coded, AIDA FRT01_C118</p>
 <p>IP00 3 mm</p>	 <p>0 1 2 3 PIN1/PIN4 PIN5/PIN2 PIN5/PIN3</p> <p>Ø21.5 19 38.5</p> <p>PIN1 — PIN4 PIN2 — PIN2 PIN5 — PIN3</p>	<p>Contact block with 5-pole M12 connector, momentary 2 NC + 1 NO Standard IEC/EN 60947-5-1 5-pole M12, A coded, AIDA FRT001_C112</p>

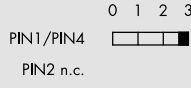
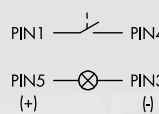
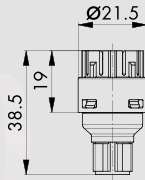

Illustration	Description	Type
--------------	-------------	------

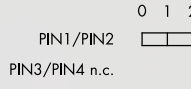
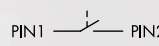
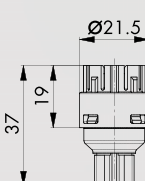
 			<p>Illuminated contact block with 4-pole M12 connector, momentary 1 NO Lamp socket none, with integrated 3 mm LED Standard IEC/EN 60947-5-1</p>	<p>4-pole M12, A coded</p> <p>FRTLI_C005</p>
				

 			<p>Illuminated contact block with 5-pole M12 connector, momentary 1 NO Lamp socket none, with integrated 3 mm LED Standard IEC/EN 60947-5-1</p>	<p>5-pole M12, A coded, AIDA</p> <p>FRTLI_C115</p>
				

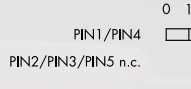
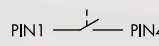
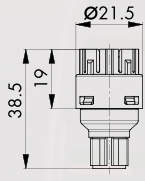
 			<p>Contact block with 4-pole M12 connector, momentary 1 NO Standard IEC/EN 60947-5-1</p>	<p>4-pole M12, A coded</p> <p>FRTI_C007</p>
				

 			<p>Contact block with 5-pole M12 connector, momentary 1 NO Standard IEC/EN 60947-5-1</p>	<p>5-pole M12, A coded, AIDA</p> <p>FRTI_C117</p>
				

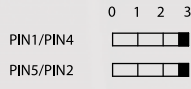
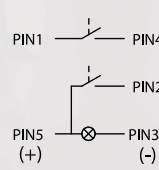
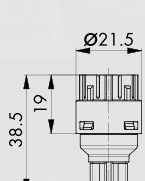
 			<p>Illuminated contact block with 5-pole M12 connector, momentary 2 NO Lamp socket none, with integrated 3 mm LED Standard IEC/EN 60947-5-1</p>	<p>5-pole M12, A coded, AIDA</p> <p>FRTLI_C122</p>
				

Contact blocks FRT connect

MADE IN GERMANY



M12 plugs



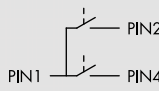
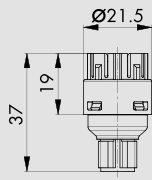

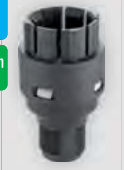

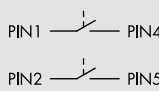
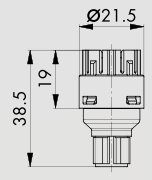



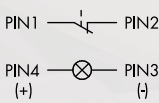
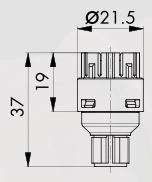



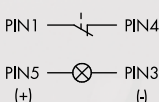
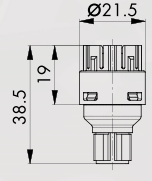



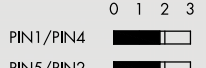
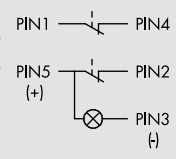
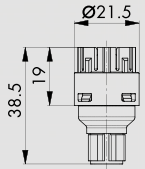

Illustration	Description	Type
 <p>IP00 3 mm</p>	<p>0 1 2 3</p> <p>PIN1/PIN2 </p> <p>PIN1/PIN4 </p> <p>PIN3 n.c.</p>   	<p>Contact block with 4-pole M12 connector, momentary 2 NO Standard IEC/EN 60947-5-1</p> <p>4-pole M12, A coded</p> <p>FRTII_C009</p>
 <p>IP00 3 mm</p>	<p>0 1 2 3</p> <p>PIN1/PIN4 </p> <p>PIN2/PIN5 </p> <p>PIN3 n.c.</p>   	<p>Contact block with 5-pole M12 connector, momentary 2 NO Standard IEC/EN 60947-5-1</p> <p>5-pole M12, A coded, AIDA</p> <p>FRTII_C119</p>
 <p>IP00 3 mm</p> 	<p>0 1 2 3</p> <p>PIN1/PIN2 </p>   	<p>Illuminated contact block with 4-pole M12 connector, momentary 1 NC Lamp socket none, with integrated 3 mm LED Standard IEC/EN 60947-5-1</p> <p>4-pole M12, A coded</p> <p>FRTLO_C004</p>
 <p>IP00 3 mm</p> 	<p>0 1 2 3</p> <p>PIN1/PIN4 </p> <p>PIN2 n.c.</p>   	<p>Illuminated contact block with 5-pole M12 connector, momentary 1 NC Lamp socket none, with integrated 3 mm LED Standard IEC/EN 60947-5-1</p> <p>5-pole M12, A coded, AIDA</p> <p>FRTLO_C114</p>

Illustration Description Type

IP00

3mm

Illuminated contact block with 5-pole M12 connector, momentary

2 NC

Lamp socket none, with integrated 3 mm LED

Standard IEC/EN 60947-5-1



5-pole M12, A coded, AIDA

FRTL00_C113

IP00

3mm

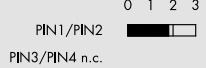
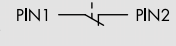
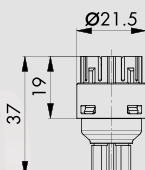

Contact block with 4-pole M12 connector, momentary

1 NC

Standard IEC/EN 60947-5-1



4-pole M12, A coded

FRT0_C006

IP00

3mm

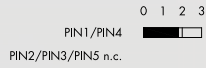
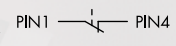
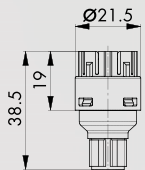

Contact block with 5-pole M12 connector, momentary

1 NC

Standard IEC/EN 60947-5-1



5-pole M12, A coded, AIDA

FRT0_C116

IP00

3mm

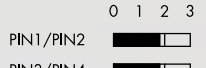
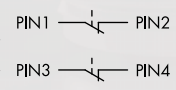
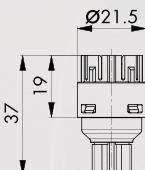

Contact block with 4-pole M12 connector, momentary

2 NC

Standard IEC/EN 60947-5-1



4-pole M12, A coded

FRT00_C001

IP00

3mm

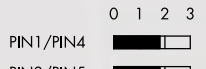
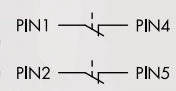
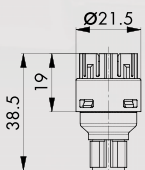

Contact block with 5-pole M12 connector, momentary

2 NC

Standard IEC/EN 60947-5-1

5-pole M12, A coded, AIDA

FRT00_C111





Contact blocks FRT connect





MADE IN GERMANY

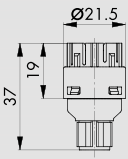

M12 plugs

Illustration	Description	Type
--------------	-------------	------

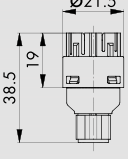
 	 <p data-bbox="702 313 861 369">PIN4 (+) — ⊗ — PIN3 (-)</p> <p data-bbox="702 380 813 414">PIN1/PIN2 n.c.</p> 	<p data-bbox="901 302 1252 347">Lamp element with 4-pole M12 connector</p> <p data-bbox="901 358 1276 414">Lamp socket none, with integrated 3 mm LED</p> <p data-bbox="901 414 1276 448">Standard IEC/EN 60947-5-1</p> <p data-bbox="901 459 1109 492">4-pole M12, A coded</p> <p data-bbox="1300 459 1396 492">FRL_C010</p>
---	--	---

 	 <p data-bbox="702 627 861 683">PIN5 (+) — ⊗ — PIN3 (-)</p> <p data-bbox="702 694 861 728">PIN1/PIN2/PIN4 n.c.</p> 	<p data-bbox="901 616 1252 660">Lamp element with 5-pole M12 connector</p> <p data-bbox="901 672 1276 728">Lamp socket none, with integrated 3 mm LED</p> <p data-bbox="901 728 1276 761">Standard IEC/EN 60947-5-1</p> <p data-bbox="901 772 1173 806">5-pole M12, A coded, AIDA</p> <p data-bbox="1300 772 1396 806">FRL_C120</p>
---	---	---

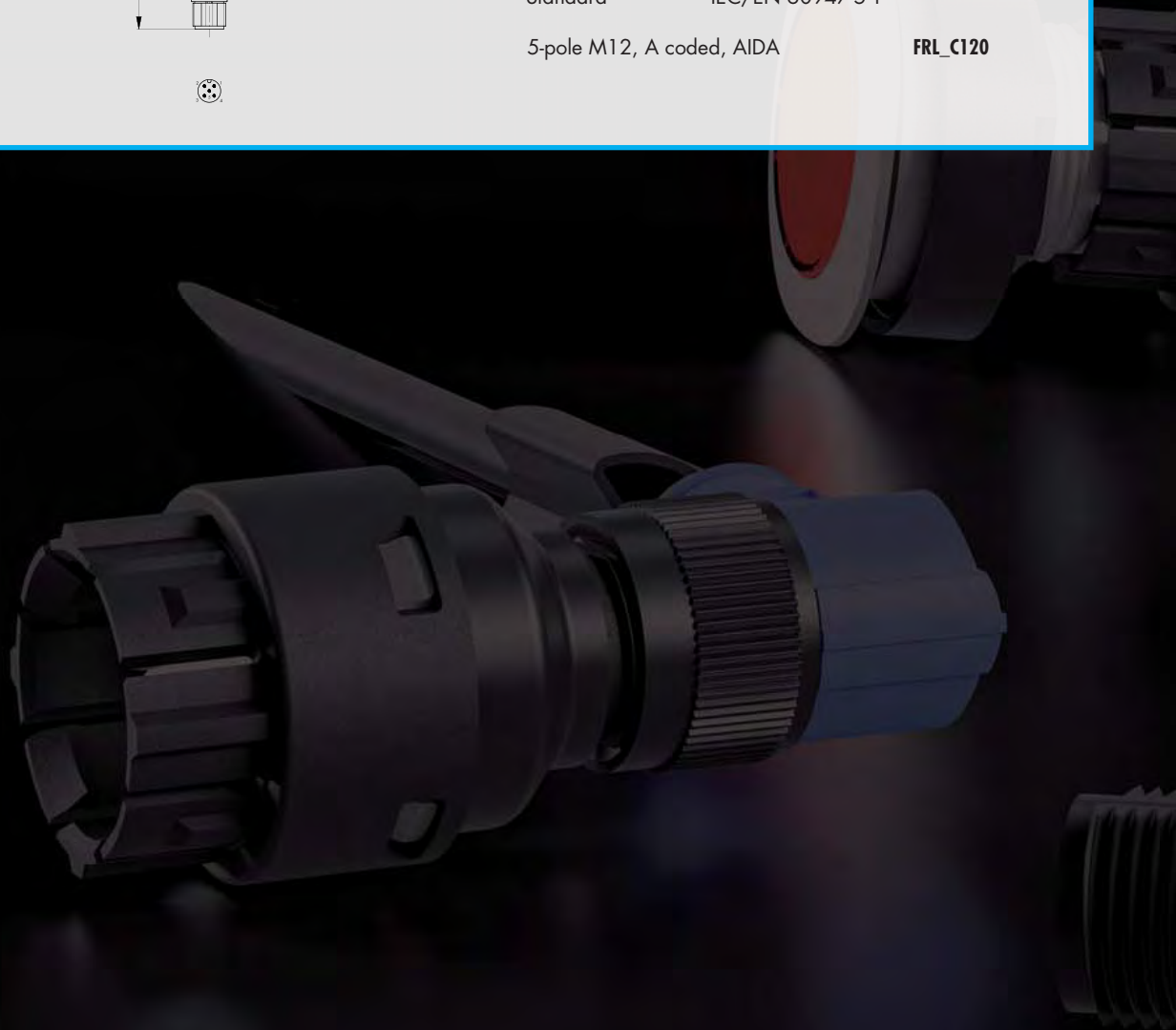



F-RT connect



Georg Schlegel GmbH & Co. KG
Kapellenweg 4
88525 Dürmentingen / Germany

☎ +49 7371 502-0
📠 +49 7371 502 49
@ info@schlegel.biz
www.schlegel.biz



Subsidiaries:

Georg Schlegel Vertriebs Ges.mbH
Samuel Morse-Straße 7
2700 Wiener Neustadt / **Austria**

Tel.: +43 2622 81313
Fax: +43 2622 81313-19
E-Mail: schlegel@schlegel.at
www.schlegel.at